

# Montážní návod

(Montážny návod, Fitting instruction, Montageanleitung,  
Istruzioni di montaggio, Monteringshandledning,  
Asennusohje, Instruction de montage,  
Montagehandleiding, Инструкция по установке)



## Elektropřípojka

Ford Transit Connect 01/2014->06/2018

Elektropřípojka  
Wiring kit  
Trekhaakkabelset  
E-satz  
Faisceau D'attelage  
Barra de remolque  
Wiązka elektryczna  
Vetokoukun vaijerisarja  
Гачковий джгут



výrobce / dodavatel

**SVC Group s.r.o.**

Odkaz na produkt:

<https://www.svcgroup.cz/tazne-zarizeni-sro-uby-pevny-skoda-rapid-monte-carlo-10-2012-2018-p7283-v960>



[www.svcgroup.cz](http://www.svcgroup.cz)

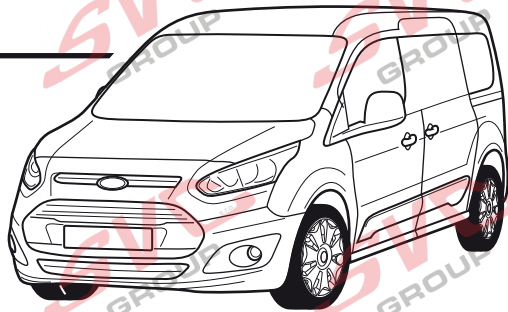

**Ford Transit Connect 01/2014 >>**  
**Ford Tourneo Connect 01/2014 >>**

**Partnr.: FR-066-D1**

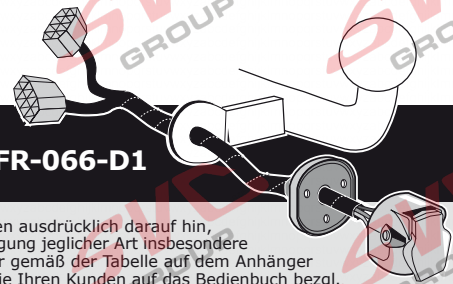

- DE** • Einbauanleitung Elektroersatz Anhängervorrichtung mit 13-P Steckdose lt. DIN/ISO Norm 11446. • Wir weisen ausdrücklich darauf hin, dass eine unsachgemäße und nicht in einer Fachwerkstatt durchgeführte Montage einen Verzicht auf Entschädigung jeglicher Art insbesondere bezüglich des Produkthaftpflichtrechts zur Folge hat. • Technische Änderungen vorbehalten. • Widerstand nur gemäß der Tabelle auf dem Anhänger verwenden. • Achtung! Bitte lesen Sie vorab diese Anleitung, nehmen Sie diese zur Kenntnis und verweisen Sie Ihren Kunden auf das Bedienbuch bezgl. der eventuell zu treffenden Maßnahmen zum Ziehen eines Anhängers. • Bei Funktionsproblemen ist die Fehlersuche auf ca. 0,5 Stunden zu begrenzen, kontaktieren Sie die ECS Technical Support: [ts@ecs-electronics.nl](mailto:ts@ecs-electronics.nl) / 00800 22552327
- FR** • Instructions de montage du faisceau électrique pour crochet d'attelage conforme à la norme DIN/ISO 11446 prise 13-P. • Il est expressément prévu qu' on ne saurait se prévaloir d'un quelconque préjudice contractuel ou réhibitoire si le montage avait été fait en dépit des dites instructions ou dans un garage ne disposant pas des équipements adéquats. • Sous réserve de modifications techniques. • Ne excédez pas la charge maximale, indiquée dans le tableau. • Attention! Avant de commencer le branchement, on vous prie de prendre compte des connexions à faire dans la notice, ainsi que communiquer directement à votre client les mesures à prendre pour tirer une remorque. • S'il y a des problèmes de fonctionnement, limiter la recherche de défauts à env. 30 minutes et contacter ECS l'Aide en ligne: [ts@ecs-electronics.nl](mailto:ts@ecs-electronics.nl) / 00800 22 55 23 27.
- NL** • Montage-handleiding elektrokabelset voor trekhaak met 13-P contactdoos vlg. DIN/ISO norm 11446. • Wij wijzen er met nadruk op, dat ondeskundige en niet door een vakkundige werkplaats uitgevoerde montage tot gevolg heeft dat daardoor ieder recht op schadevergoeding, ook op wettelijke aansprakelijkheid inzake producten, vervalt. • Technische wijzigingen voorbehouden. • Gebruik alleen belasting volgens aansluittabel op het getrokken voertuig. • Opgelet! Wij verzoeken U dringend vooraf deze instructie door te nemen, hiervan kennis te nemen en uw cliënt te verwijzen naar het instructieboekje betreffende de eventueel te nemen maatregelen voor het trekken van een aanhangwagen. • Bij werkingsproblemen moet de foutencontrole tot ca. 0,5 uur beperkt worden, neem contact op met de ECS Technical Support: [ts@ecs-electronics.nl](mailto:ts@ecs-electronics.nl) / 00800 22 55 23 27.
- GB** • Fitting instructions electric wiring kit tow bar with 13-P socket up to DIN/ISO Norm 11446. • We would expressly point out that assembly not carried out properly by a competent installer will result in cancellation of any right to damage compensation, in particular those arising by virtue of the product liability act. • Contents of these kits and their fitting manuals are subject to alteration without notice, please ensure that these instructions are read and fully understood before commencing installation. • Do not overload circuits; the maximum loads per connection are detailed in this manual. • Attention! Before Installation, please read this manual carefully and inform your customer to consult the vehicle owners manual to check for any vehicle modifications required before towing. • In the event of functional problems, troubleshooting must be limited to about 0.5 hours, contact the ECS Technical Support: [ts@ecs-electronics.nl](mailto:ts@ecs-electronics.nl) / 00800 22 55 23 27.
- ES** • Instrucciones de montaje de kit eléctrico para enganche de remolque con caja de conexiones 13-P según norma DIN/ISO 11446. • El montaje inapropiado y efectuado por personal no cualificado originará la pérdida de todo derecho a indemnización o la expiración de toda responsabilidad civil con respecto al producto. • Nos reservamos el derecho a efectuar modificaciones técnicas. • Utilice sólo cargas de acuerdo a la tabla de conexión del vehículo remolcado. • Atención: lea atentamente este manual antes de la instalación e informe al cliente que debe consultar el manual de usuario del vehículo para conocer cualquier modificación realizada. • En caso de tener problemas con su funcionamiento, la búsqueda de errores está limitada a aprox. 0,5 horas, por lo que le recomendamos ponerse en contacto con el servicio de atención telefónica: [ts@ecs-electronics.nl](mailto:ts@ecs-electronics.nl) / 00800 22 55 23 27.
- IT** • Istruzioni di montaggio di set di cavi elettrici per gancio da traino con zoccolo a 13-P conforme alla norma DIN/ISO 11446. • Sottolineiamo espressamente che un montaggio inadeguato ed eseguito da un'officina non specializzata ha come conseguenza il decadere di qualsiasi diritto al risarcimento danni, nonché alla responsabilità legale relativa ai prodotti. • Ci si riserva il diritto di apportare modifiche tecniche. • Utilizzare esclusivamente un carico conforme alla tabella degli allacci relativa al veicolo in questione. • Attenzione! Vi invitiamo a leggere attentamente questo manuale e a invitare a vostra volta i clienti a leggere il manuale del conducente sulle eventuali misure da prendere per l'attacco di un rimorchio. • In caso di problemi di funzionamento, la ricerca di errori dovrebbe essere limitata a circa 0,5 ore. Contattare il centralino di assistenza per i fasci di cavi: [ts@ecs-electronics.nl](mailto:ts@ecs-electronics.nl) / 00800 22 55 23 27.
- SE** • Monteringsanvisningar elkabelsats för dragkrok med 13-P kontaktdosa enligt DIN/ISO norm 11446. • Vi påpekar med eftertryck att all rätt till skadeersättning och all laglig ansvarighet förfaller om monteringen inte har utförts på rätt sätt och av en professionell verkstad. • Tekniska ändringar förbehålles. • Använd endast belastning enligt anslutningstabellen på det dragna fordonet. • Varning! Innan installation, läs den här handboken noga och informera din kund om att läsa fordonets användarhandbok för att undersöka vilka eventuella ändringar som behöver göras på fordonet. • Vid funtionsproblem ska felsökningen begränsas till ca 0,5 timme, kontakta reservdelshelpline [ts@ecs-electronics.nl](mailto:ts@ecs-electronics.nl) / 00800 22 55 23 27.
- CZ** • Montážní pokyny: souprava pro elektrické propojení tažné tyče s 13-P zásuvkou do normy DIN/ISO 11446. • Výslovně zdůrazňujeme, že jakákoli montáž, která není provedená ve specializované dílně, má za následek odvolání nároku na kompenzaci jakéhokoli druhu, obzvláště vyplývajících ze zákona o odpovědnosti za způsobené škody. • Změny mohou být provedeny bez oznámení. • Používejte pouze při maximálním nabití podle tabulky na tažném vozidle. • Upozornění! Prosíme, abyste si nejdříve přečetli tyto instrukce, seznámili se s nimi a odkázali své zákazníky na příručku týkající se případných opatření, která musí být přijata pro tažení přívěsu. • Při problémech funkčnosti je třeba vyhledávání chyb omezit na cca 0,5 hodiny, kontaktujte ECS Technical Support: [ts@ecs-electronics.nl](mailto:ts@ecs-electronics.nl) / 00800 22 55 23 27.
- DK** • Monteringsvejledninger for det elektriske ledningsforingsset for trækstang med 13-P stikdåse, DIN/ISO, norm 11446. • Vi ønsker at gøre udtrykkeligt opmærksom på atfækkert samling, der ikke er udført af et specialiseret værksted, resulterer i bortfaldelse af kompenseringskrav af alle slags, i særdeles krav der måtte opstå omkring det lovligtige ansvar. • Kan ændres uden varsel. • Brug kun den maksimale belastning, i overensstemmelse med forbindelsestabelen for bugserede køretøjer. • OBS! For installation skal denne vejledning læses omhyggeligt og din kunde skal informeres om at kigge i køretøjets håndbog for at kontrollere om der skal laves eventuelle ændringer på køretøjet inden bugsering. • Ved funktionsproblemer skal fejlsøgningen begrænses til ca. 0,5 time, kontakt ECS Technical Support: [ts@ecs-electronics.nl](mailto:ts@ecs-electronics.nl) / 00800 22 55 23 27.
- FI** • Ohjeet vetokoukun sähkökaapelisarjan asentamiseen, jossa on DIN/ISO 11446 mukainen 13-P liitin. • Korostamme, että kaikki oikeudet vahinkokorvaukseen kuten myös valmistajan laillinen vastuu raukeavat, mikäli asennusta ei ole toteutettu oikealla tavalla eikä ammattitaitoisen asiantuntijan toimesta. • Oikeus teknisiin muutoksiin ilman erillistä huomautusta pidätetään. • Huomio! Lue tämä käyttöopas huolellisesti ennen asennusta ja tiedota asiakkaita tarkistamaan kaikki ajoneuvon muutoksen ajoneuvon omistajan käyttöoppaas ennen hinausta. • Kuormita työvirtapiiriä ainoastaan hinattavan ajoneuvon kytkentäkaavin mukaisesti. • Virhehaku on rajoitettava toiminto-ongelmien esiintyessä noin 0,5 tuntiin, ota yhteys ECS Technical Support: [ts@ecs-electronics.nl](mailto:ts@ecs-electronics.nl) / 00800 22 55 23 27.
- GR** • Οδηγίες συναρμολόγησης ηλεκτρικού σετ καλωδίων μήτρας ρυμούλκησης με υποδοχή 13-P μέγχι DIN/ISO Κανόνας 11446. • Επισημαίνουμε κατηγορηματικά ότι οποιαδήποτε εφαλμένη συναρμολόγηση, η οποία δεν έχει πραγματοποιηθεί ειδικό εργαστήριο θα οδηγήσει σε αποποίηση των αξιώσεων επιβολής αποζημιώσεων οποιοδήποτε είδους, ειδικά όσα προκύπτουν από το νόμο ευθύνης προϊόντων. • Μπορεί να τροποποιηθεί χωρίς προηγούμενη ειδοποίηση. • Χρησιμοποιείτε μόνο μέγιστο ηλεκτρικό φορτίο σύμφωνα με τον πίνακα σύνδεσης στο ρυμούλκούμενο όχημα. • Προσοχή! Πριν την εγκατάσταση, διαβάστε το χειρίδιο αυτό προσεκτικά και ενημερώστε τον πελάτη σας να συμβουλευτεί το χειρίδιο ιδιοκτητήτων οχήματος ώστε να ελέγξει τυχόν τροποποιήσεις που απαιτούνται στο όχημα πριν τη ρυμούλκηση. • Σε περίπτωση προβλημάτων λειτουργίας να περιοριστεί η αναζήτηση ασφαλήτων σε περ. 0,5 δευτ., επικοινωνήστε με τη γραμμή υποστήριξης ECS Technical Support: [ts@ecs-electronics.nl](mailto:ts@ecs-electronics.nl) / 00800 22 55 23 27.
- NO** • Monteringsanviser elkabelsett for trekkrok med 13-P koblingsboks ifølge DIN/ISO norm 11446. • Vi påpeker ettertrykkelig at all rett til skadeerstatning og rettslig ansvar forfaller dersom monteringen ikke er blitt utført på riktig måte og av et profesjonelt verksted. • Tekniske endringer forbeholdes. • Overskrid ikke grensene anviset i tilkoblingstabellen på tilhengeren eller det tilkoblede kjøretøyet. • OBS! Les denne bruksanvisningen nøye før installasjon. Be kunden om å rådføre seg med brukerhåndboken for kjøretøyeiere for å sjekke om kjøretøyet må modifiseres før tauing. • Ved funksjonsproblemer må feilsøket begrenses til ca. 0,5 timer, kontakt ECS Technical Support: [ts@ecs-electronics.nl](mailto:ts@ecs-electronics.nl) / 00800 22 55 23 27.
- PL** • Instrukcje montażu zestawu okablowania elektrycznego dyszla holowniczego z 13-P stykowym gniazdem DIN/ISO 11446. • Chcielibyśmy wyraźnie zaznaczyć, iż wszelki nieprawidłowy montaż, który nie jest wykonywany w specjalistycznym warsztacie pociąga za sobą utratę możliwości dochodzenia wszelkiego typu roszczeń, w szczególności tych wynikających z odpowiedzialności producenta za swój produkt. • Podlega zmianom bez powiadomienia. • Używać tylko takiego maksymalnego obciążenia które wynika z tabliczki połączeń holowanego pojazdu. • Uwaga! Przed zainstalowaniem należy dokładnie przeczytać tę instrukcję i poinformować klienta o konieczności sprawdzenia w instrukcji posiadacza pojazdu w celu sprawdzenia przed holowaniem, czy nie wprowadzono do pojazdu jakichkolwiek zmian. • W przypadku problemów ograniczyć wyszukiwanie błędów do ok. 0,5 godziny, skontaktować się z linią serwisową [ts@ecs-electronics.nl](mailto:ts@ecs-electronics.nl) / 00800 22 55 23 27.

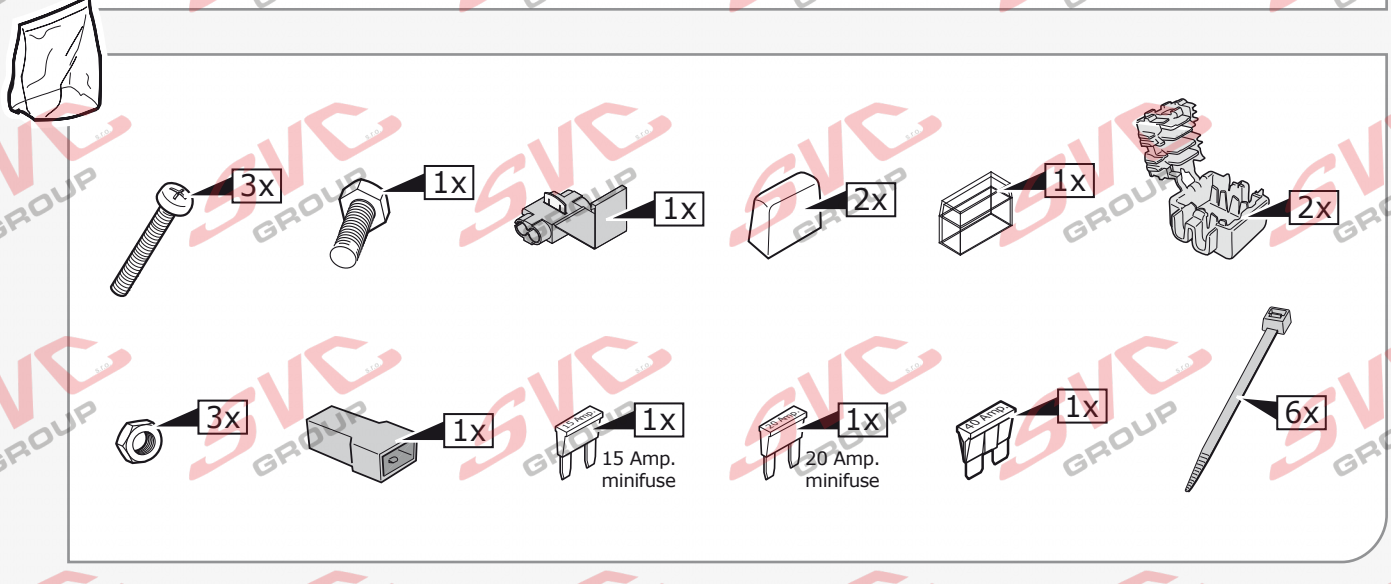
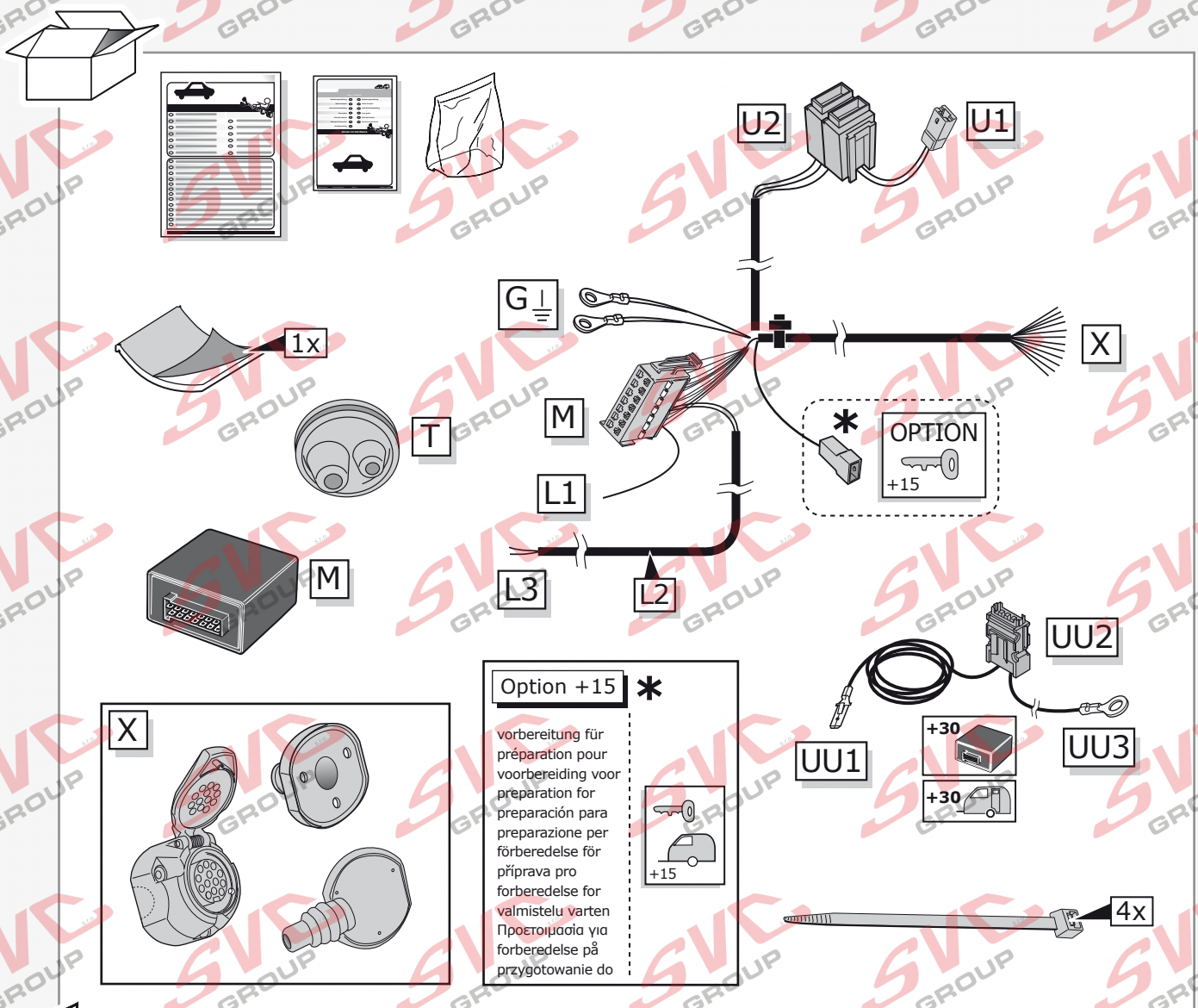

**TOOLS**

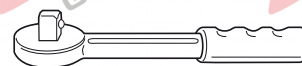
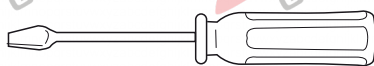
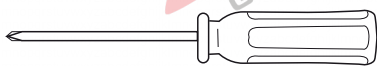

10 mm

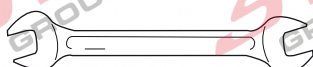
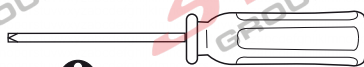

8 mm



**ROUTING**

L1

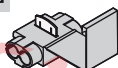

L2



G



M

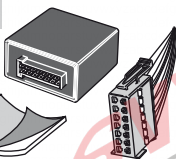

U1



UU1



U2

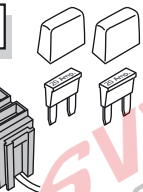

T



X

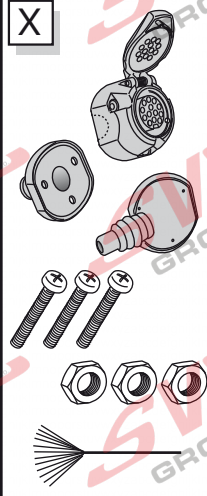

CAN 2A

CAN 1

CAN 2B

UU2

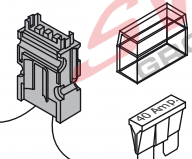

UU3



L3



1

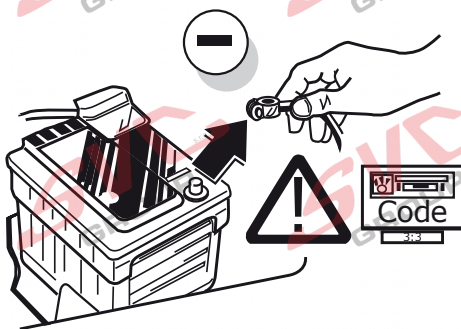

2

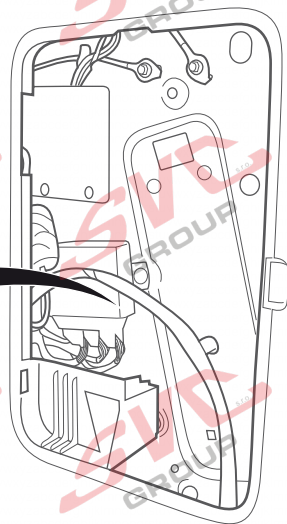
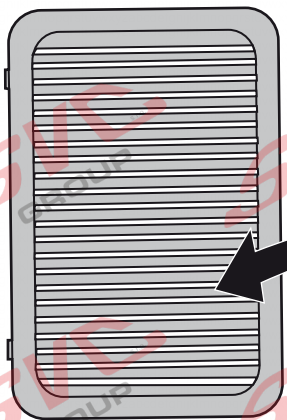
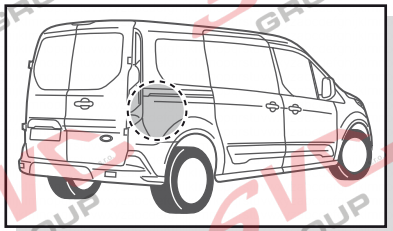

3

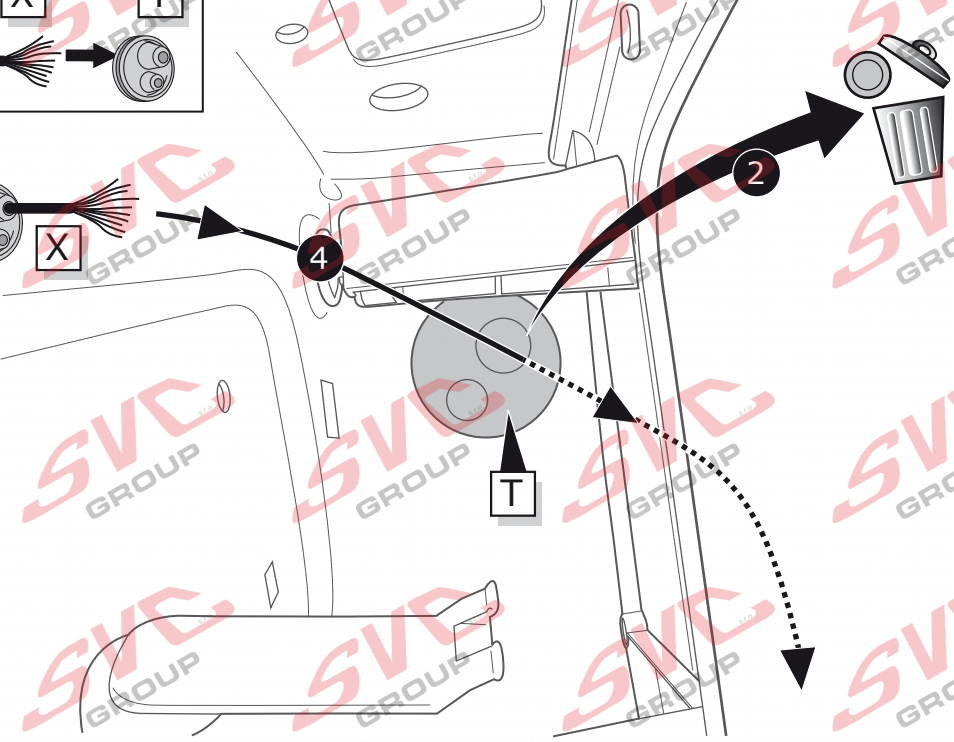
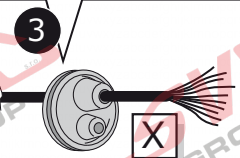
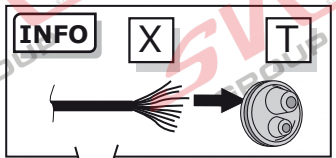
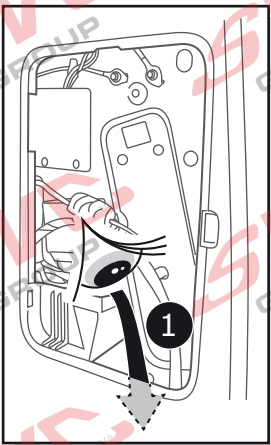

A

Option 1

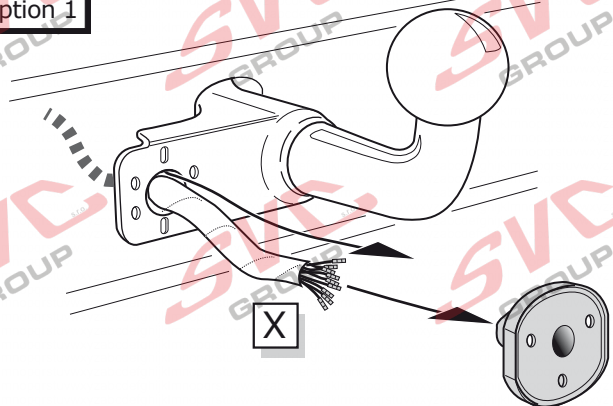

Option 2

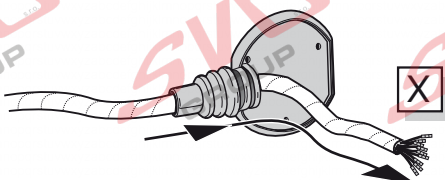

Option 3

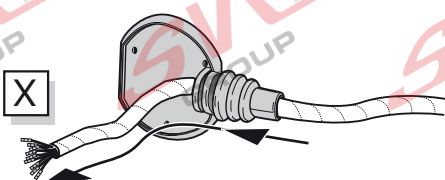

**INFO**

- (DE) Anschluss Steckdose
- (FR) Connection de la prise
- (NL) Contactdoos aansluiting
- (GB) Socket connection
- (ES) Conexión de la caja de enchufe
- (IT) Allaccio zoccolo
- (SE) Anslutning kontaktdosa
- (CZ) Objímkový konektor
- (DK) Stikdåse forbindelse
- (FI) Pistorasia liitäntä
- (GR) Υποδοχή σύνδεσης
- (NO) Tilkobling koblingsboks
- (PL) Połączenie przez gniazdo



Page 15

**B**

Option 1

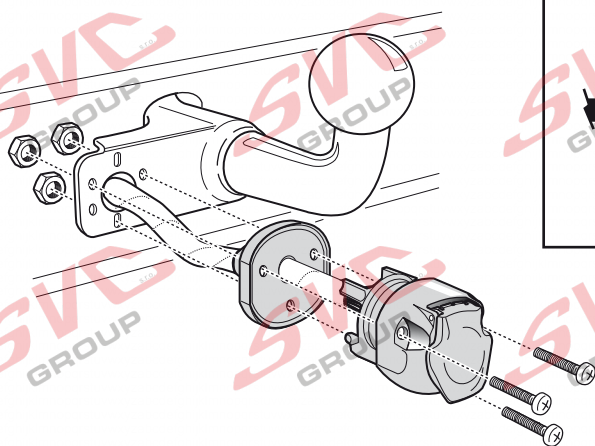

**C**

Option 2

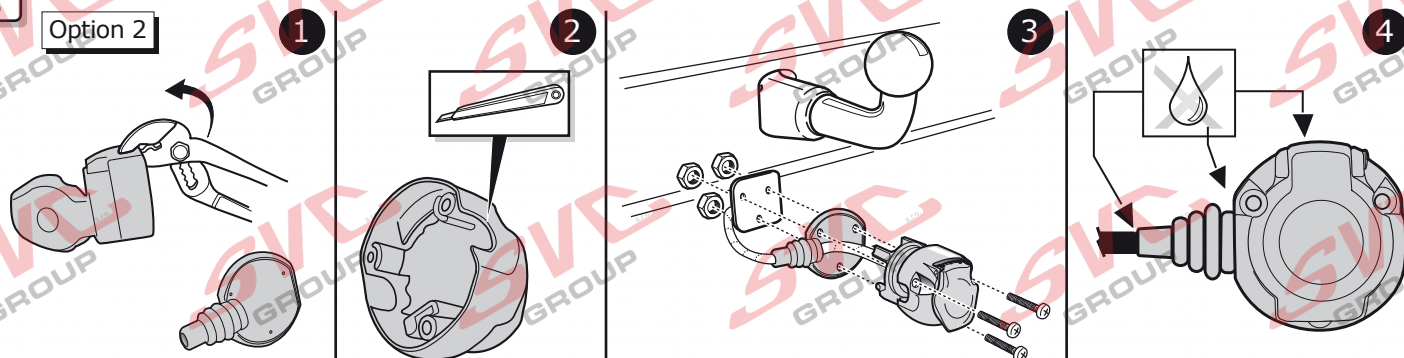

**D**

Option 3

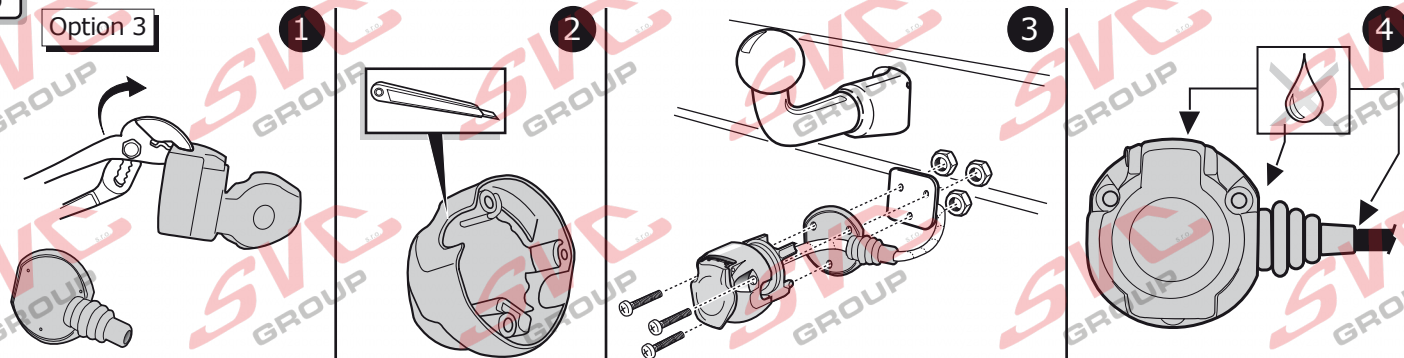

**4**

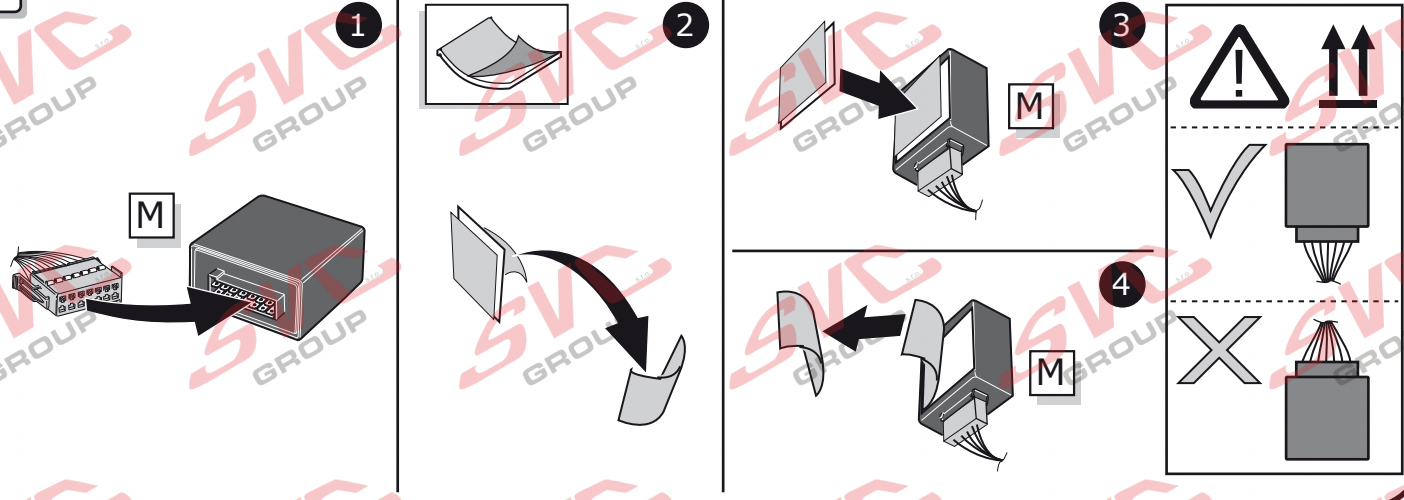

5

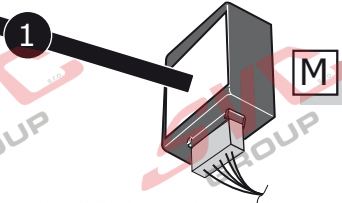
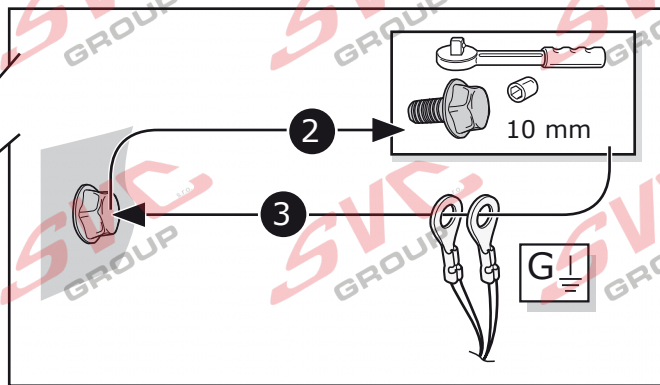
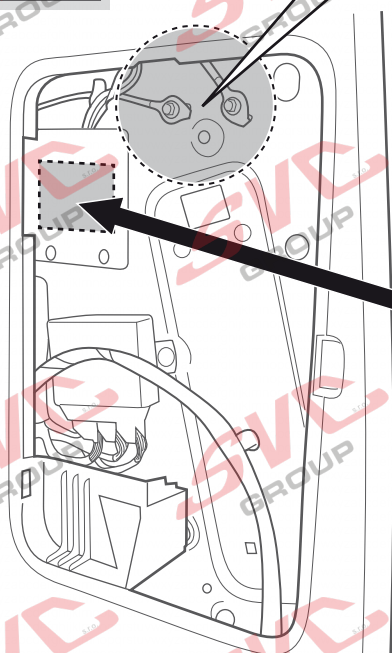
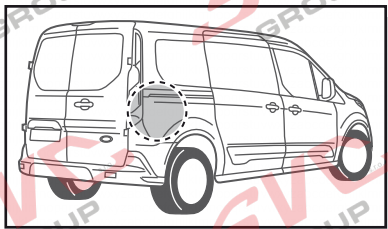

6

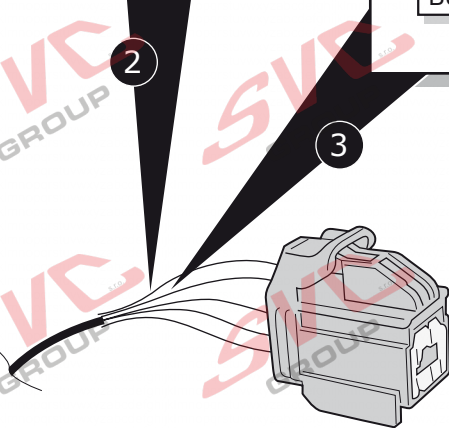
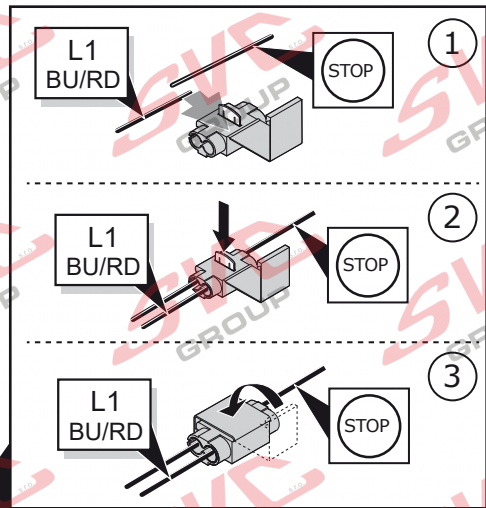
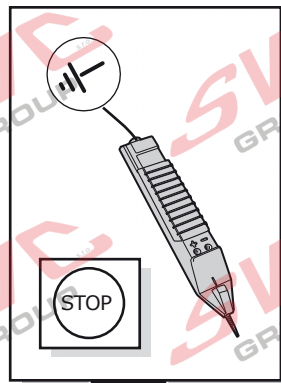
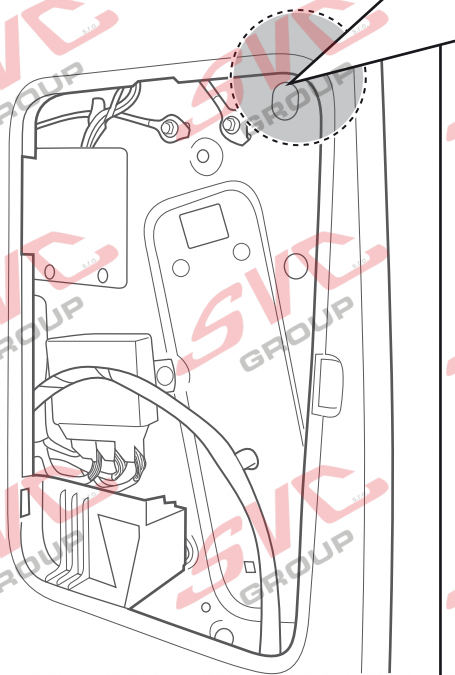
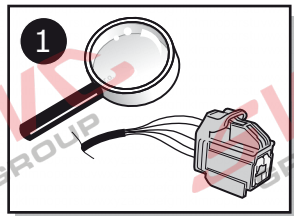

**INFO**

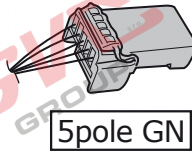
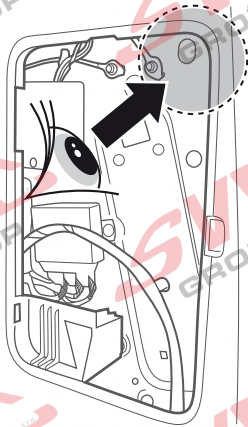

or

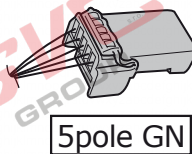
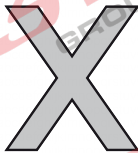
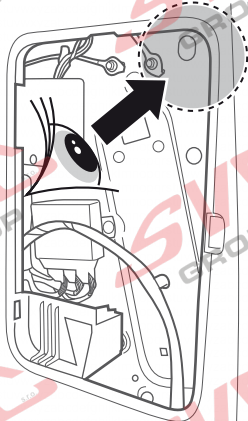
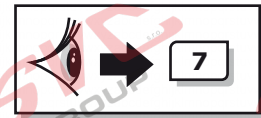
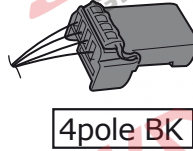

or

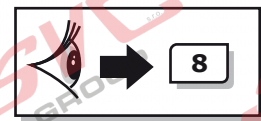
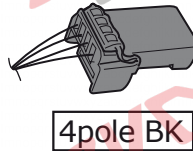

**7**

**OPTION 1**

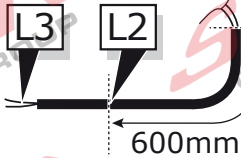

**1**

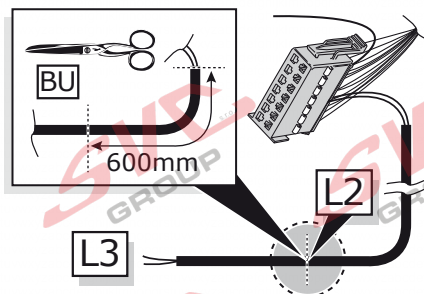

**2**

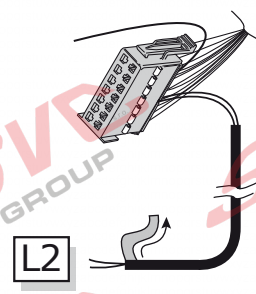

**3**

4pole BK

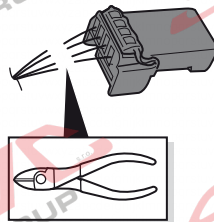

or

5pole GN

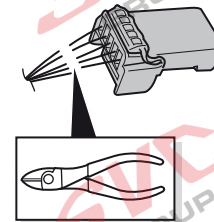

**4**

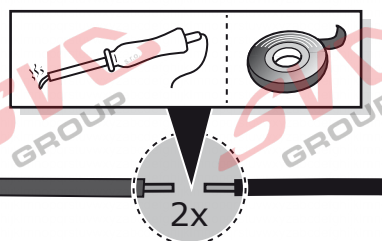

L2	BN	→	GY/OG
L2	GN	→	PE/OG



OPTION 2

L3

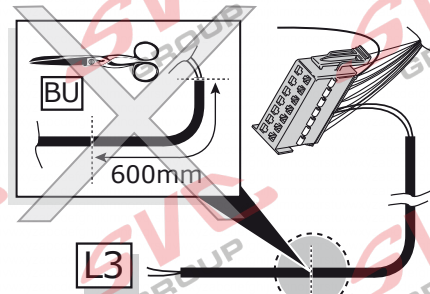
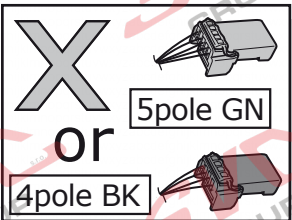

OPTION 2A

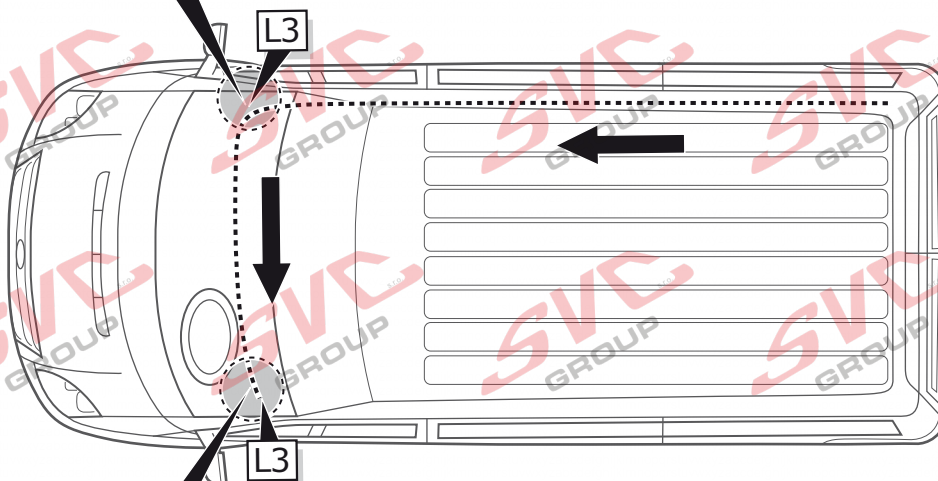

OPTION 2B

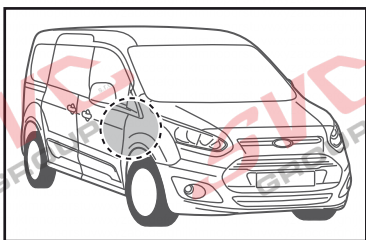

OPTION 2A

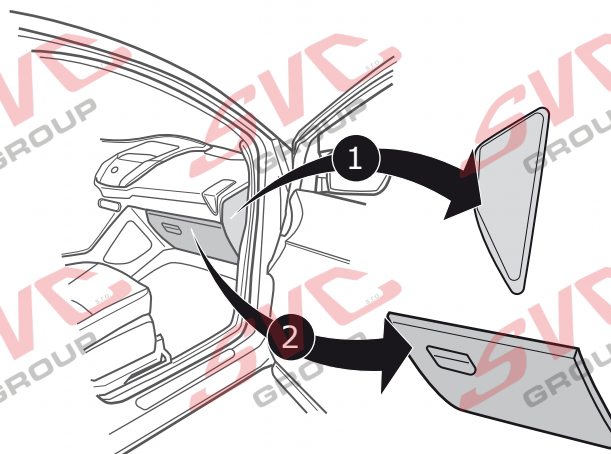

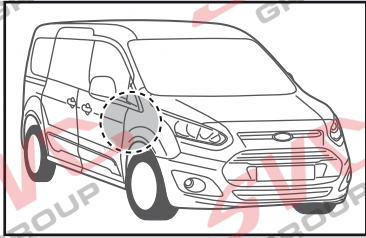

OPTION 2A

CAN-Data Wire

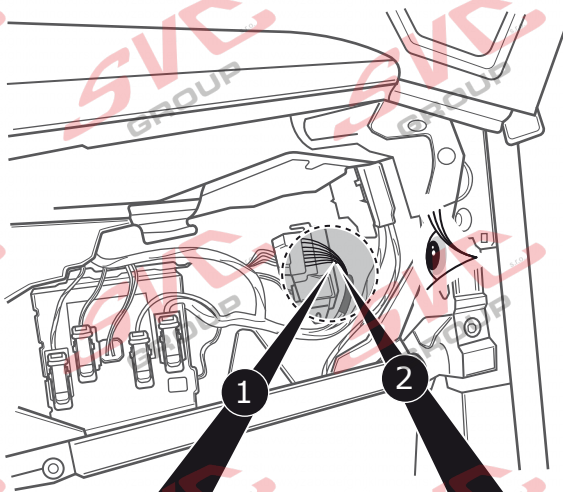
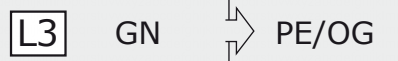
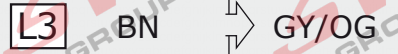
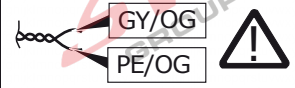

CAN H

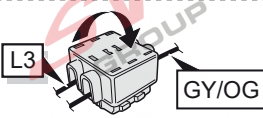
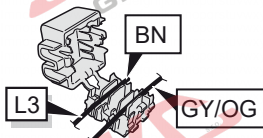

CAN L

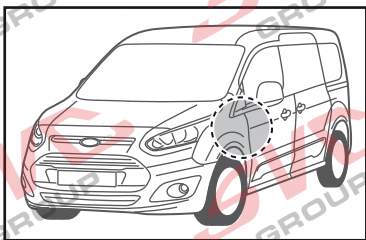
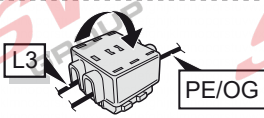
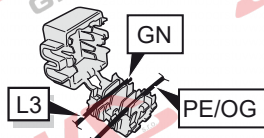

OPTION 2B

CAN-Data Wire

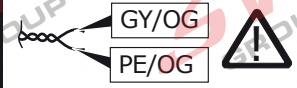

CAN H

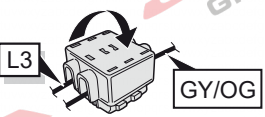
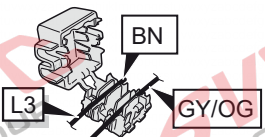

CAN L

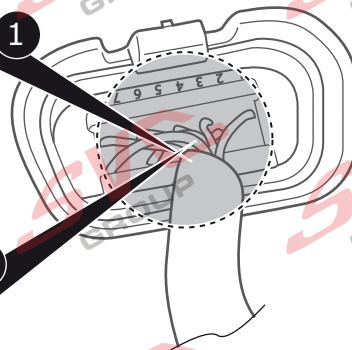
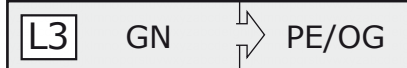
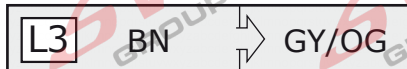
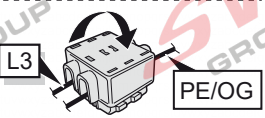
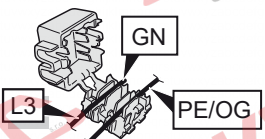

OBDII

**INFO**

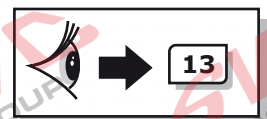
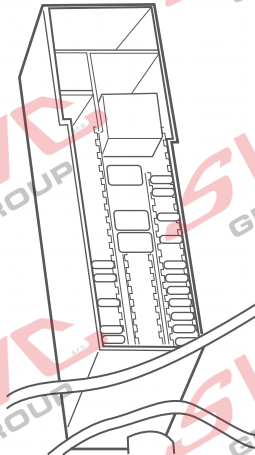
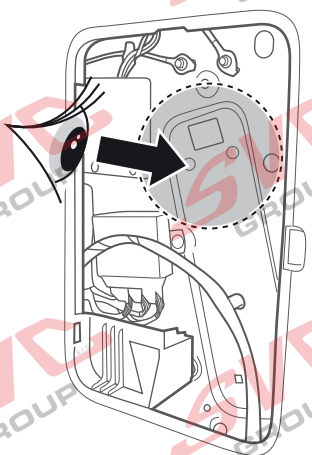
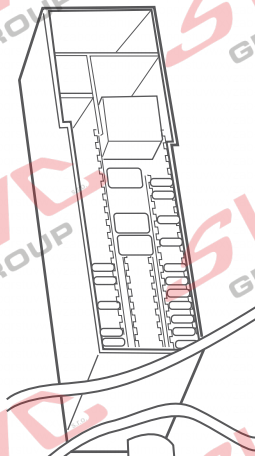
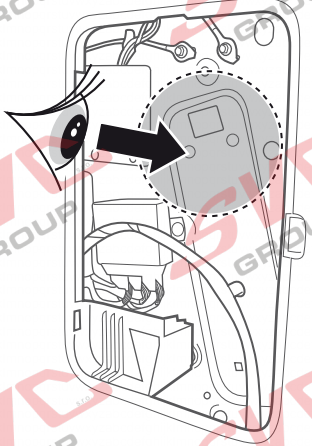

12

**OPTION 1**

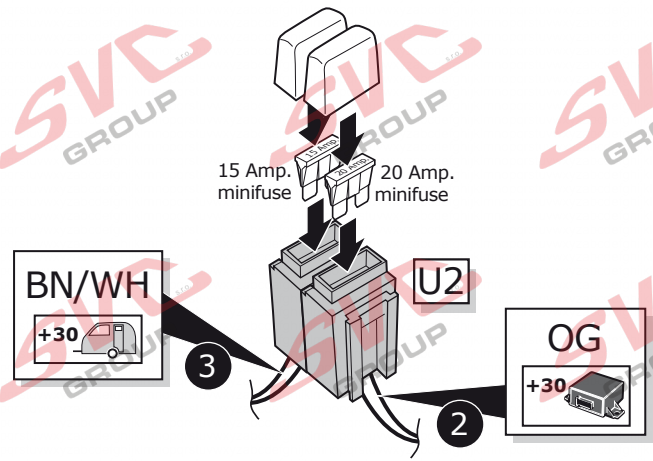
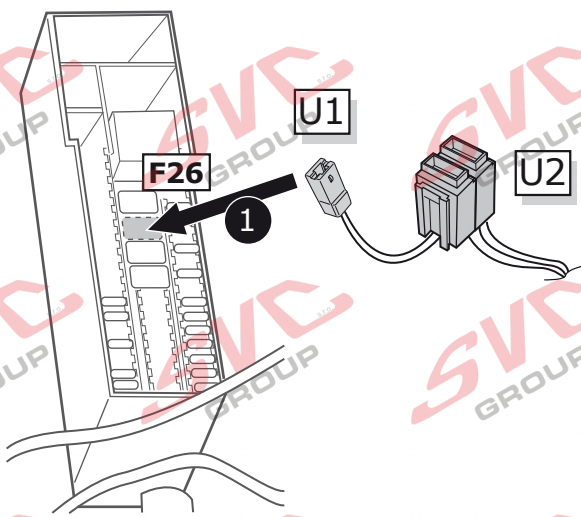
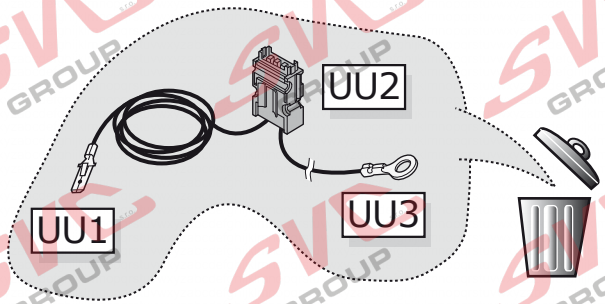
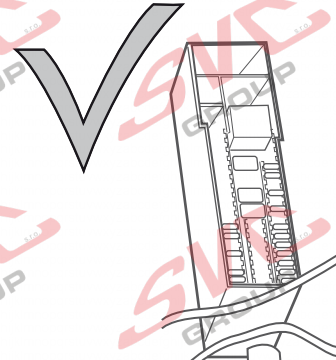
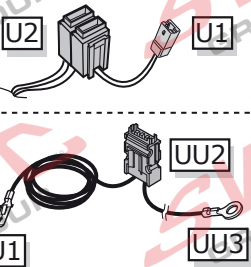

OPTION 2

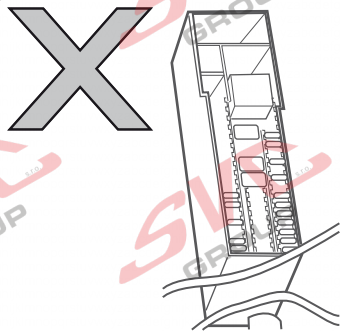
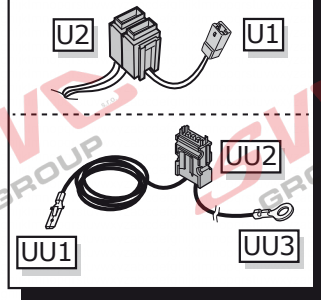

1

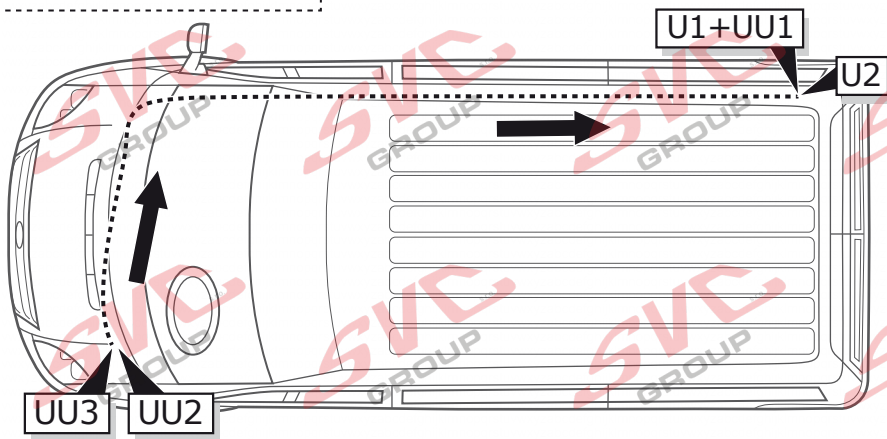

2

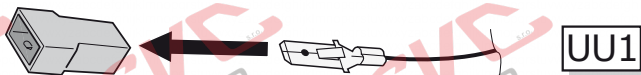

3



4

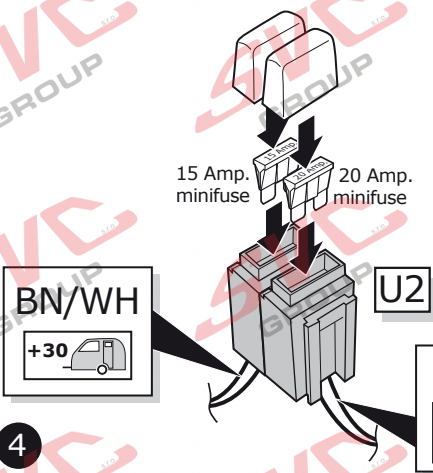

5

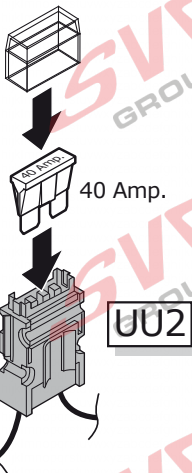

6

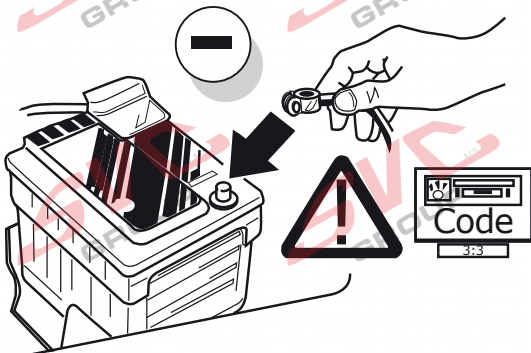
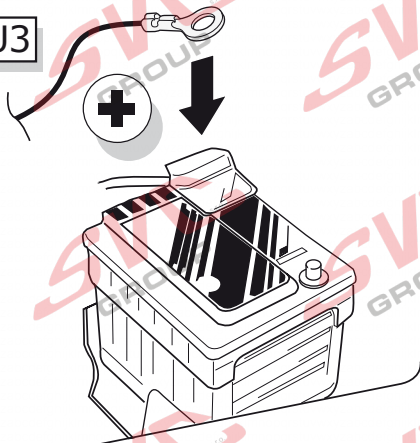

### Manual PDC

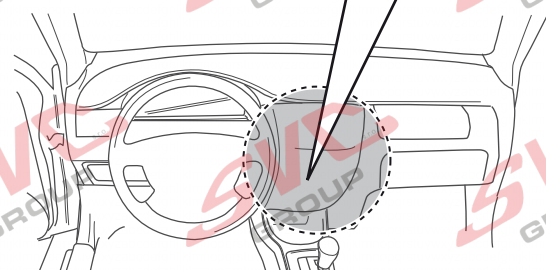
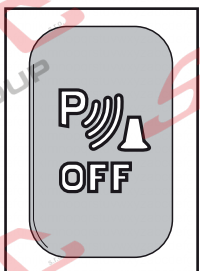
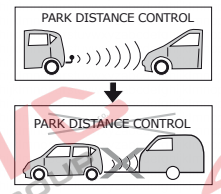

### Option 2

### Auto PDC

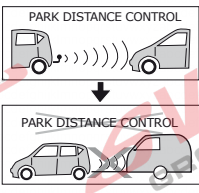

# C2

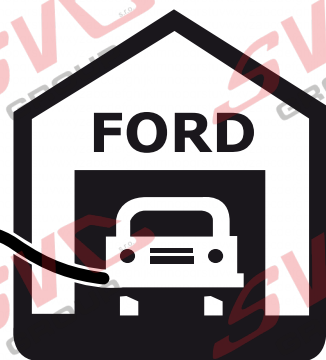
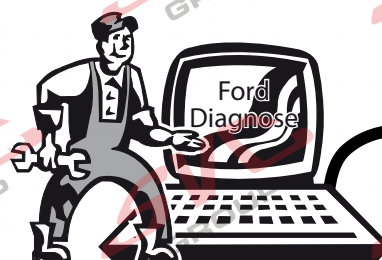

### Functional test

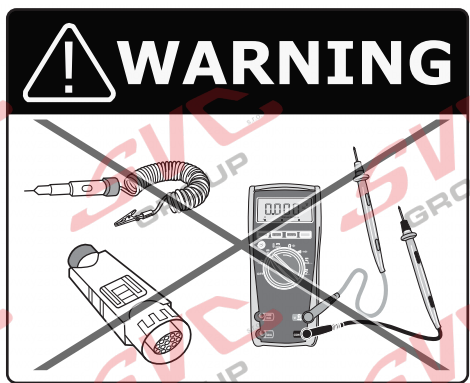
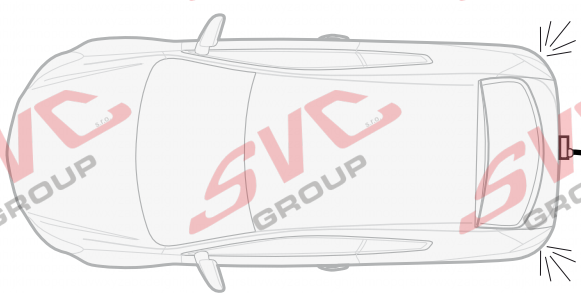
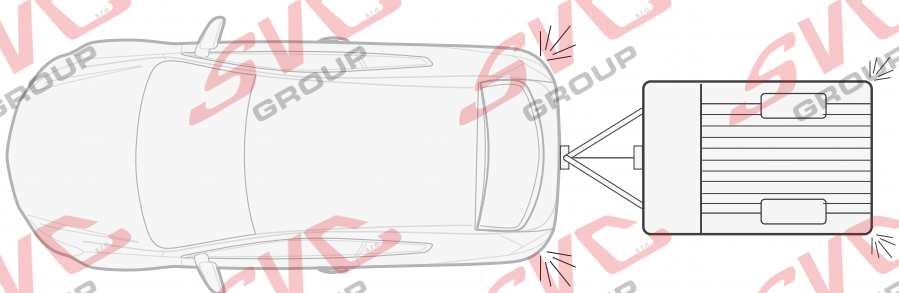
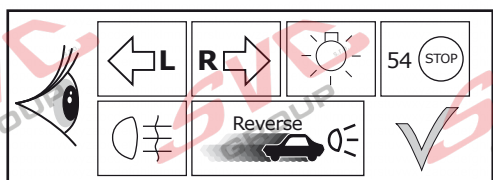

## LIGHTMATE®

**ECS** part no.  
**LIGHTMATEII**  
**LIGHTMATEIII**

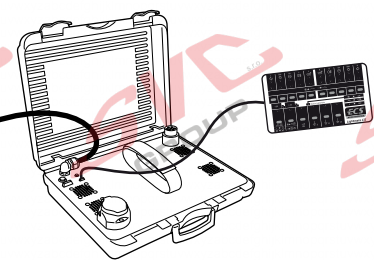

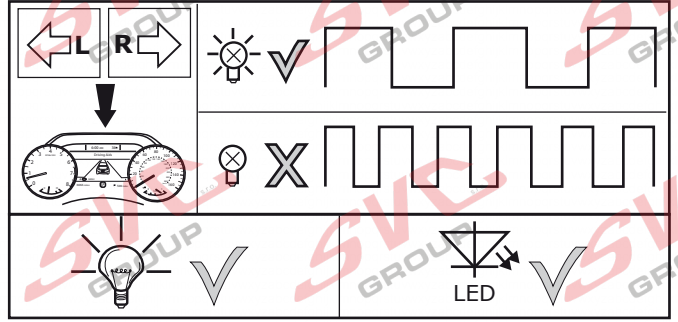

INFO

**Products & Service:** <https://www.ecs-electronics.nl/test-equipment>

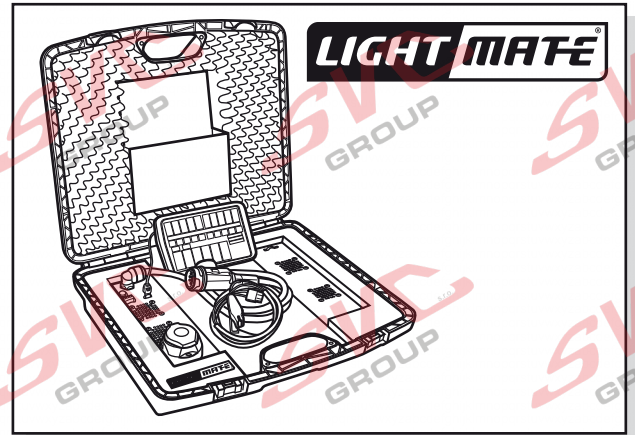
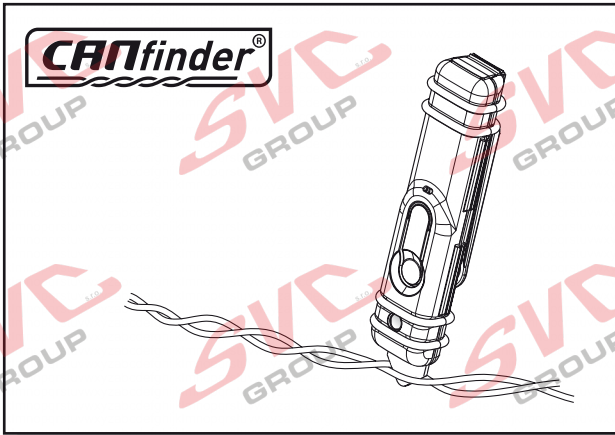

INFO



**FITTERS  
TECHNICAL  
SUPPORT**

**CALL  
FREE  
00800  
2255  
2327**



**MONDAY TO FRIDAY  
08.00 - 12.00  
13.00 - 17.00**

[ts@ecs-electronics.nl](mailto:ts@ecs-electronics.nl)  
[www.ecs-electronics.nl](http://www.ecs-electronics.nl)  
tel: +31 (0)76 573 0020

**INFO**

- (DE) Anschluss Steckdose    (ES) Conexión de la caja de enchufe    (CZ) Objímkový konektor    (GR) Υποδοχή σύνδεσης
- (FR) Connection de la prise    (IT) Allaccio zoccolo    (DK) Stikdåse forbindelse    (NO) Tilkobling koblingsboks
- (NL) Contactdoos aansluiting    (SE) Anslutning kontaktdosa    (FI) Pistorasia liitäntä    (PL) Połączenie przez gniazdo
- (GB) Socket connection

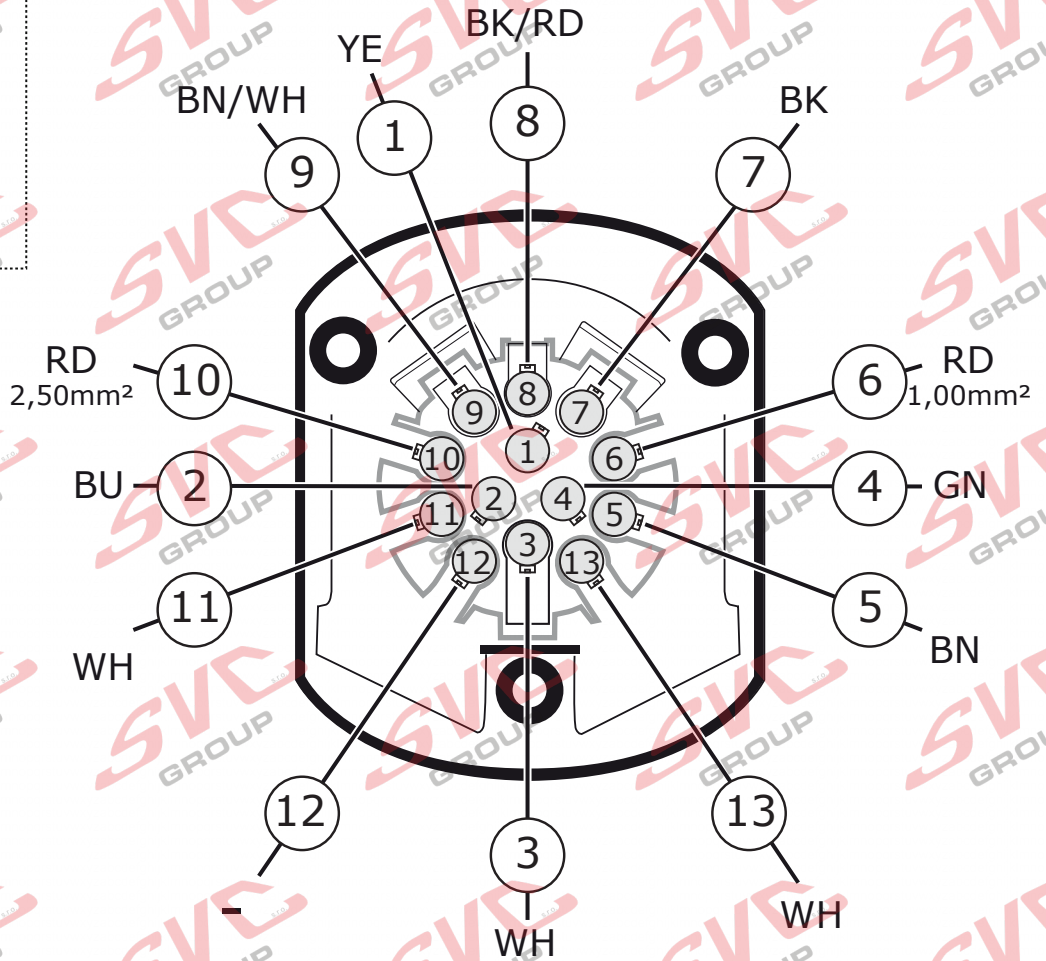
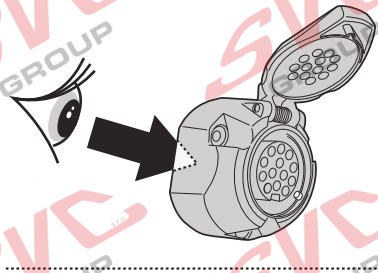

- (DE) Anschluss Steckdose    (ES) Conexión de la caja de enchufe    (CZ) Objímkový konektor    (GR) Υποδοχή σύνδεσης
- (FR) Connection de la prise    (IT) Allaccio zoccolo    (DK) Stikdåse forbindelse    (NO) Tilkobling koblingsboks
- (NL) Contactdoos aansluiting    (SE) Anslutning kontaktdosa    (FI) Pistorasia liitäntä    (PL) Połączenie przez gniazdo
- (GB) Socket connection

DIN/ISO 11446													
Pmax	21W	21W	3/31	21W	42W	3x21W	42W	21W	180W/10Amp	180W/10Amp			
	YE	BU	WH	GN	BN	RD 1,00mm²	BK	BK/RD	BN/WH	RD 2,50mm²	WH	-	WH

**COLORTABLE**

	BK	BN	BU	GY	GN	WH	YE	OG	PE	PI	RD
(DE)	Schwarz	Braun	Blau	Grau	Grün	Weiß	Gelb	Orange	Violett	Rosa	Rot
(FR)	Noir	Marron	Blue	Gris	Vert	Blanc	Jaune	Orange	Violet	Rose	Rouge
(NL)	Zwart	Bruin	Blauw	Grijs	Groen	Wit	Geel	Oranje	Paars	Roze	Rood
(GB)	Black	Brown	Blue	Grey	Green	White	Yellow	Orange	Purple	Pink	Red
(ES)	Negro	Marrón	Azul	Gris	Verde	Blanco	Amarillo	Naranja	Morado	Rosa	Rojo
(IT)	Nero	Marrone	Blu	Grigio	Verde	Bianco	Giallo	Arancione	Viola	Rosa	Rosso
(SE)	Svart	Brun	Blå	Grå	Grön	Vit	Gul	Orange	Lila	Rosa	Röd
(CZ)	Černá	Hnědá	Modrá	Šedá	Zelená	Bílá	Žlutá	Oranžová	Fialová	Růžová	Červená
(DK)	Sort	Brun	Blå	Grå	Grøn	Hvid	Gul	Orange	Lilla	Pink	Rød
(FI)	Musta	Ruskea	Sininen	Harmaa	Vihreä	Valkoinen	Keltainen	Oranssi	Purppura	Vaaleanpunainen	Punainen
(GR)	Μαύρο	Καφέ	Μπλε	Γκρι	Πράσινο	Λευκό	Κίτρινο	Πορτοκαλί	Μοβ	Ροζ	Κόκκινο
(NO)	Svart	Brun	Blå	Grå	Grønn	Hvit	Gul	Oransje	Lilla	Rosa	Rød
(PL)	Czarny	Brazowy	Niebieski	Szary	Zielony	Biały	Żółty	Pomarańczowy	Purpurowy	Różowy	Czerwony



Nevíte si rady? Potřebujete poradit?

# Náš zákaznický servis je vám k dispozici

 +420 491 421 021

 [svc@svcgroup.cz](mailto:svc@svcgroup.cz)



Opravdový specialista a Certifikovaný výrobce tažných zařízení s největším sortimentem v ČR. Rodinná firma s více jak 30letou ověřenou tradicí výroby, prodeje a montáže.

[www.svcgroup.cz](http://www.svcgroup.cz)