

# Montážní návod

(Montážny návod, Fitting instruction, Montageanleitung,  
Istruzioni di montaggio, Monteringshandledning,  
Asennusohje, Instruction de montage,  
Montagehandleiding, Инструкция по установке)



## Elektropřípojka

Mercedes VITO + VIANO serie V-klase 11/2014->

Elektropřípojka  
Wiring kit  
Trekhaakkabelset  
E-satz  
Faisceau D'attelage  
Barra de remolque  
Wiązka elektryczna  
Vetokoukun vaijerisarja  
Гачковий джгут



výrobce / dodavatel

**SVC Group s.r.o.**

Odkaz na produkt:

<https://www.svcgroup.cz/tazne-zarizeni-sro-uby-pevny-skoda-rapid-monte-carlo-10-2012-2018-p7283-v960>



[www.svcgroup.cz](http://www.svcgroup.cz)

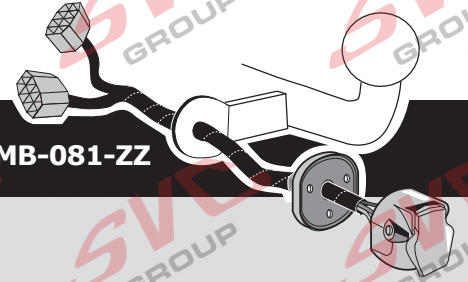
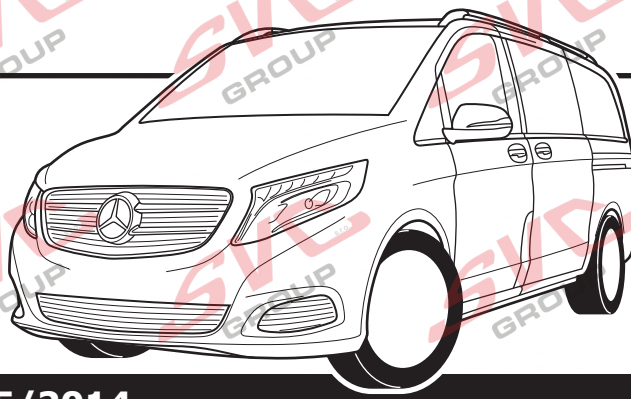

## V-Class W447 05/2014- Vito W447 11/2014-

Partnr.: MB-081-ZZ

- DE** • Ergänzungssatz • Wir weisen ausdrücklich darauf hin, dass eine unsachgemäße und nicht in einer Fachwerkstatt durchgeführte Montage einen Verzicht auf Entschädigung jeglicher Art insbesondere bezüglich des Produkthaftpflichtrechts zur Folge hat. • Technische Änderungen vorbehalten. • Bei Funktionsproblemen ist die Fehlersuche auf ca. 0,5 Stunden zu begrenzen, kontaktieren Sie die ECS Helpline: [ts@ecs-electronics.nl](mailto:ts@ecs-electronics.nl) / 00800 22552327
- FR** • Set d'extension. • Il est expressément prévu qu' on ne saurait se prévaloir d'un quelconque préjudice contractuel ou réhibitoire si le montage avait été fait en dépit des dites instructions ou dans un garage ne disposant pas des équipements adéquats. • Sous réserve de modifications techniques. • S'il y a des problèmes de fonctionnement, limiter la recherche de défauts à env. 30 minutes et contacter ECS l'Aide en ligne: [ts@ecs-electronics.nl](mailto:ts@ecs-electronics.nl) / 00800 22552327.
- NL** • Uitbreidingsset • Wij wijzen er met nadruk op, dat ondeskundige en niet door een vakkundige werkplaats uitgevoerde montage tot gevolg heeft dat daardoor ieder recht op schadevergoeding, ook op wettelijke aansprakelijkheid inzake produkten, vervalt. • Technische wijzigingen voorbehouden. • Bij werkingsproblemen moet de foutencontrole tot ca. 0,5 uur beperkt worden, neem contact op met de ECS Helpline: [ts@ecs-electronics.nl](mailto:ts@ecs-electronics.nl) / 00800 22552327.
- GB** • Extension kit • We would expressly point out that assembly not carried out properly by a competent installer will result in cancellation of any right to damage compensation, in particular those arising by virtue of the product liability act. • Contents of these kits and their fitting manuals are subject to alteration without notice, please ensure that these instructions are read and fully understood before commencing installation. • In the event of functional problems, troubleshooting must be limited to about 0.5 hours, contact the ECS Helpline: [ts@ecs-electronics.nl](mailto:ts@ecs-electronics.nl) / 00800 22552327.
- ES** • Equipo de extensión • El montaje inapropiado y efectuado por personal no cualificado originará la pérdida de todo derecho a indemnización o la expiración de toda responsabilidad civil con respecto al producto. • Nos reservamos el derecho a efectuar modificaciones técnicas. • En caso de tener problemas con su funcionamiento, la búsqueda de errores está limitada a aprox. 0,5 horas, por lo que le recomendamos ponerse en contacto con el servicio de atención telefónica: [ts@ecs-electronics.nl](mailto:ts@ecs-electronics.nl) / 00800 22552327.
- IT** • Set di ampliamento • Sottolineiamo espressamente che un montaggio inadeguato ed eseguito da un'officina non specializzata ha come conseguenza il decadere di qualsiasi diritto al risarcimento danni, nonché alla responsabilità legale relativa ai prodotti. • Ci si riserva il diritto di apportare modifiche tecniche. • In caso di problemi di funzionamento, la ricerca di errori dovrebbe essere limitata a circa 0,5 ore. Contattare il centralino di assistenza per i fasci di cavi: [ts@ecs-electronics.nl](mailto:ts@ecs-electronics.nl) / 00800 22552327.
- SE** • Förlängningsset • Vi påpekar med eftertryck att all rätt till skadeersättning och all laglig ansvarighet förfaller om monteringen inte har utförts på rätt sätt och av en professionell verkstad. • Tekniska ändringar förbehålles. • Vid funtionsproblem ska felsökningen begränsas till ca 0,5 timme, kontakta reservdels-helpline [ts@ecs-electronics.nl](mailto:ts@ecs-electronics.nl) / 00800 22552327.
- CZ** • Prodlužovací souprava • Výslovně zdůrazňujeme, že jakákoli montáž, která není provedená ve specializované dílně, má za následek odvolání nároků na kompenzaci jakéhokoli druhu, obzvláště vyplývajících ze zákona o odpovědnosti za způsobené škody. • Změny mohou být provedeny bez oznámení. • Při problémech funkčnosti je třeba vyhledávání chyb omezit na cca 0,5 hodiny, kontaktujte ECS Helpline: [ts@ecs-electronics.nl](mailto:ts@ecs-electronics.nl) / 00800 22552327.
- DK** • Forlængelsesæt • Vi ønsker at gøre udtrykkeligt opmærksom på atforkert samling, der ikke er udført af et specialiseret værksted, resulterer i bortfaldelse af kompenseringskrav af alle slags, i særdeles krav der måtte opstå omkring det lovplichtige ansvar. • Kan ændres uden varsel. • Ved funktionsproblemer skal fejlsøgningen begrænses til ca. 0,5 time, kontakt ECS Helpline: [ts@ecs-electronics.nl](mailto:ts@ecs-electronics.nl) / 00800 22552327.
- FI** • Lisäsarja • Korostamme, että kaikki oikeudet vahinkokorvaukseen kuten myös valmistajan laillinen vastuu raukeavat, mikäli asennusta ei ole toteutettu oikealla tavalla eikä ammattitaitoisen asiantuntijan toimesta. • Oikeus tekniisiin muutoksiin ilman erillistä huomautusta pidätetään. • Virrehaku on rajoitettava toimintotilanteiden esiintyessä noin 0,5 tuntiin, ota yhteys ECS Helpline: [ts@ecs-electronics.nl](mailto:ts@ecs-electronics.nl) / 00800 22552327.
- GR** • εξάρτηση επέκτασης • Επισημαίνουμε κατηγορηματικά ότι οποιαδήποτε εσφαλμένη συναρμολόγηση, η οποία δεν έχει πραγματοποιηθεί ειδικό εργαστήριο θα οδηγήσει σε αποποίηση των αξιώσεων επιβολής αποζημιώσεων οποιασδήποτε είδους, ειδικά όσα προκύπτουν από το νόμο ευθύνης προϊόντων. • Μπορεί να τροποποιηθεί χωρίς προηγούμενη ειδοποίηση. • Σε περίπτωση προβλημάτων λειτουργίας να περιοριστεί η αναζήτηση σφαλμάτων σε περ. 0,5 δευτ., επικοινωνήστε με τη γραμμή υποστήριξης ECS Helpline: [ts@ecs-electronics.nl](mailto:ts@ecs-electronics.nl) / 00800 22552327.
- NO** • Påbyggingssett • Vi påpeker ettertrykkelig at all rett til skadeerstatning og rettslig ansvar forfaller dersom monteringen ikke er blitt utført på riktig måte og av et profesjonelt verksted. • Tekniske endringer forbeholdes. • Ved funksjonsproblemer må feilsøket begrenses til ca. 0,5 timer, kontakt ECS Helpline: [ts@ecs-electronics.nl](mailto:ts@ecs-electronics.nl) / 00800 22552327.
- PL** • Zestaw rozszerzający • Chcielibyśmy wyraźnie zaznaczyć, iż wszelki nieprawidłowy montaż, który nie jest wykonywany w specjalistycznym warsztacie pociąga za sobą utratę możliwości dochodzenia wszelkiego typu roszczeń, w szczególności tych wynikających z odpowiedzialności producenta za swój produkt. • Podlega zmianom bez powiadomienia. • W przypadku problemów ograniczyć wyszukiwanie błędów do ok. 0,5 godziny, skontaktować się z linią serwisową [ts@ecs-electronics.nl](mailto:ts@ecs-electronics.nl) / 00800 22552327.

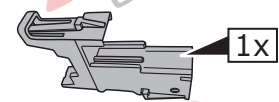
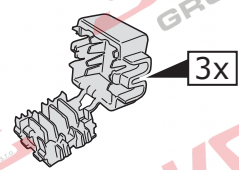
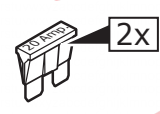
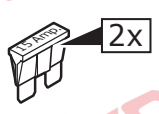
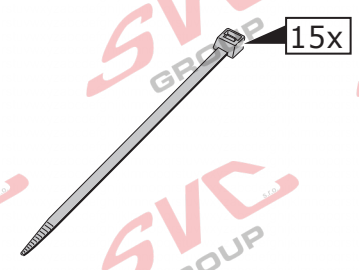
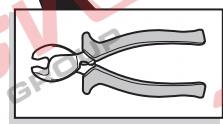
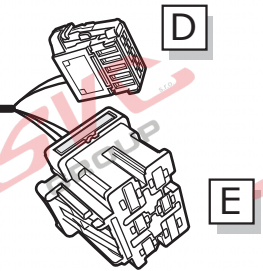
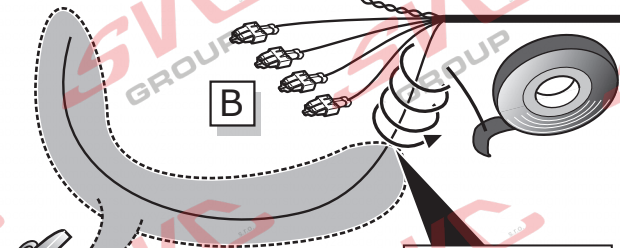
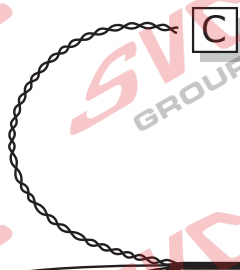
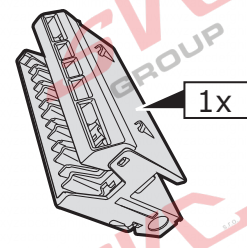
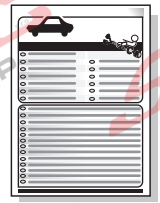
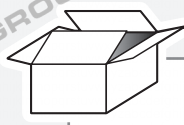

**INFO**

|    | BK      | BN      | BU        | GY     | GN      | WH        | YE        | OG           | PE        | PI              | RD       |
|----|---------|---------|-----------|--------|---------|-----------|-----------|--------------|-----------|-----------------|----------|
| DE | Schwarz | Braun   | Blau      | Grau   | Grün    | Weiß      | Gelb      | Orange       | Violett   | Rosa            | Rot      |
| FR | Noir    | Marron  | Blue      | Gris   | Vert    | Blanc     | Jaune     | Orange       | Violet    | Rose            | Rouge    |
| NL | Zwart   | Bruin   | Blauw     | Grijs  | Groen   | Wit       | Geel      | Oranje       | Paars     | Roze            | Rood     |
| GB | Black   | Brown   | Blue      | Grey   | Green   | White     | Yellow    | Orange       | Purple    | Pink            | Red      |
| ES | Negro   | Marrón  | Azul      | Gris   | Verde   | Blanco    | Amarillo  | Naranja      | Morado    | Rosa            | Rojo     |
| IT | Nero    | Marrone | Blu       | Grigio | Verde   | Bianco    | Giallo    | Arancione    | Viola     | Rosa            | Rosso    |
| SE | Svart   | Brun    | Blå       | Grå    | Grön    | Vit       | Gul       | Orange       | Lila      | Rosa            | Röd      |
| CZ | Černá   | Hnědá   | Modrá     | Šedá   | Zelená  | Bílá      | Žlutá     | Oranžová     | Fialová   | Růžová          | Červená  |
| DK | Sort    | Brun    | Blå       | Grå    | Grøn    | Hvid      | Gul       | Orange       | Lilla     | Pink            | Rød      |
| FI | Musta   | Ruskea  | Sininen   | Harmaa | Vihreä  | Valkoinen | Keltainen | Oranssi      | Purppura  | Vaaleanpunainen | Punainen |
| GR | Μαύρο   | Καφέ    | Μπλε      | Γκρι   | Πράσινο | Λευκό     | Κίτρινο   | Πορτοκαλί    | Μοβ       | Ροζ             | Κόκκινο  |
| NO | Svart   | Brun    | Blå       | Grå    | Grønn   | Hvit      | Gul       | Oransje      | Lilla     | Rosa            | Rød      |
| PL | Czarny  | Brazowy | Niebieski | Szary  | Zielony | Biały     | Zółty     | Pomarańczowy | Purpurowy | Różowy          | Czerwony |

**ROUTING**

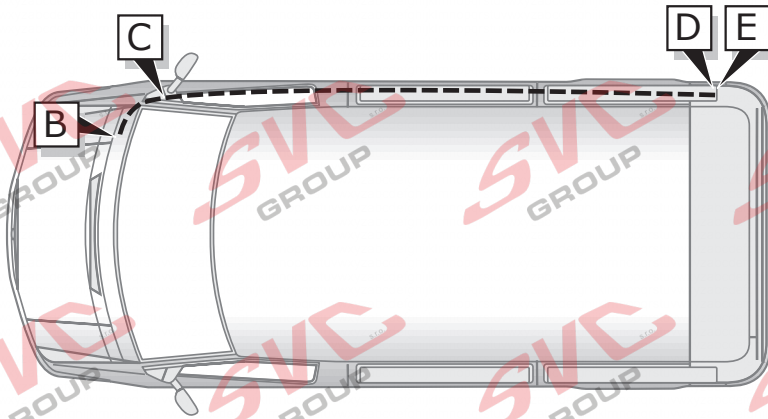

1

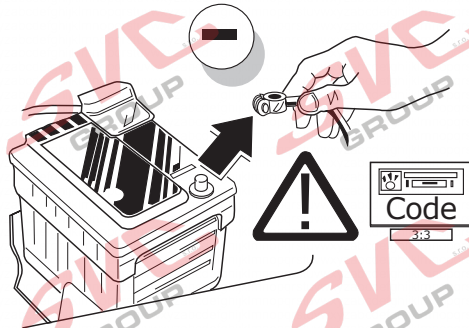

2

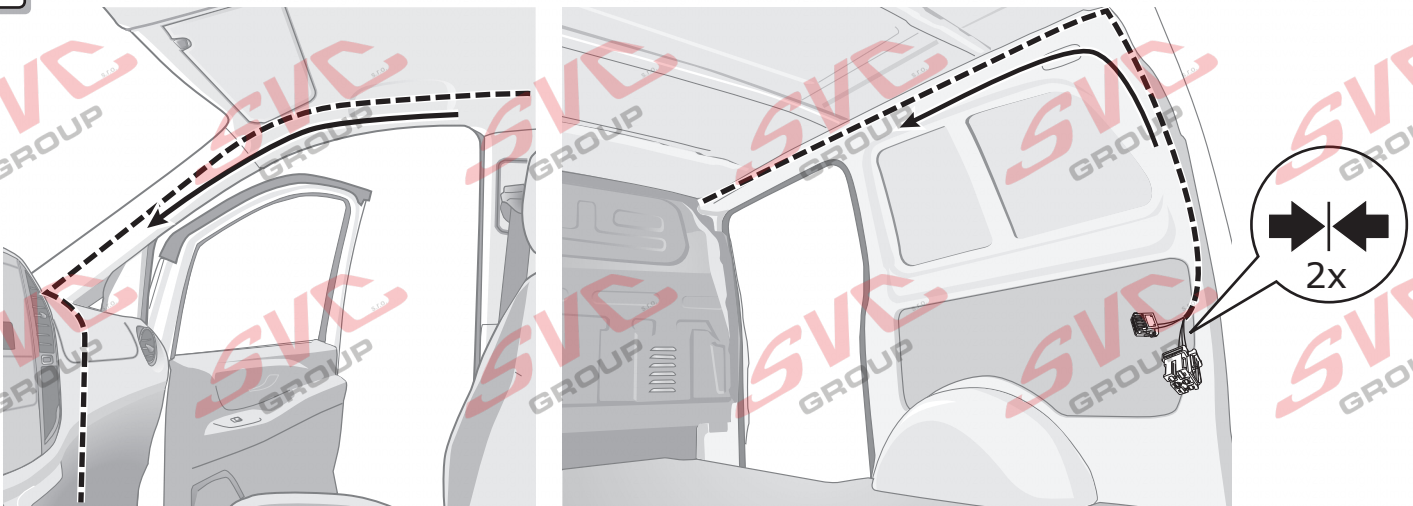

3

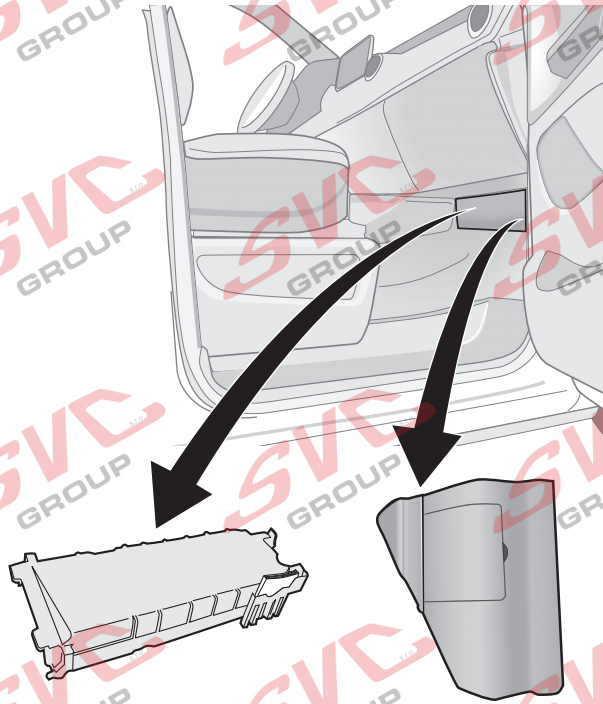
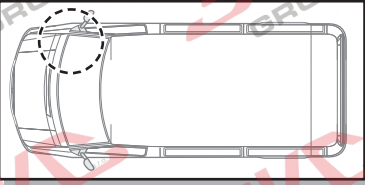

4

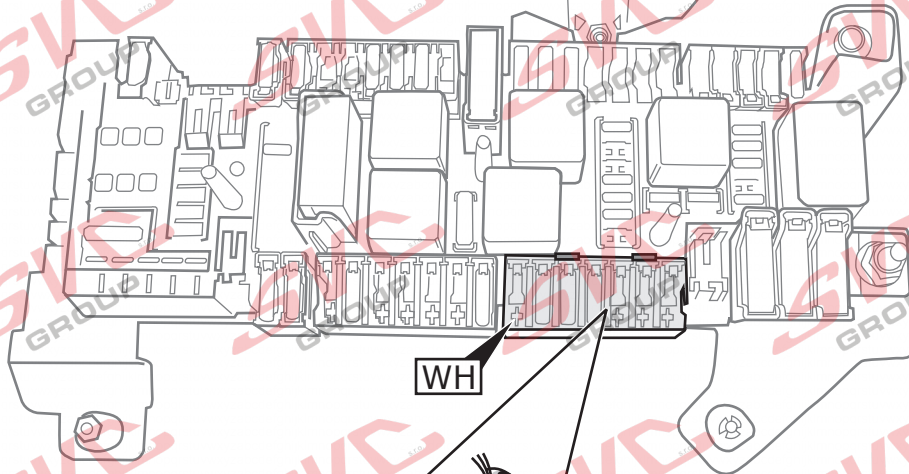

WH

WH

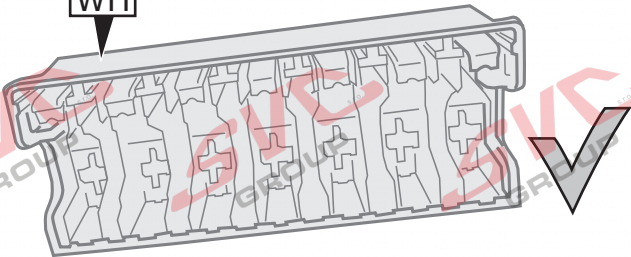

WH

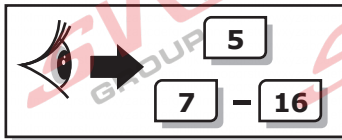
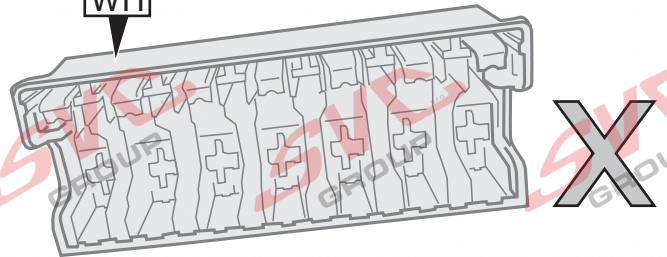

5

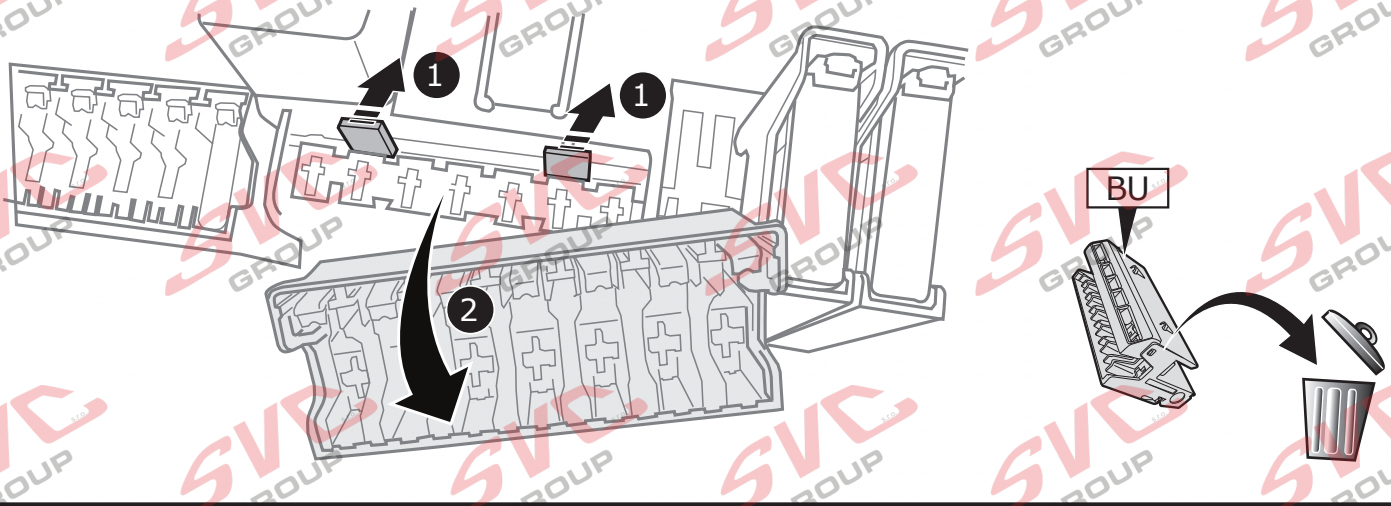

6

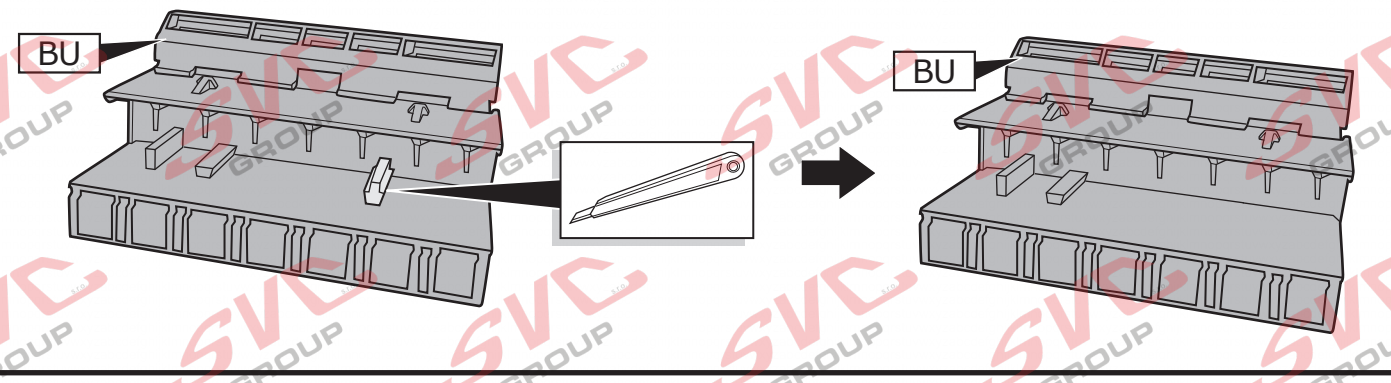

7

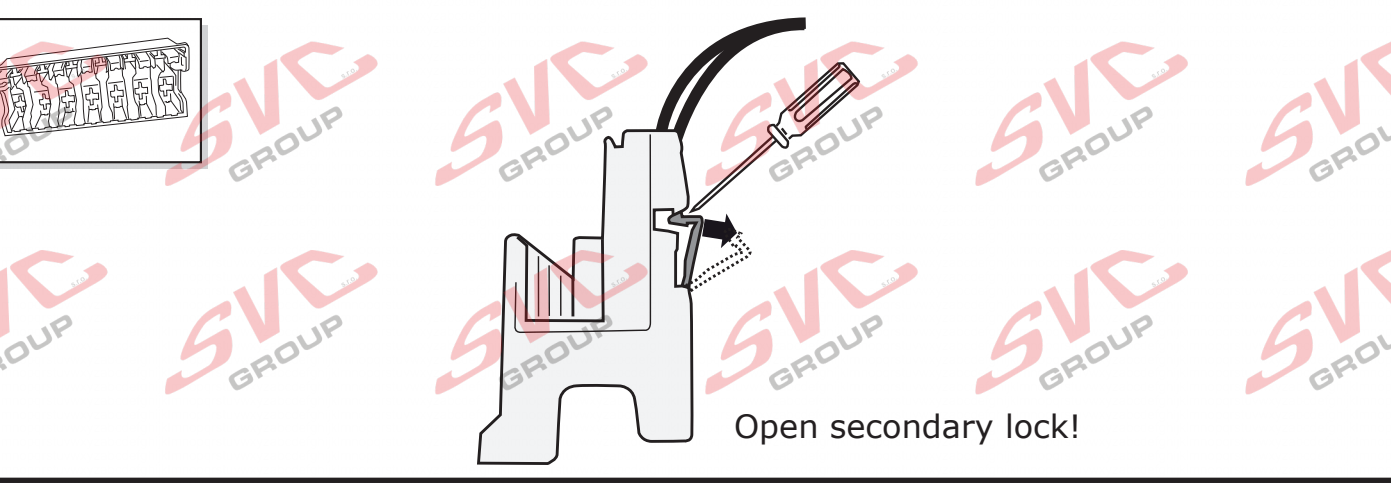

8

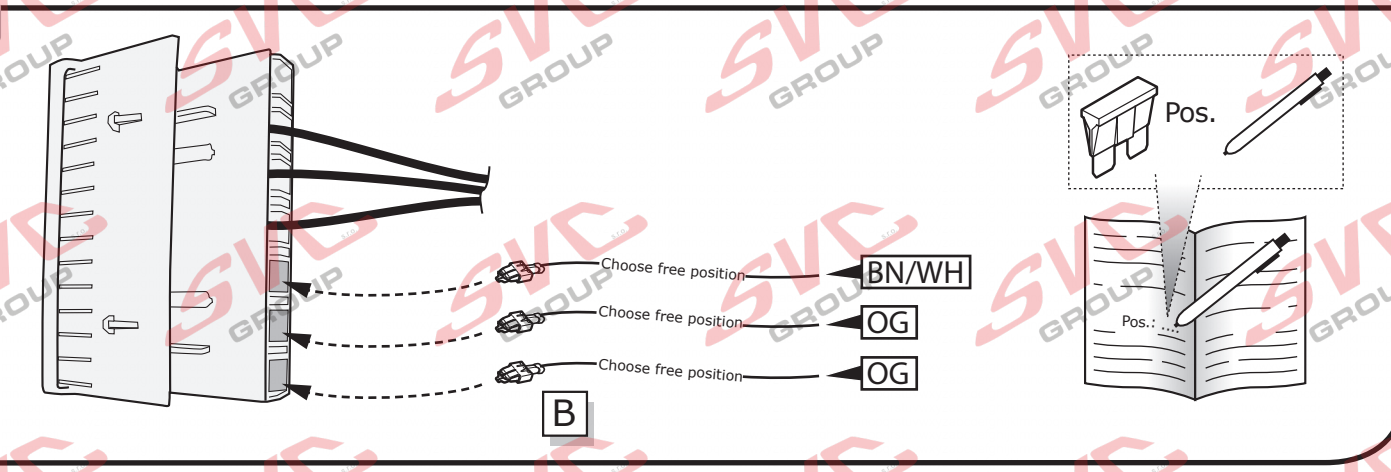

9

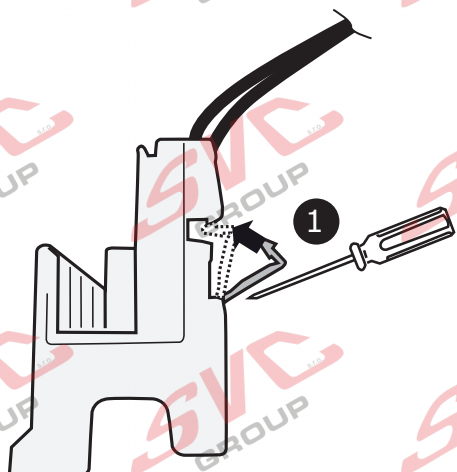

Close secondary lock!

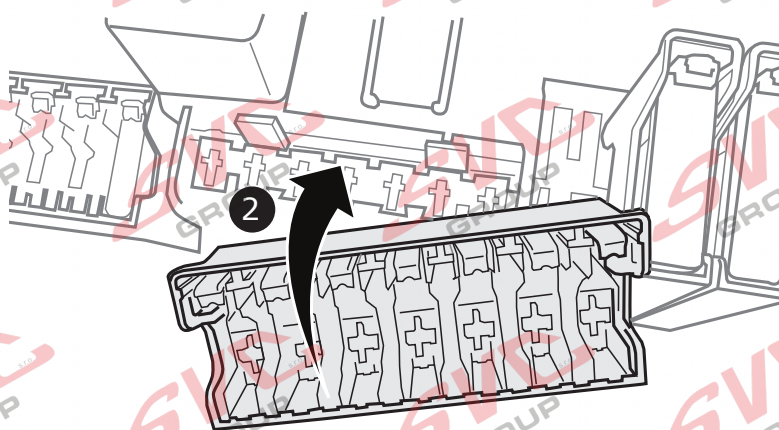

10

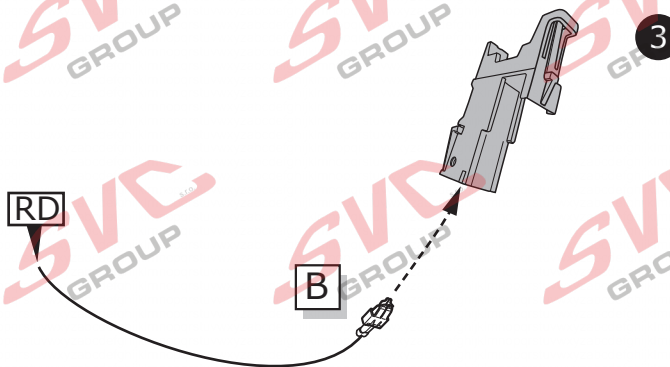
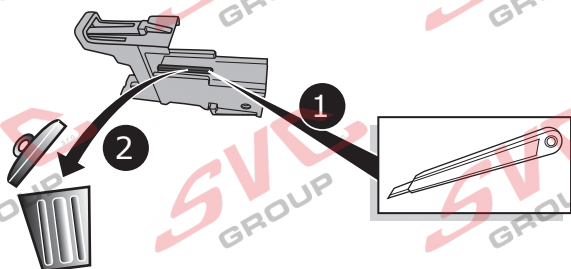

11

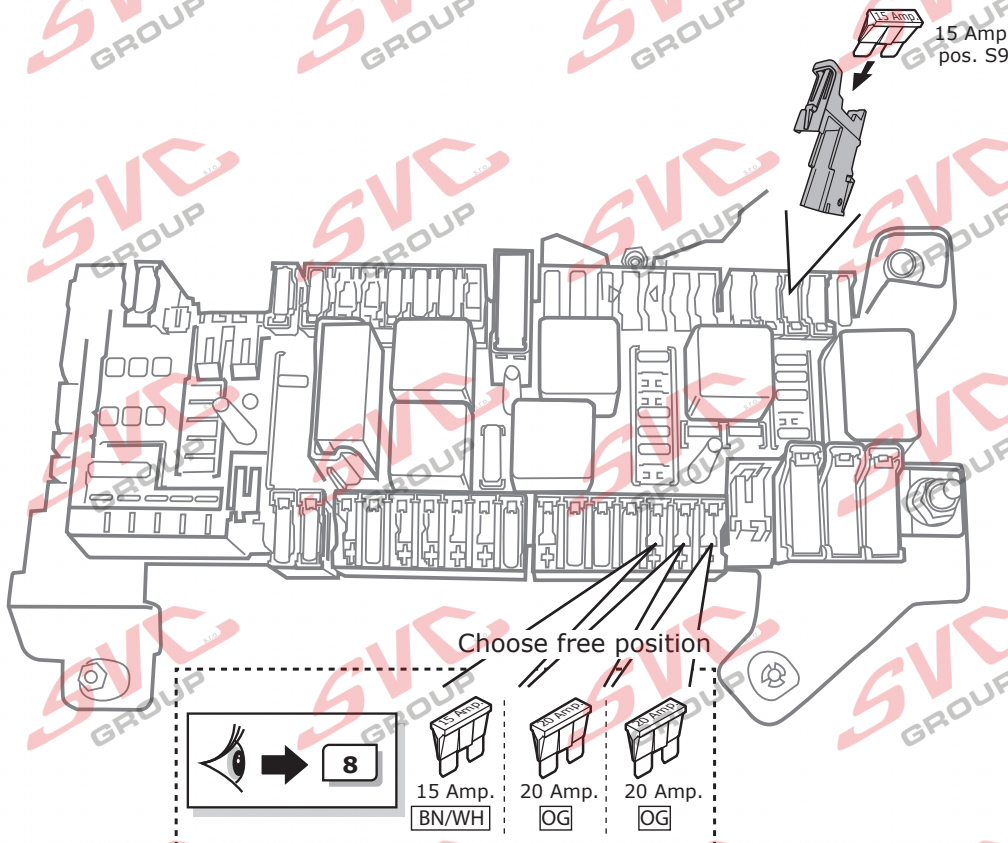

12

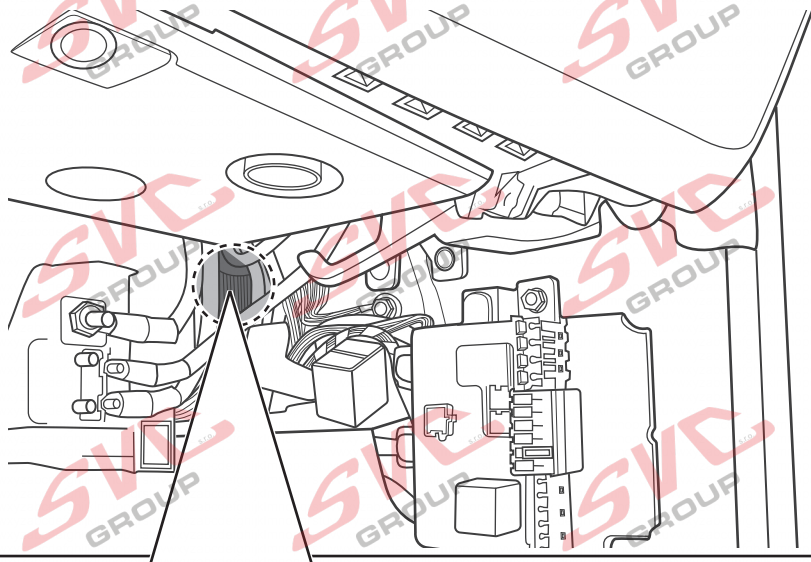
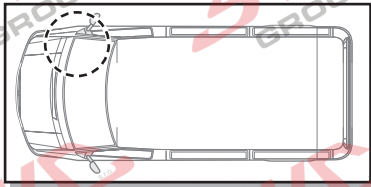

**CAN-Data Wire**

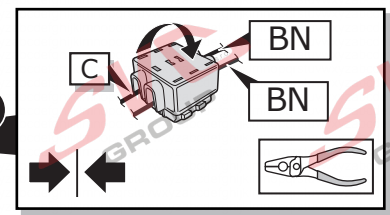
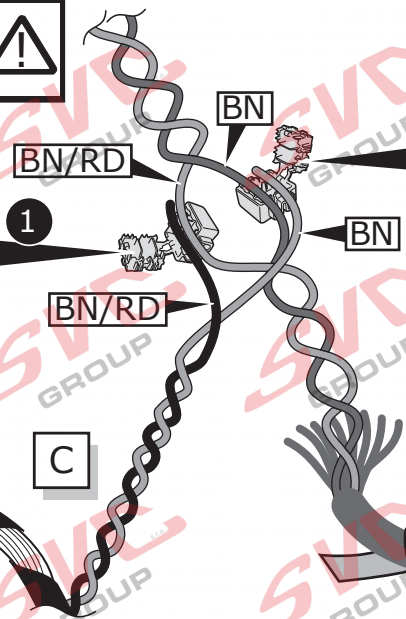
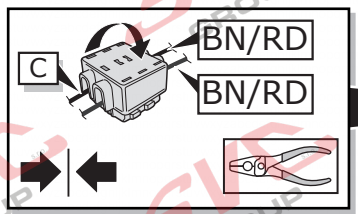
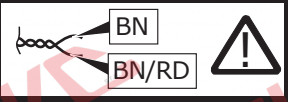

**Important!**  
Please note informations  
in picture 3!

13

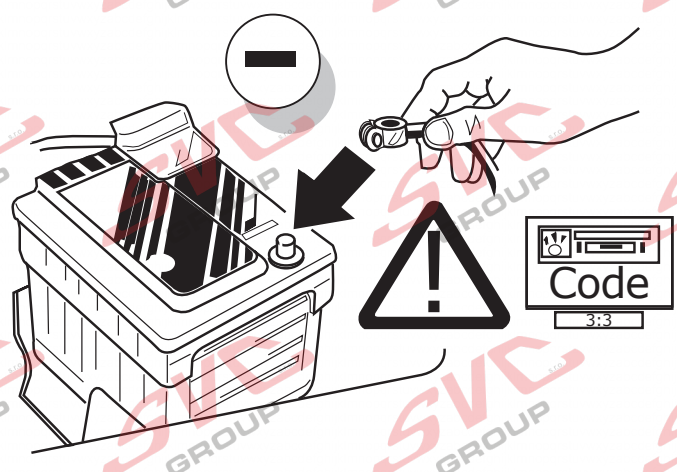



14

- (DE) Einzelteile wieder einbauen
- (FR) Remonter les pièces démontées
- (NL) Terug plaatsen onderdelen
- (GB) Reinstall linings
- (ES) Reinstalar componentes
- (IT) Rimetti a posto componenti
- (SE) Sätt tillbaka delar
- (CZ) Znovu zasuňte obložení
- (DK) Påsæt beklædningen
- (FI) Asenna verhoilut takaisin
- (GR) Τοποθετήστε ξανά τις επενδύσεις
- (NO) Sett tilbake deler
- (PL) Założyć wykładzinę

15

- (DE) Gebrauchsanleitung
- (FR) Mode d'emploi
- (NL) Gebruikershandleiding
- (GB) User guide
- (ES) Guía del usuario
- (IT) Manuale di istruzioni
- (SE) Bruksanvisning
- (CZ) Uživatelská příručka
- (DK) Brugervejledning
- (FI) Käyttöohjeet
- (GR) Οδηγός χρήστη
- (NO) Brukerveiledning
- (PL) Instrukcja obsługi

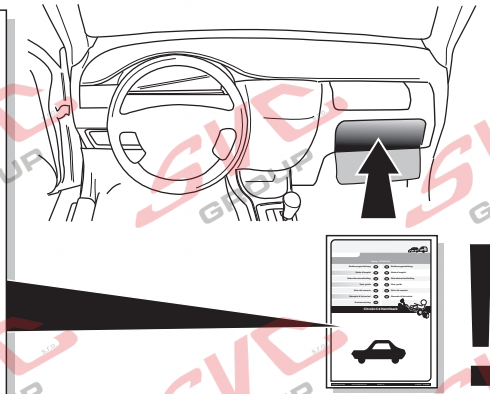

INFO

**TECHNICAL SUPPORT**

**CALL FREE**  
00800  
2255  
2327

**ECS**  
ELECTRONICS

MONDAY TO FRIDAY  
09:00 - 12:00  
13:00 - 17:00  
ts@ecs-electronics.nl  
www.ecs-electronics.nl

## Products & Service

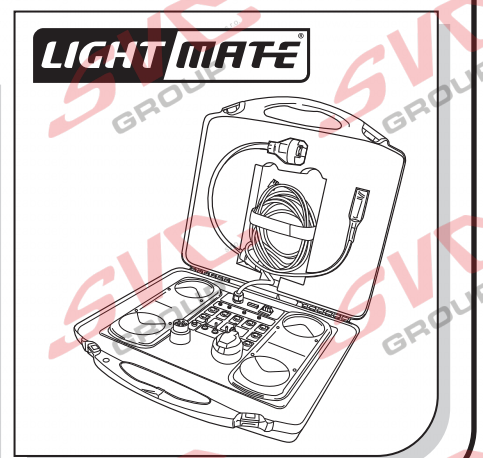
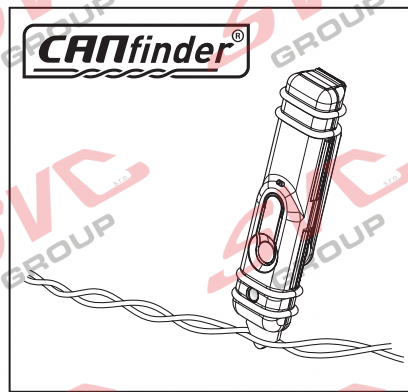

Nevíte si rady? Potřebujete poradit?

# Náš zákaznický servis je vám k dispozici

 +420 491 421 021

 [svc@svcgroup.cz](mailto:svc@svcgroup.cz)



Opravdový specialista a Certifikovaný výrobce tažných zařízení s největším sortimentem v ČR. Rodinná firma s více jak 30letou ověřenou tradicí výroby, prodeje a montáže.

[www.svcgroup.cz](http://www.svcgroup.cz)