

Montážní návod

(Montážny návod, Fitting instruction, Montageanleitung,
Istruzioni di montaggio, Monteringshandledning,
Asennusohje, Instruction de montage,
Montegehandleiding, Инструкция по установке)



Elektropřípojka Volvo V70 01/2000->06/2004

Elektropřípojka
Wiring kit
Trekhaakkabelset
E-satz
Faisceau D'attelage
Barra de remolque
Wiązka elektryczna
Vetokoukun vaijerisarja
Гачковий джгут



výrobce / dodavatel
SVC Group s.r.o.

Odkaz na produkt:

<https://www.svcgroup.cz/tazne-zarizeni-sro-uby-pevny-skoda-rapid-monte-carlo-10-2012-2018-p7283-v960>















www.svcgroup.cz

MONTAGE-HANDLEIDING ELEKTROSET VOOR TREKHAAK MET 13-POLIGE CONTACT-DOOS VLGS. DIN/ISO NORM 11446

VOLVO S80 1998-
VOLVO V70 2000- + VOLVO S60 2000-
VOLVO XC 90 2003-

Bestel Nr.: VL-001-DQ

1. Klap de helft van de vloerplaat naar achteren.
Verwijder de beugel en de kunststof bak van de accu.
Verwijder de negatieve klem van de accu.
Verwijder het linker en rechter zijpaneel.
Verwijder de achterdorpel.
2. Maak gebruik van de tule die zich in de bodem van de kofferruimte, rechts naast de accu, bevindt.
Knip het kapje op de tule af.
3. De kabelboom wordt in de kofferruimte uitgelegd.
Leid het 13-polige uiteinde door de tule naar de contactdoos.
Schuif de rubber afdekplaat over de kabelboom.
Neem vervolgens de contacthouder uit de contactdoos en sluit de draden als volgt aan:

DIN/ISO 11446	(D)	(F)	(GB)	(NL)	
	1/L	gelb	jaune	yellow	geel
	2	blau	bleu	blue	blauw
 1-8	3/31	weiß	blanc	white	wit
	4/R	grün	vert	green	groen
	5/58-R	braun	marron	brown	bruin
	6/54	rot	rouge	red	rood
	7/58-L	schwarz	noir	black	zwart
 Reverse	8	schwarz/rot	noir/rouge	black/red	zwart/rood
 30+	9	braun/weiß	marron/blanc	brown/white	bruin/wit
 15+	10	rot	rouge	red	rood
 10	11	weiß	blanc	white	wit
 12	12	rot/blau	rouge/bleu	red/blue	rood/blauw
 9	13	weiß	blanc	white	wit

Monteer de contactdoos op de trekhaak.

4. Aan de linkerzijde (S80 & S60), het midden (V70), of aan de rechterzijde (XC 90) in de kofferruimte bevindt zich een voorbereide stekker.
Sluit de 13-polige connector van de kabelboom hierop aan.
Bevestig het oogje met de witte draden op de negatieve pool van de accu.

5. Aan de linkerkant in de kofferruimte bevindt zich de zekeringkast. Plaats het meegeleverde relais in de vrije positie A zoals aangegeven in de afbeelding. Indien u ook mistlichtuitschakeling wenst, kunt u contact opnemen met de dealer. Deze kan voor u de benodigde gegevens downloaden.
6. Plaats de meegeleverde 15 amp. zekering (+30) in positie 9 in de zekeringkast (B). Dit hoeft alleen wanneer in deze positie nog geen zekering geplaatst is.
7. De 3-polige connector met de rode en rood/blauwe draad is voor uitbreiding van de contactdoosfuncties.
8. Sluit de negatieve klem aan op de accu. Controleer de elektrische functies met de aanhanger aangesloten. Monteer alle gedemonteerde onderdelen.

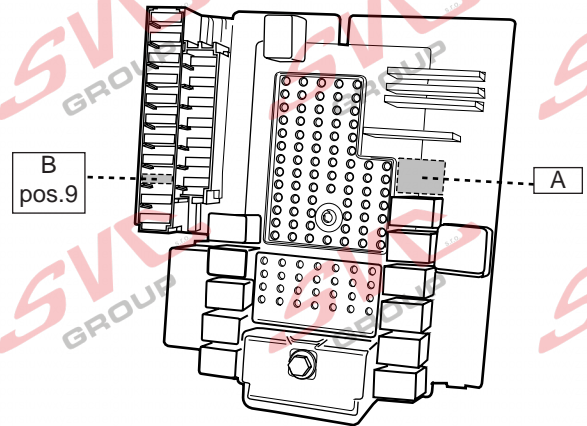













EINBAUANLEITUNG ELEKTROSATZ ANHÄNGERVORRICHTUNG MIT 13-P STECKDOSE lt. DIN/ISO NORM 11446

VOLVO S80 1998-
VOLVO V70 2000- + VOLVO S60 2000-
VOLVO XC 90 2003-

Bestell Nr.: VL-001-DQ

- Die Hälfte der Bodenplatte nach hinten verlegen.
Den Bügel und den kunststoff Behälter der Batterie entfernen.
Das Minuskabel der Batterie entfernen.
Die linke und rechte Panele entfernen.
Die Schwelle an der Rückseite entfernen.
- Die Tülle, die sich im Boden des Gepäckraums an der rechten Seite der Batterie befindet, verwenden.
Die Kappe der Tülle abschneiden.
- Der Kabelsatz wird im Gepäckraum ausgebreitet.
Das 13-polige Ende durch die Tülle zur Steckdose führen.
Die Abdeckplatte über den Kabelsatz schieben.
Den Kontaktträger aus der Steckdose entfernen und die Kabel wie folgt anschließen:

DIN/ISO 11446		(D)	(F)	(GB)	(NL)
	1/L	gelb	jaune	yellow	geel
	2	blau	bleu	blue	blauw
 1-8	3/31	weiß	blanc	white	wit
	4/R	grün	vert	green	groen
	5/58-R	braun	marron	brown	bruin
	6/54	rot	rouge	red	rood
	7/58-L	schwarz	noir	black	zwart
 Reverse	8	schwarz/rot	noir/rouge	black/red	zwart/rood
 30+	9	braun/weiß	marron/blanc	brown/white	bruin/wit
 15+	10	rot	rouge	red	rood
 10	11	weiß	blanc	white	wit
	12	rot/blau	rouge/bleu	red/blue	rood/blauw
 9	13	weiß	blanc	white	wit

Die Steckdose auf die Steckdoseplatte montieren.

- An der linken Seite (S80 & S60), in der Mitte (V70), oder an der rechten Seite (XC 90) im Gepäckraum befindet sich ein vorbereiteter Stecker.
Den 13-poligen Steckverbinder des Kabelsatzes daran anschließen.
Das Auge mit den weißen Kabeln auf den - Pol der Batterie anschließen.

5. An der linken Seite im Gepäckraum befindet sich der Sicherungskasten. Das beiliegende Relais in der freien Position A wie in der Abbildung angegeben, befestigen. Falls Sie auch Nebelschlußleuchte Ausschaltung haben möchten, so können Sie mit Ihrem Händler in Kontakt treten. Er kann die benötigten Informationen downloaden.

6. Die beiliegende 15 amp. Sicherung (+30) in der Position 9 in dem Sicherungskasten (B) befestigen. Dieses ist nur notwendig, wenn in dieser Position noch keine Sicherung vorhanden ist.

7. Den 3-poligen Steckverbinder mit dem roten und rot/blauen Kabel ist für Erweiterung der Steckdosefunktionen vorgesehen.

8. Die Batterie wieder anschließen und sämtliche Fahrzeugfunktionen mit angeschlossenem Anhänger überprüfen. Die abmontierten und entfernten Teile wieder montieren.

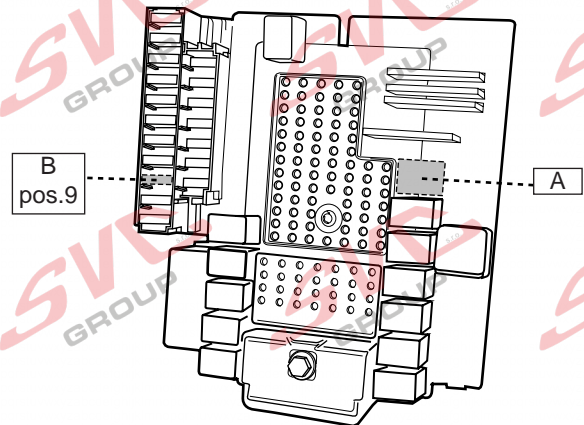













FITTING INSTRUCTIONS ELECTRIC WIRINGKIT TOWBAR WITH 13-P SOCKET UP TO DIN/ISO NORM 11446

VOLVO S80 1998-
VOLVO V70 2000- + VOLVO S60 2000-
VOLVO XC 90 2003-

Partno.: VL-001-DO

1. Pull half of the floor cover backwards.
Remove the clamp and the plastic box of the battery.
Remove the battery earth cable.
Remove the left and right side panel.
Remove the rear sill plate.
2. Use the grommet which is located in the bottom of the boot, at the right-hand side of the battery.
Cut the cap of the grommet.
3. Route the wiring harness in the boot.
Lead the 13-pole end through the grommet to the socket.
Pull the rubber coverplate over the wiring harness.

DIN/ISO 11446		(D)	(F)	(GB)	(NL)
	1/L	gelb	jaune	yellow	geel
	2	blau	bleu	blue	blauw
 1-8	3/31	weiß	blanc	white	wit
	4/R	grün	vert	green	groen
	5/58-R	braun	marron	brown	bruin
	6/54	rot	rouge	red	rood
	7/58-L	schwarz	noir	black	zwart
 Reverse	8	schwarz/rot	noir/rouge	black/red	zwart/rood
 30+	9	braun/weiß	marron/blanc	brown/white	bruin/wit
 15+	10	rot	rouge	red	rood
 10	11	weiß	blanc	white	wit
	12	rot/blau	rouge/bleu	red/blue	rood/blauw
 9	13	weiß	blanc	white	wit

Remove the contactholder from the socket and fit the wires as indicated below:

Mount the socket to the towbar.

4. At the left-hand side (S80 & S60), the middle (V70), or at the right-hand side (XC 90) of the boot a prepared connector is located.
Connect the 13-pole connector of the wiring harness with this connector.
Fit the ringtongue with the white wires at the negative pole of the battery.

5. At the left-hand side in the boot the fuse box is located.
Fit the supplied relay in the free position A as indicated in the picture.
If you want to have rearfoglight disconnection, you should contact your dealer. He can download the information you need.
6. Fit the supplied 15 amp. fuse (+30) in position 9 of the fuse box (B).
This is only necessary if there isn't a fuse located yet.
7. The 3-pole connector with the red and red/blue wire is for extending the socket functions.
8. Reconnect the battery and check all electric functions, with trailer/cara-van connected.
Reinstall disassembled parts.

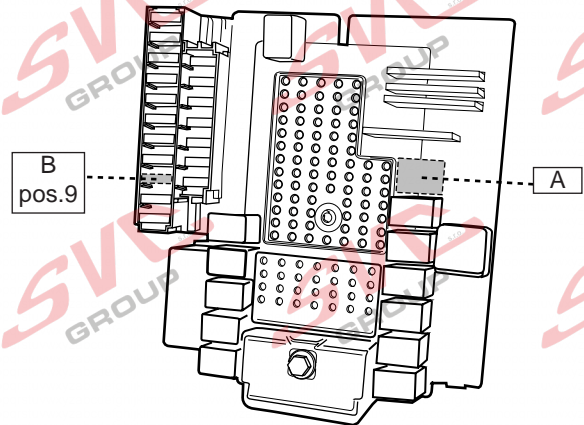













INSTRUCTION DE MONTAGE DU FAISCEAU ELECTRIQUE POUR CROCHET D'ATTELAGE
CONFORME A LA NORME DIN/ISO 11446 PRISE 13-P

VOLVO S80 1998-
VOLVO V70 2000- + VOLVO S60 2000-
VOLVO XC 90 2003-

Reference: VL-001-DQ

- Placez la moitié du tapis arrière.
Enlevez l'armature et la boîte plastique de la batterie.
Débranchez la cosse négative de la batterie.
Enlevez les panneaux sur le côté gauche et droit.
Enlevez le seuil.
- Utilisez le passe-fils qui se trouve au fond du coffre, sur le côté droit de la batterie.
Coupez le chaperon du passe-fils.
- Placez le jeu de câbles dans le coffre.
Menez la terminaison 13-pôles du faisceau électrique via le passe-fils jusqu'à la prise.
Poussez la gaine protectrice sur le faisceau.
Faites sortir les fiches de contact de la prise et connectez les fils comme indiqué ci-dessous:

DIN/ISO 11446	(D)	(F)	(GB)	(NL)
 1/L	gelb	jaune	yellow	geel
 2	blau	bleu	blue	blauw
 1-8	weiß	blanc	white	wit
 4/R	grün	vert	green	groen
 5/58-R	braun	marron	brown	bruin
 6/54	rot	rouge	red	rood
 7/58-L	schwarz	noir	black	zwart
 Reverse 8	schwarz/rot	noir/rouge	black/red	zwart/rood
 30+ 9	braun/weiß	marron/blanc	brown/white	bruin/wit
 15+ 10	rot	rouge	red	rood
 10 11	weiß	blanc	white	wit
 12	rot/blau	rouge/bleu	red/blue	rood/blauw
 9 13	weiß	blanc	white	wit

Montez la prise sur le crochet d'attelage.

- Sur le côté gauche (S80 & S60), au milieu (S70) ou à droite le côté (XC 90) le du coffre se trouve un connecteur préparé.
Connectez-y le connecteur 13-pôles du faisceau électrique.
Branchez la cosse avec les fils blancs à la pôle négative de la batterie.

5. Sur le côté gauche du coffre se trouve la boîte fusible.
Placez le relais livré dans la position libre A, comme indiqué dans l'illustration.
Quand vous voulez disconnection des feux de brouillard, vous pouvez aller à votre concessionnaire dépositaire. Il peut downloaden l'information que vous devez avoir.
6. Placez le fusible 15 amp. (+30) dans la position 9 de la boîte fusible (B).
C'est seulement nécessaire quand il n'y a pas une fusible dans cette position.
7. Le connecteur 3-pôles avec le fil rouge et rouge/bleu est pour enlarger les fonctions de la prise.
8. Rebranchez la cosse négative de la batterie.
Contrôlez les fonctions électrique chez la remorque accouplée.
Remontez les parts enlevés.

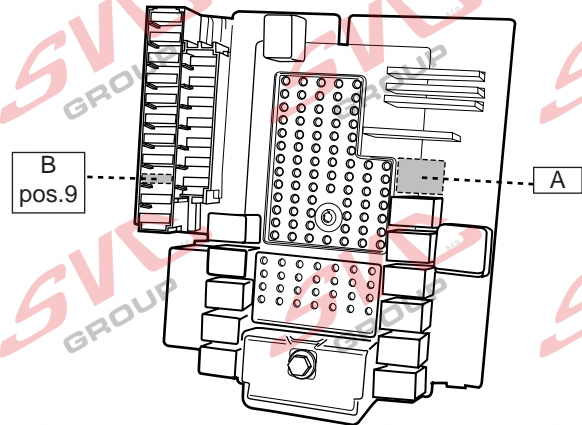

Nevíte si rady? Potřebujete poradit?

Náš zákaznický servis je vám k dispozici

 +420 491 421 021

 svc@svcgroup.cz



Opravdový specialista a Certifikovaný výrobce tažných zařízení s největším sortimentem v ČR. Rodinná firma s více jak 30letou ověřenou tradicí výroby, prodeje a montáže.

www.svcgroup.cz