

# Montážní návod

(Montážny návod, Fitting instruction, Montageanleitung,  
Istruzioni di montaggio, Monteringshandledning,  
Asennusohje, Instruction de montage,  
Montegehandleiding, Инструкция по установке)



## Elektropřípojka Dacia Jogger 03/2022->

Elektropřípojka  
Wiring kit  
Trekhaakkabelset  
E-satz  
Faisceau D'attelage  
Barra de remolque  
Wiązka elektryczna  
Vetokoukun vaijerisarja  
Гачковий джгут



výrobce / dodavatel

**SVC Group s.r.o.**

Odkaz na produkt:

<https://www.svcgroup.cz/tazne-zarizeni-sro-uby-pevny-skoda-rapid-monte-carlo-10-2012-2018-p7283-v960>



[www.svcgroup.cz](http://www.svcgroup.cz)

ERICH JAEGER

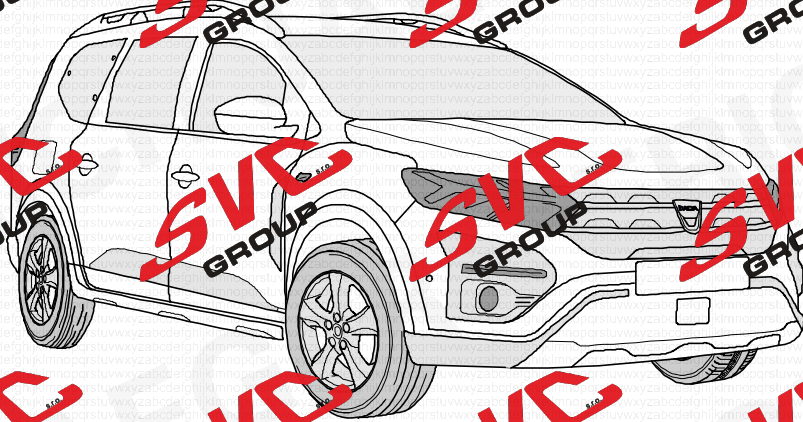
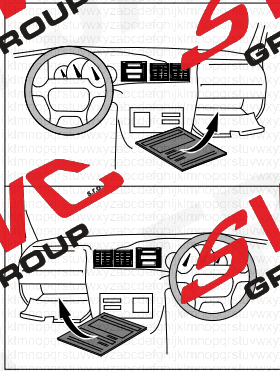
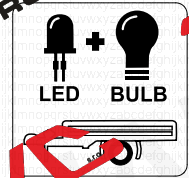

DACIA Jogger

04/22 >>

747556

Für aktuellste Version scannen  
Scan for current version

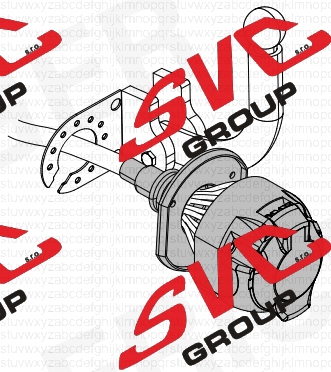

ISO 1446



- (D) Einbauanleitung
- (GB) Installation instructions
- (C) Consignes de montage
- (NL) Montagehandleiding
- (DK) Montagevejledning
- (N) Monteringsinstruksjon
- (S) Installationsanvisning
- (FI) Asennusohje
- (I) Istruzioni per il montaggio
- (E) Instrucciones de montaje
- (P) Instruções de montagem
- (GR) Οδηγίες εγκατάστασης
- (CZ) Návod k montáži

- (PL) Instrukcja montażu
- (TR) Montaj talimatı
- (H) Szerelési útmutató
- (HR) Upute o ugradnji
- (B) Инструкција за монтаж
- (RO) Instrucțiuni de montaj
- (RU) Инструкция по монтажу и установке
- (LT) Montavimo informacija
- (LV) Ieinstalācijas pamācība
- (EST) Paigaldusjuhend
- (SLO) Navodilo za vgradnjo
- (SK) Montážny návod





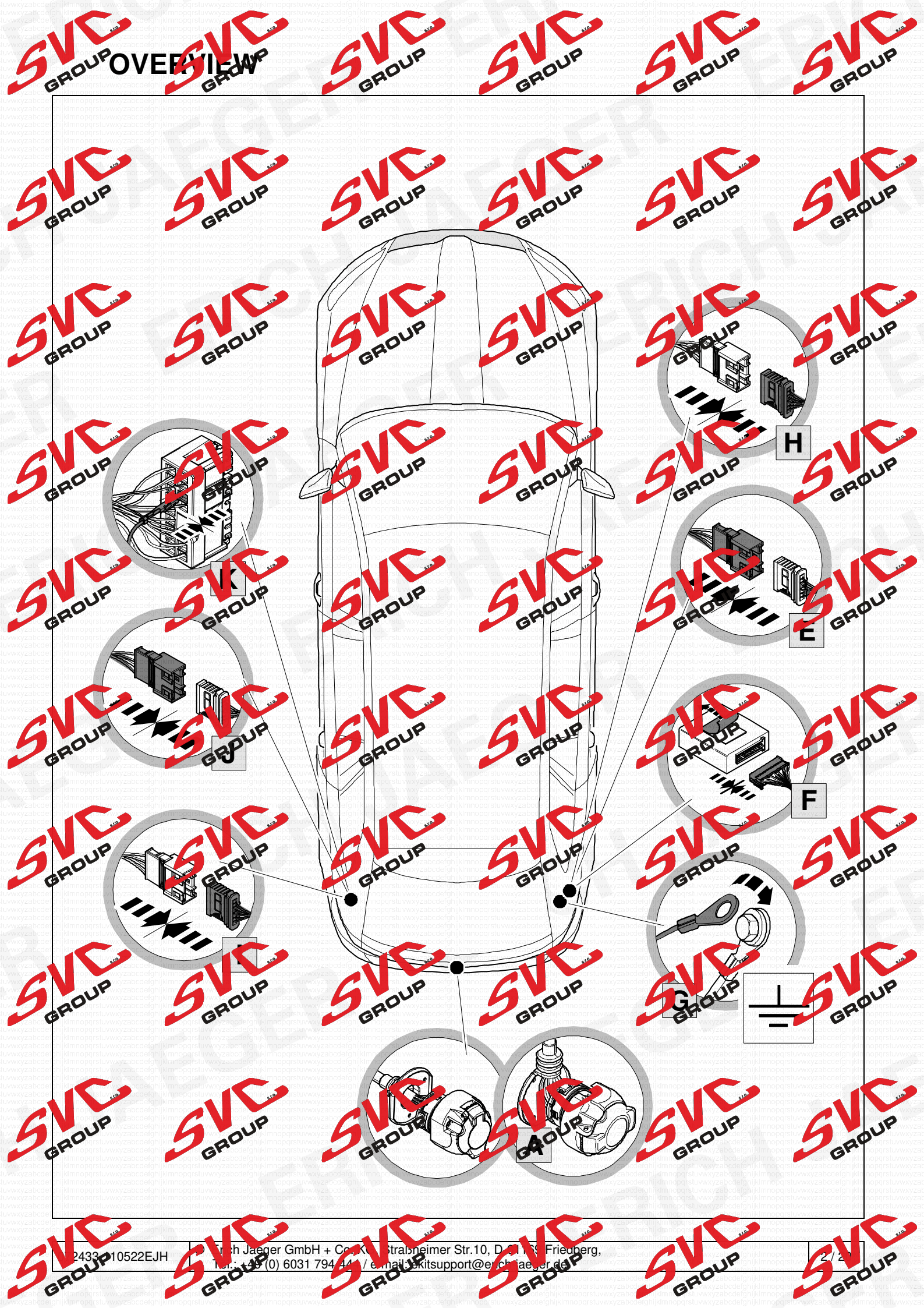

OVERVIEW

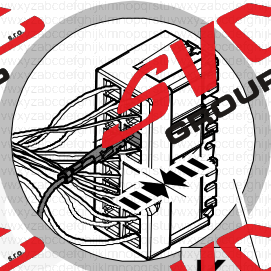

H



E

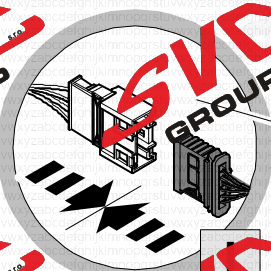

F

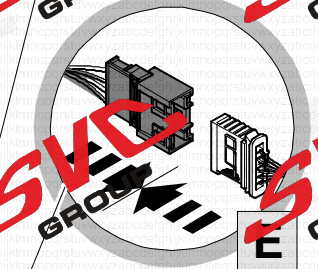

E

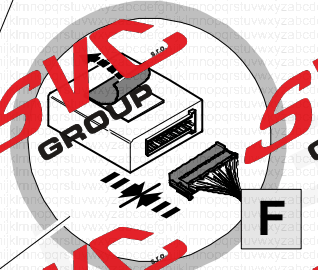

F

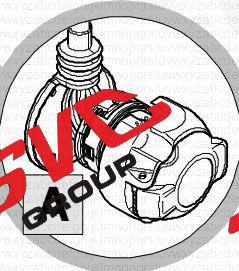
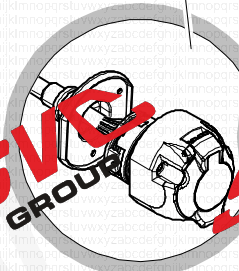
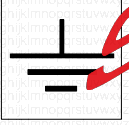
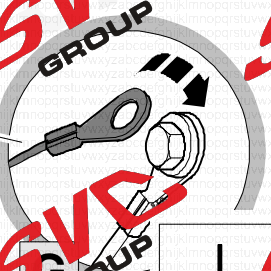

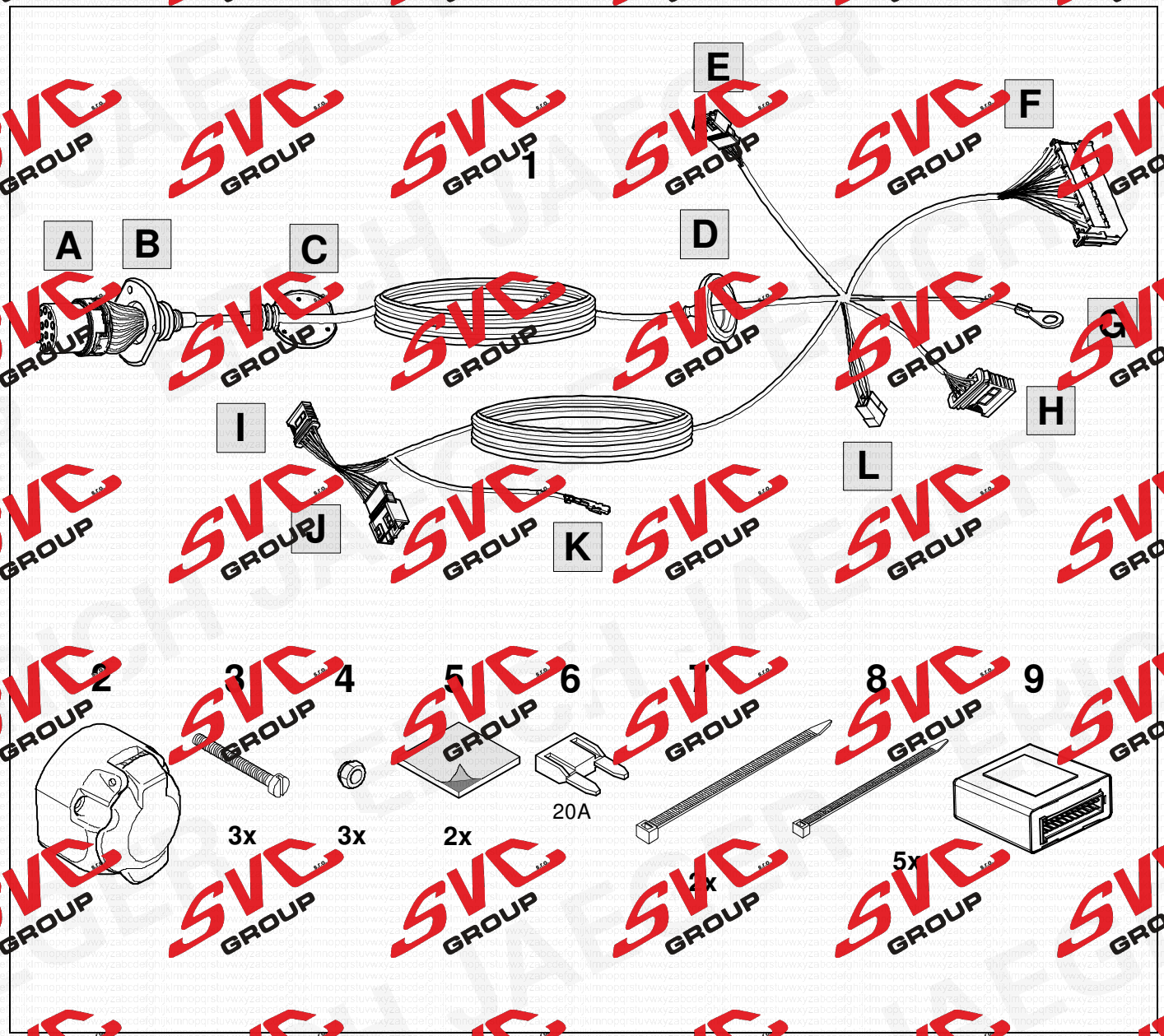

SVC GROUP TOOLS SVC GROUP SVC GROUP SVC GROUP SVC GROUP

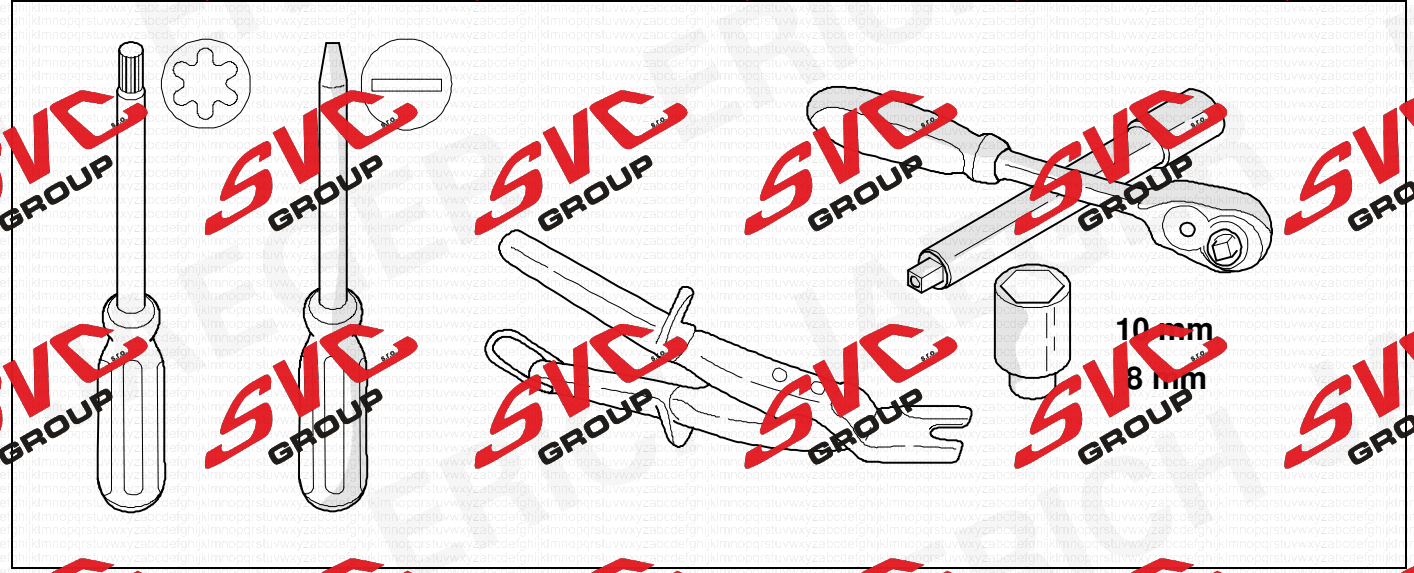



**OPTION 1**

**OPTION 2**

[www.erich-jaeger.com](http://www.erich-jaeger.com)

- Service & Support
- Coding
- FAQ

WWW

1

GROUP 7.

10 m

3.

+

-

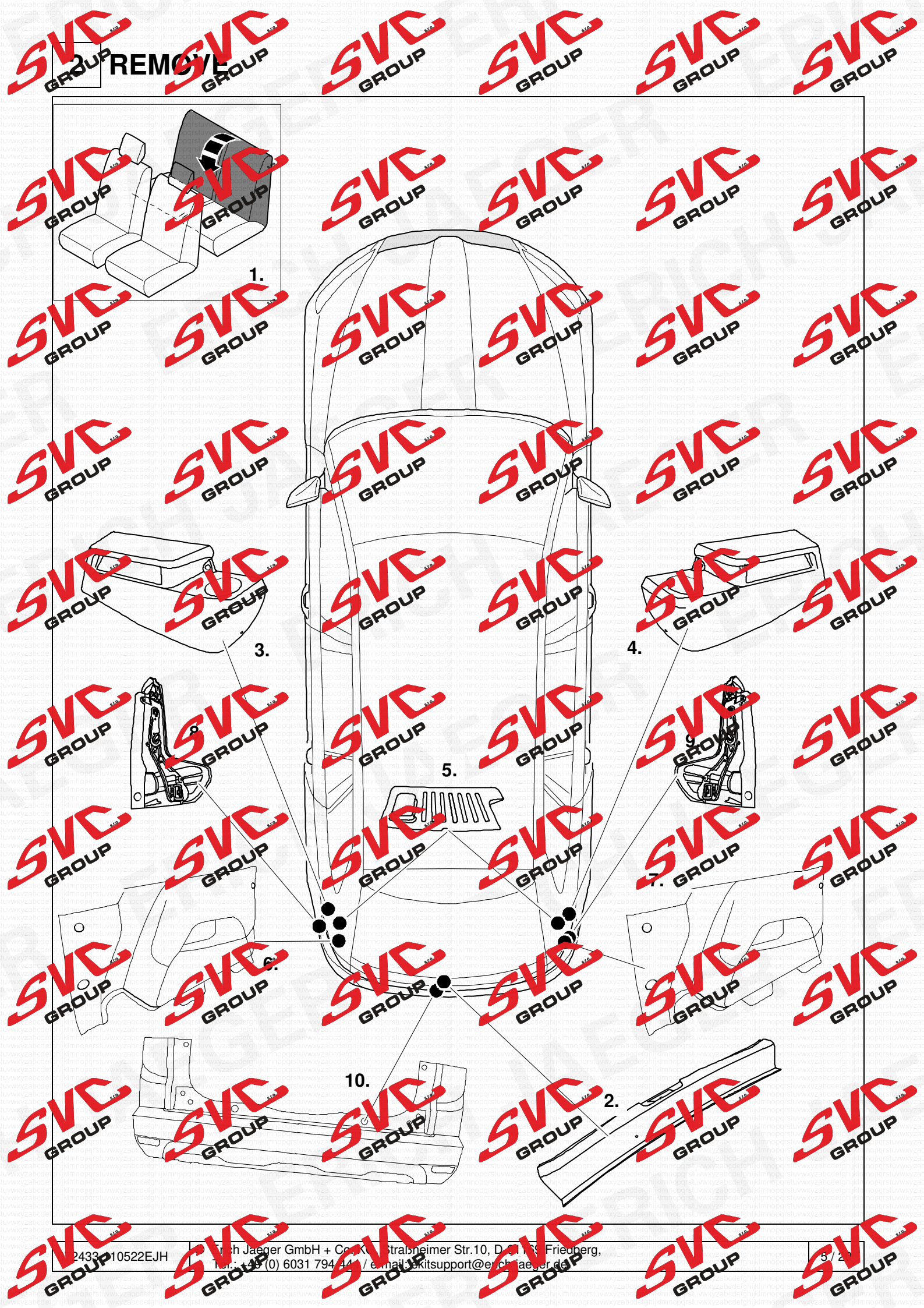

REMOVAL



SVC GROUP SVC GROUP SVC GROUP SVC GROUP SVC GROUP SVC GROUP

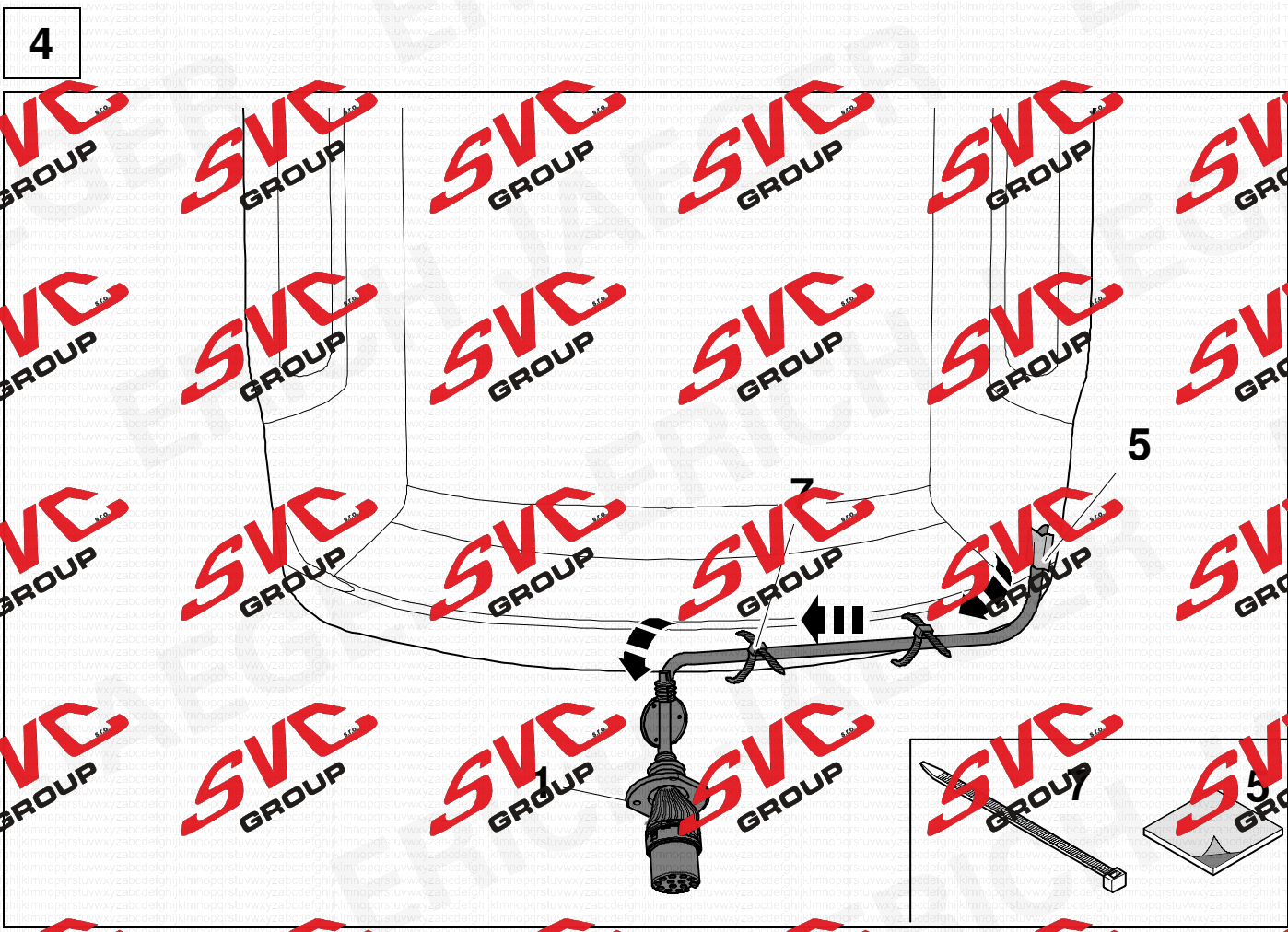
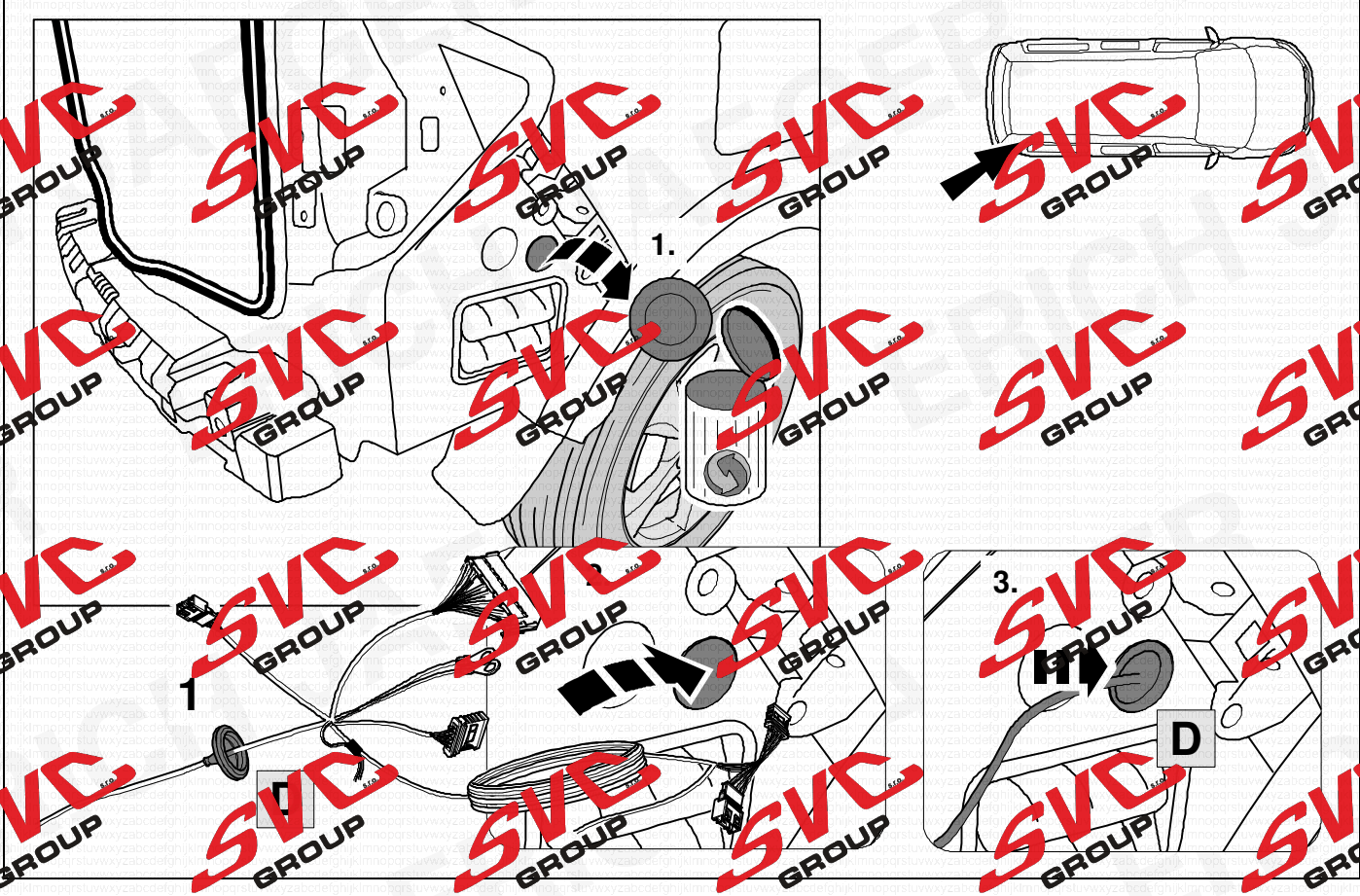

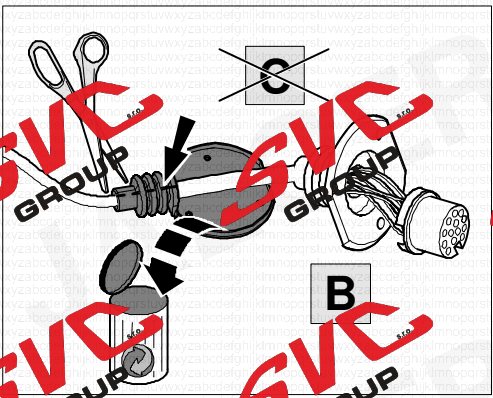
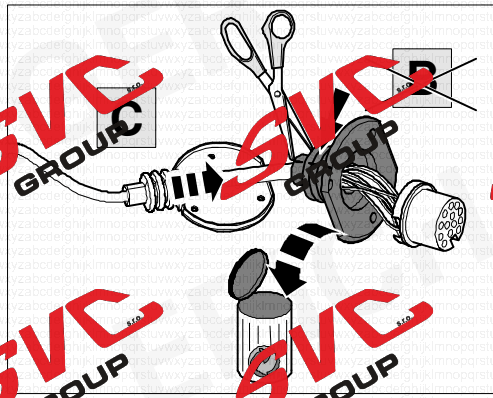
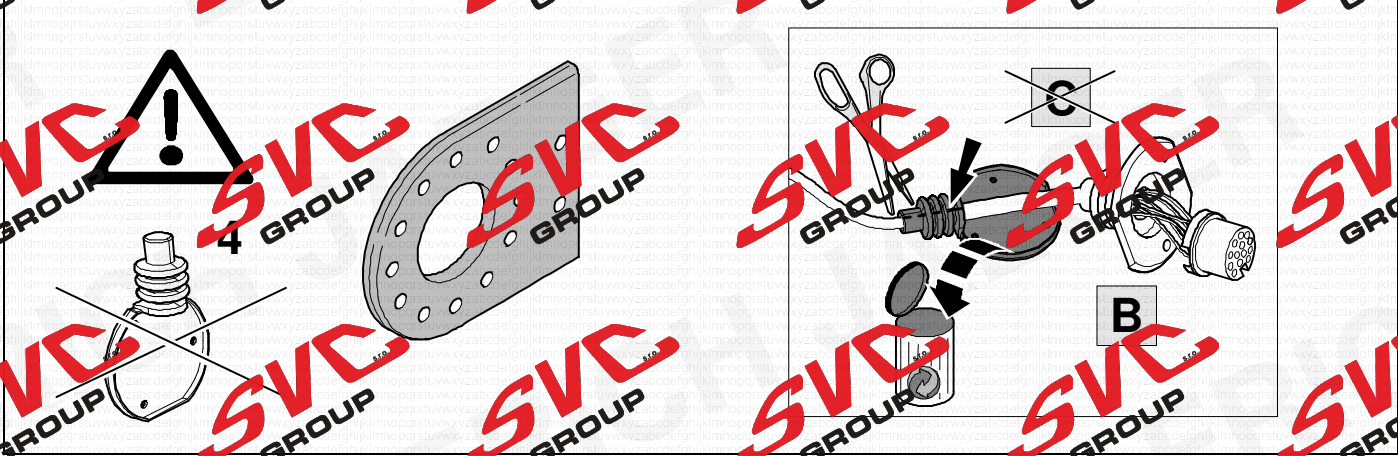
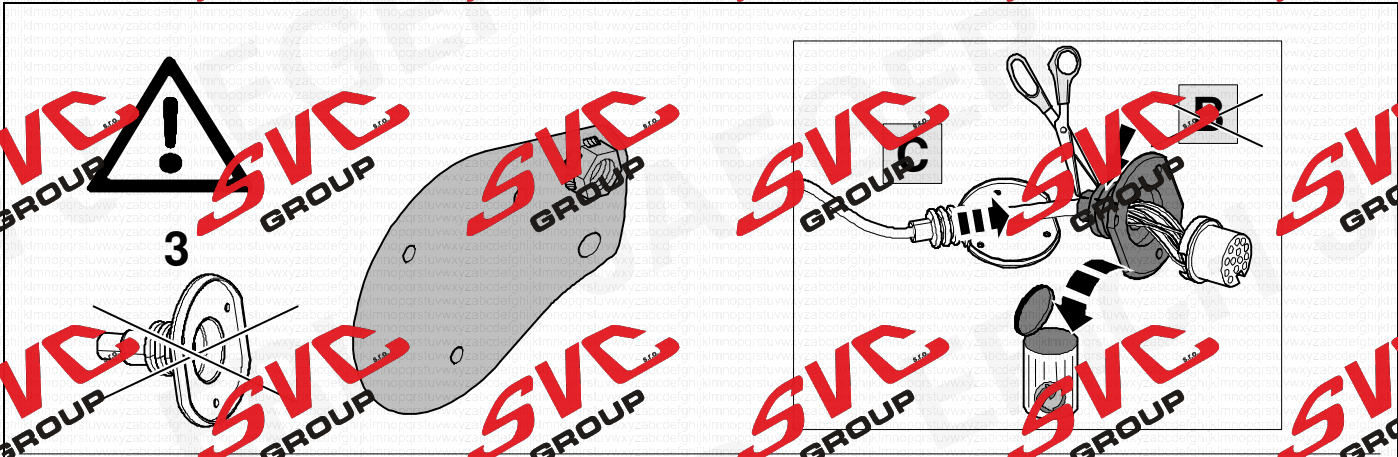
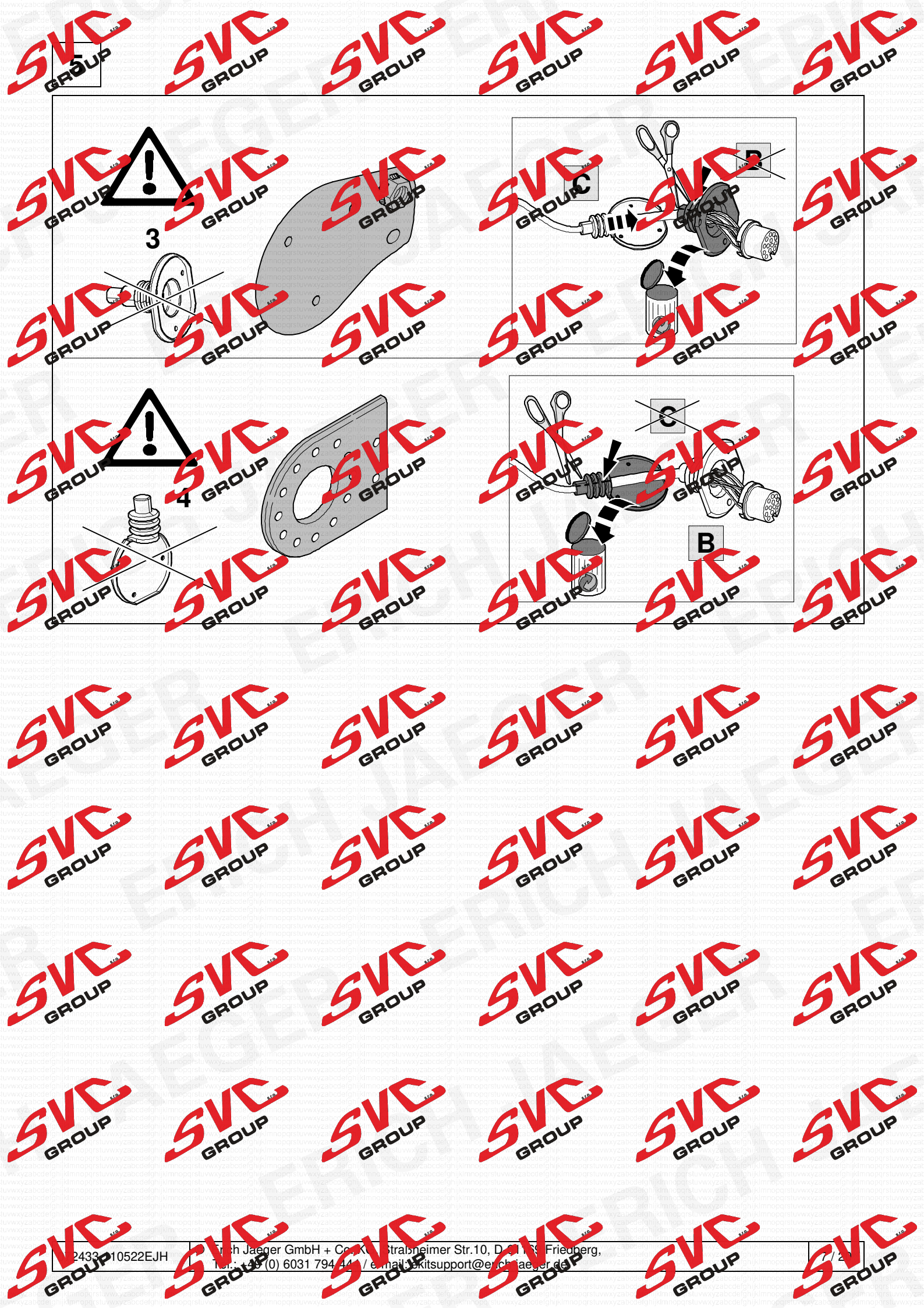



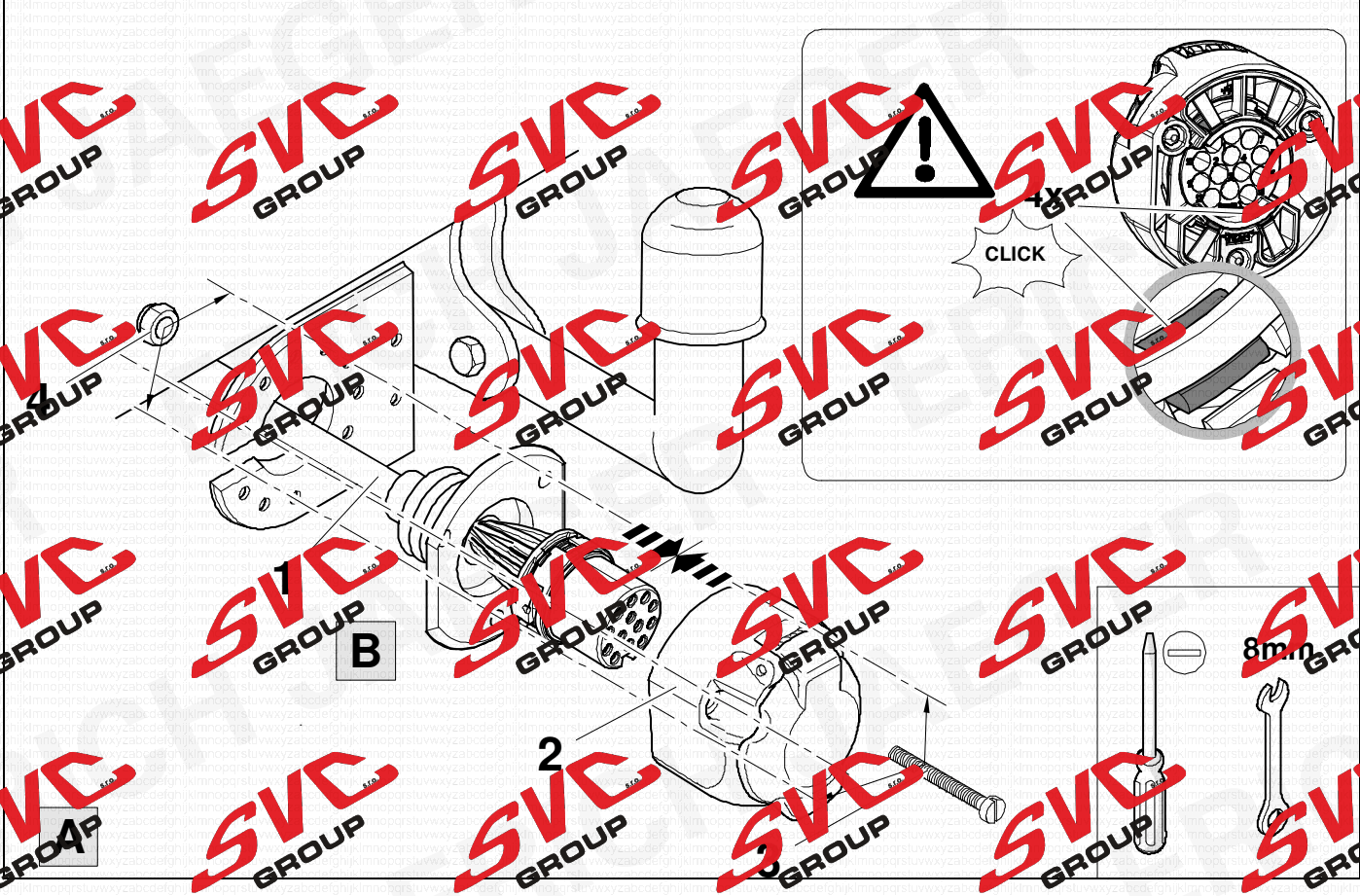

7 → 8

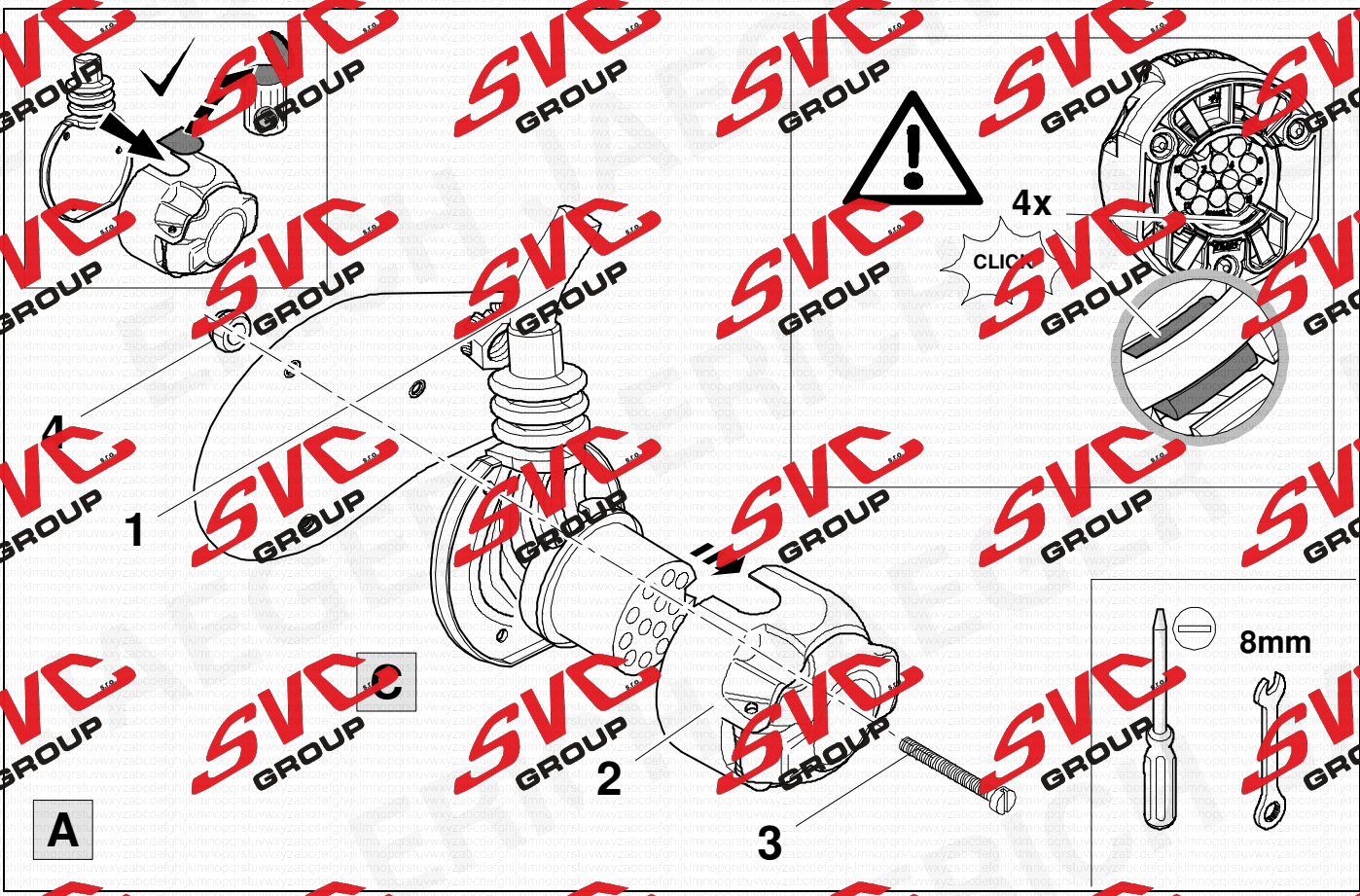

1	bk/wh		8	bu/rd	
2	gy wh/bn		9	rd/bu	
3	wh/bn		10	ye	
4	bk/gn		11	bn/gn	
5	gy/rd		12	no	
6	bk/rd		13	bn	
7	gy/bk				

	bk	wh	gy	gn	rd	bu	ye	bn	br	or	no
(D)	schwarz	weiß	grau	grün	rot	blau	gelb	braun	violett	orange	nicht belegt
(GB)	black	white	grey	green	red	blue	yellow	brown	purple	orange	not occupied
(F)	noir	blanc	gris	vert	rouge	bleu	jaune	brun	violet	orange	inutilisé
(NL)	zwart	wit	grijs	groen	rood	blauw	geel	bruin	violet	oranje	niet aangevonden
(DK)	sort	hvid	grå	grøn	rød	blå	gul	brun	violett	orange	ikke anvendt
(N)	svart	hvit	grå	grønn	rød	blå	gul	brun	fiolett	oransje	ikke i bruk
(S)	svart	vit	grå	grön	röd	blå	gul	brun	violett	orange	ej använd
(IN)	musta	valkoinen	harmaa	vihreä	punainen	sininen	keltainen	ruskea	violett	oranssi	ei varattu
	nero	bianco	grigio	verde	rosso	blu	giallo	marrone	violetto	arancione	non libero
(E)	negro	blanco	gris	verde	rojo	azul	amarillo	marrón	violeta	anaranja-do	no ocupado
(P)	preto	branco	cinzento	verde	vermelho	azul	amarelo	castanho	violeta	laranja	não ocupado
(GR)	σκούρος	λευκός	γκρίζος	πράσινος	κόκκινος	μπλε	κίτρινος	καφέ	μωβ	πορτοκάλι	δεν είναι κλεισμένο
(PL)	czarny	biały	szary	zielony	czarny	niebiesko	żółty	brązowy	fioletowy	pomarańczowy	wolny
(CZ)	černý	bílý	šedý	zelený	červený	modrý	žlutý	hnědý	fialový	oranžový	neobsazen
(TR)	siyah	beyaz	gri	yeşil	kırmızı	mavi	sarı	kahverengi	mor	portakal rengi	boş
(H)	fekete	fehér	szürke	zöld	piros	kék	sárga	barna	ibolyakék	narancssárga	nem foglalt
(IR)	crno	bijel	sivo	zeleno	crveno	plavo	zuto	smeđe	ljubičast	narandasto	nije zauzeto
(RU)	черен	бел	сив	зелен	красн	син	желт	кафяв	фиолетов	оранжев	свободно
(RO)	negru	alb	gri	verde	roșu	albastru	galben	maro	violet	portocaliu	liber
(RU)	черный	белый	серый	зеленый	красный	голубой	желтый	коричневый	пурпурный	оранжевый	свободно
(LT)	juoda	balta	pilka	žalia	raudona	lylyna	geltona	ruda	purpurinė	oranžinė	laisva
(V)	melna	balta	peloka	zala	svana	plavo	zelte	bruna	purpur-sarkana	oranža	svys
(EST)	must	valge	hall	roheline	punane	sinine	kollane	pruun	purpur-vanane	oraanz	vaba
(SLO)	črna	bela	siva	zelena	rdeča	modra	rumena	smeđ	vijoličast	oranžen	ni zasedeno
(SK)	čierny	biely	šedý	zelený	červený	modrý	žltý	hnědý	fialový	pomarančový	neobsadený



SVC GROUP

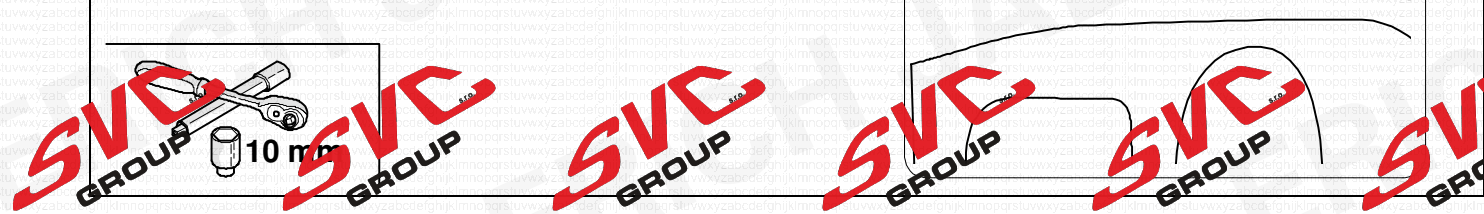
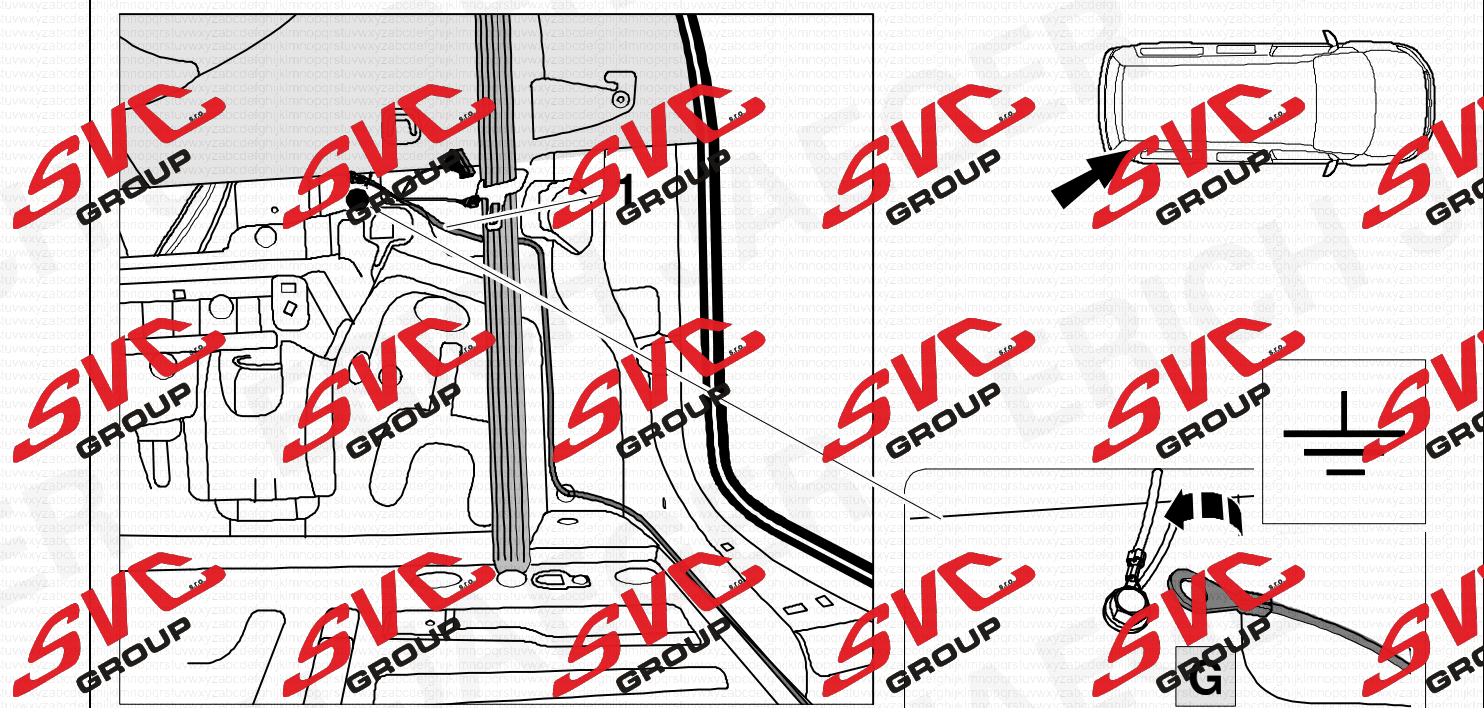

11

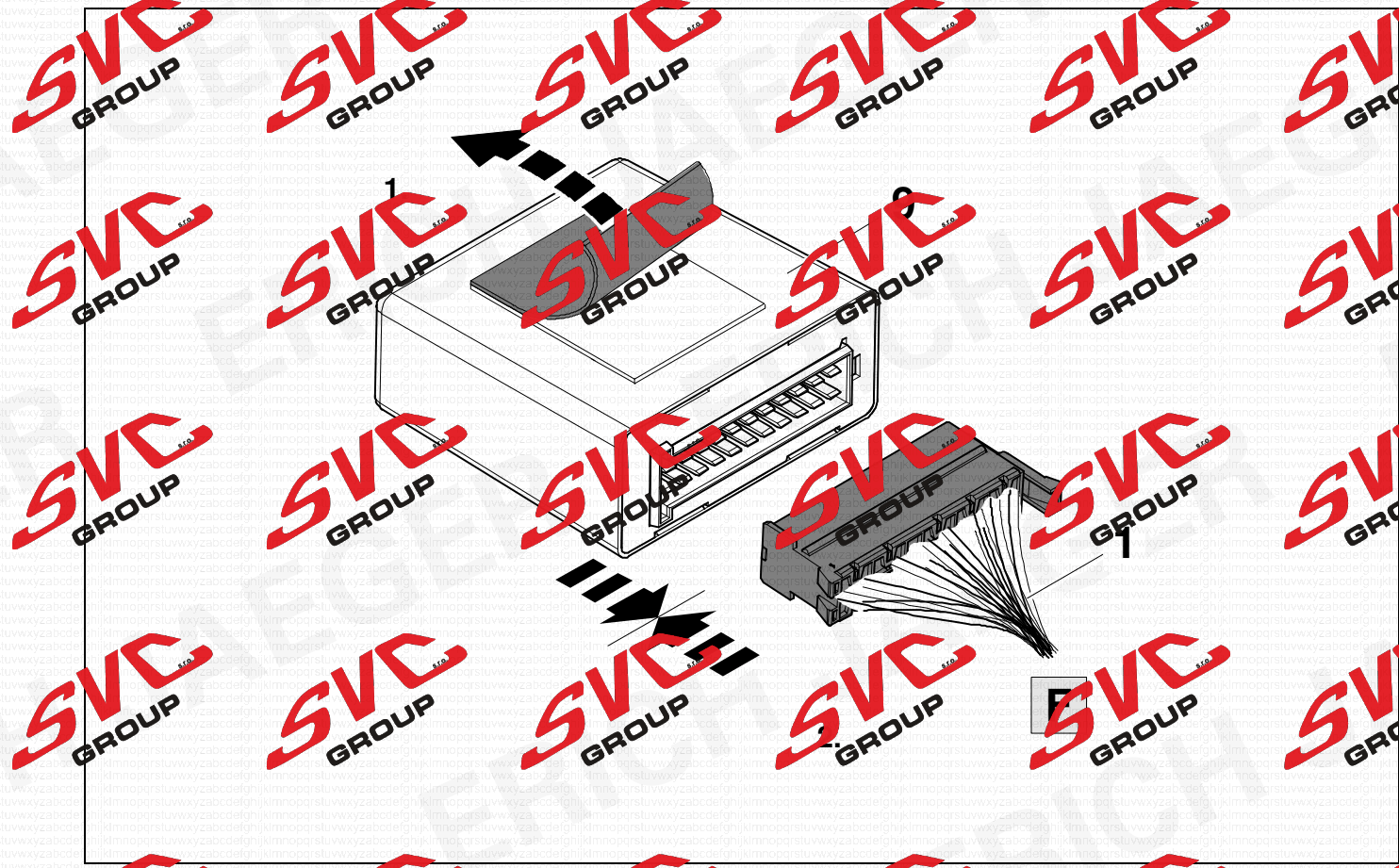

SVC GROUP SVC GROUP SVC GROUP SVC GROUP SVC GROUP SVC GROUP

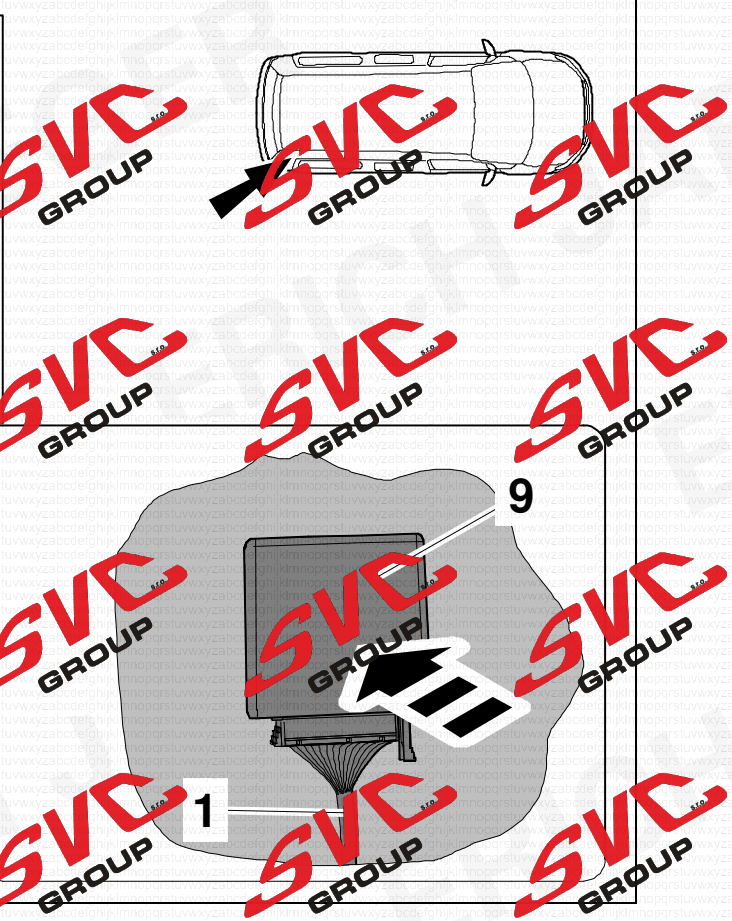
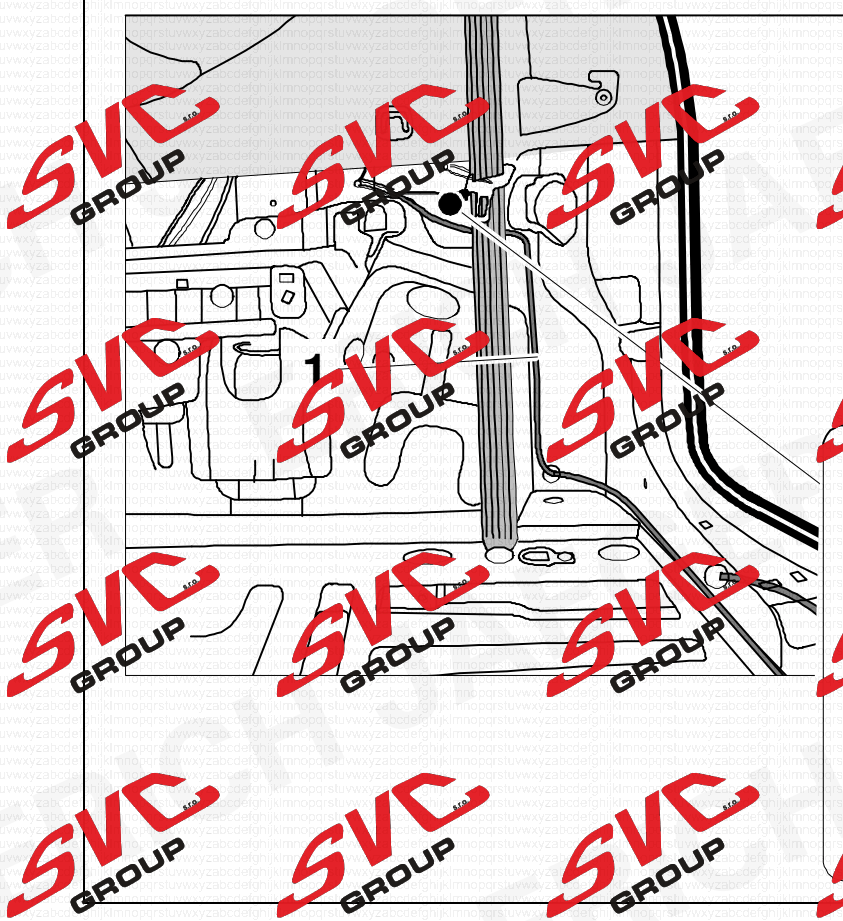

13

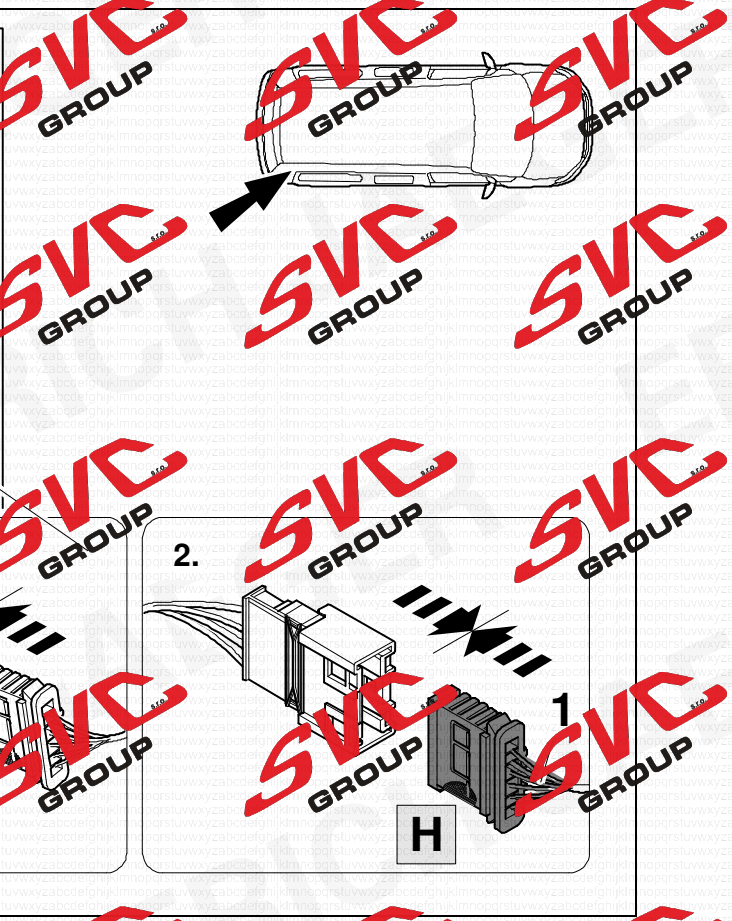

2433 10522EJH  
 © 2013 Jaeger GmbH + Co. KG, Straßheimer Str.10, D-93534 Friedberg,  
 Tel.: +49 (0) 6031 794 44 / e-mail: [skitsupport@erichjaeger.de](mailto:skitsupport@erichjaeger.de)



SVC GROUP SVC GROUP SVC GROUP SVC GROUP SVC GROUP SVC GROUP

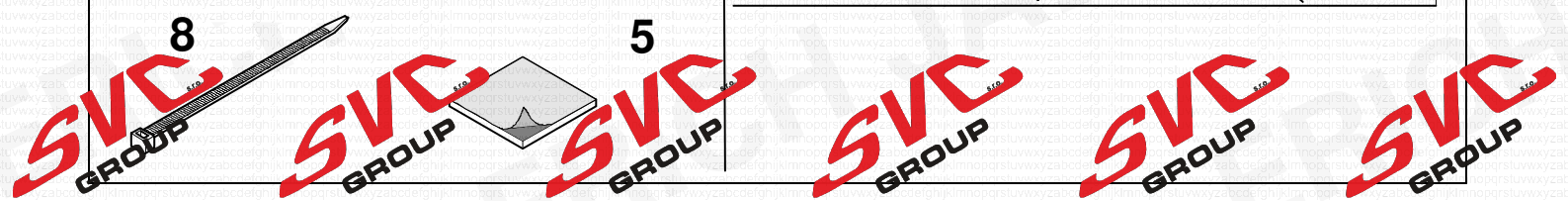
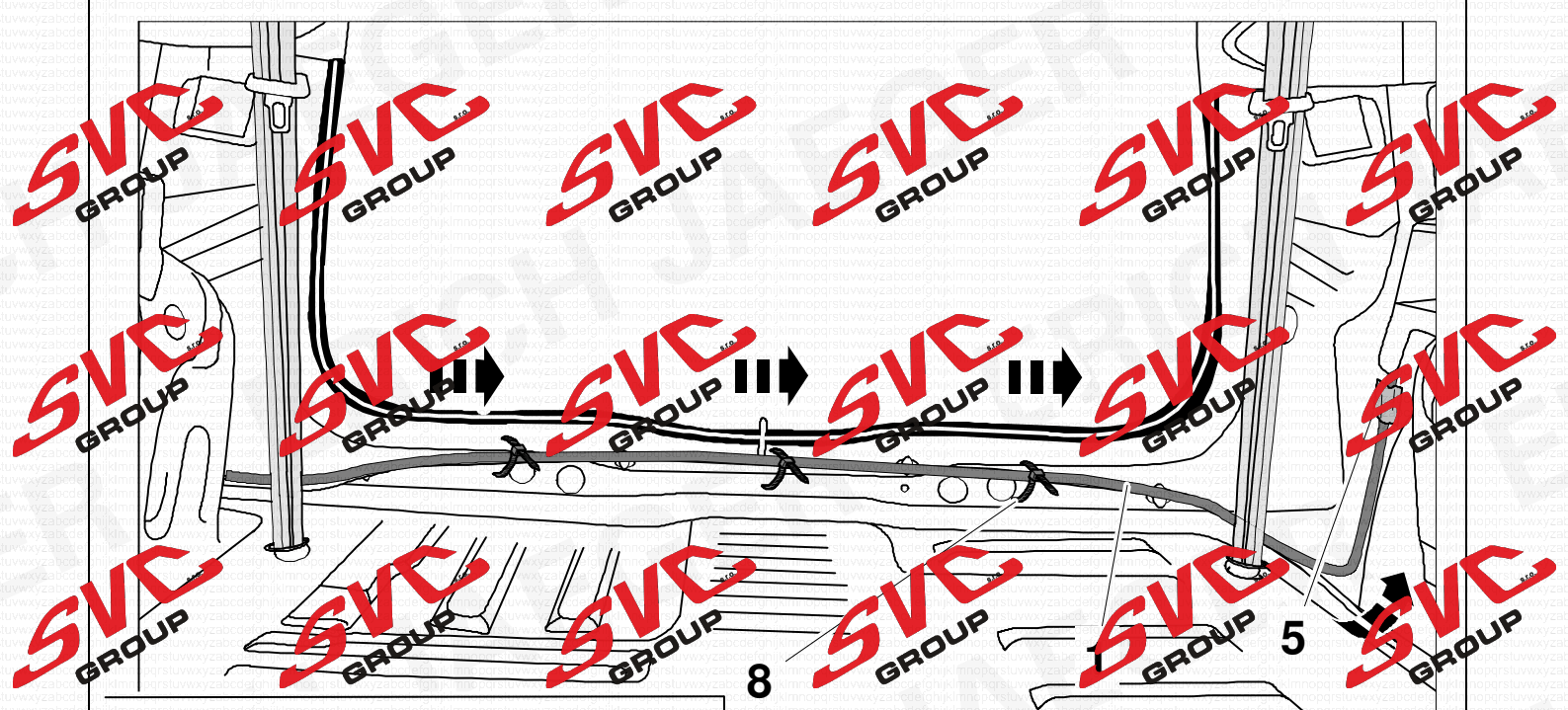

15

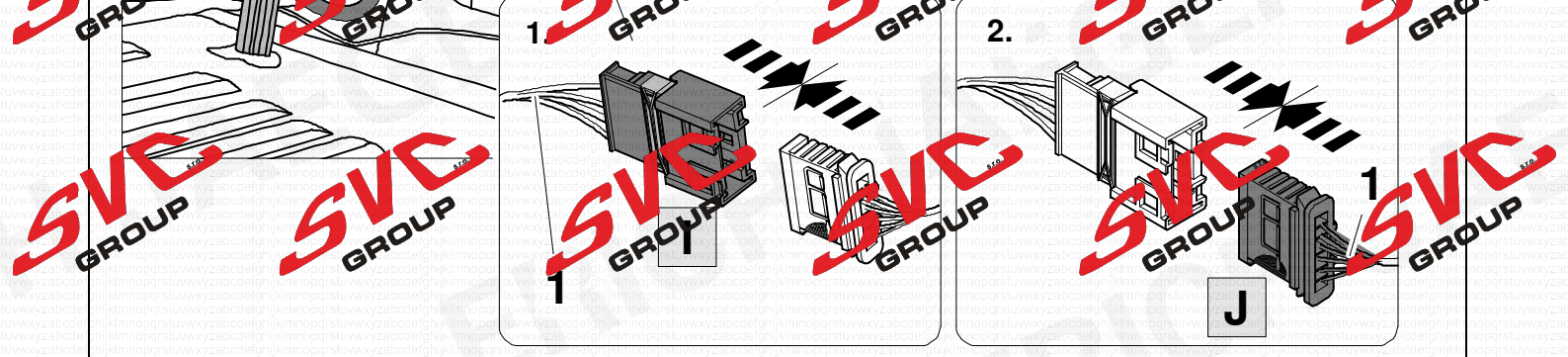
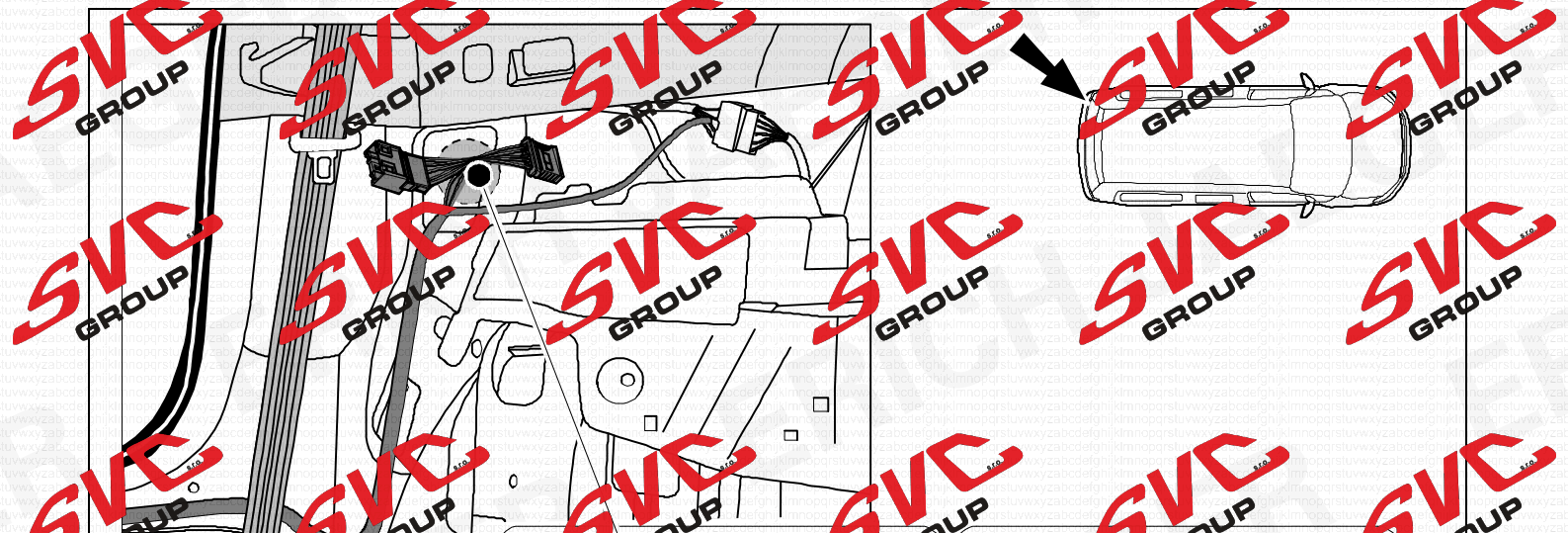

2433 10522EJH  
 Erich Jaeger GmbH + Co. KG, Straßheimer Str.10, D-93309 Friedberg,  
 Tel.: +49 (0) 6031 794-44 / e-mail: [skitsupport@erichjaeger.de](mailto:skitsupport@erichjaeger.de)  
 SVC GROUP SVC GROUP SVC GROUP SVC GROUP SVC GROUP SVC GROUP

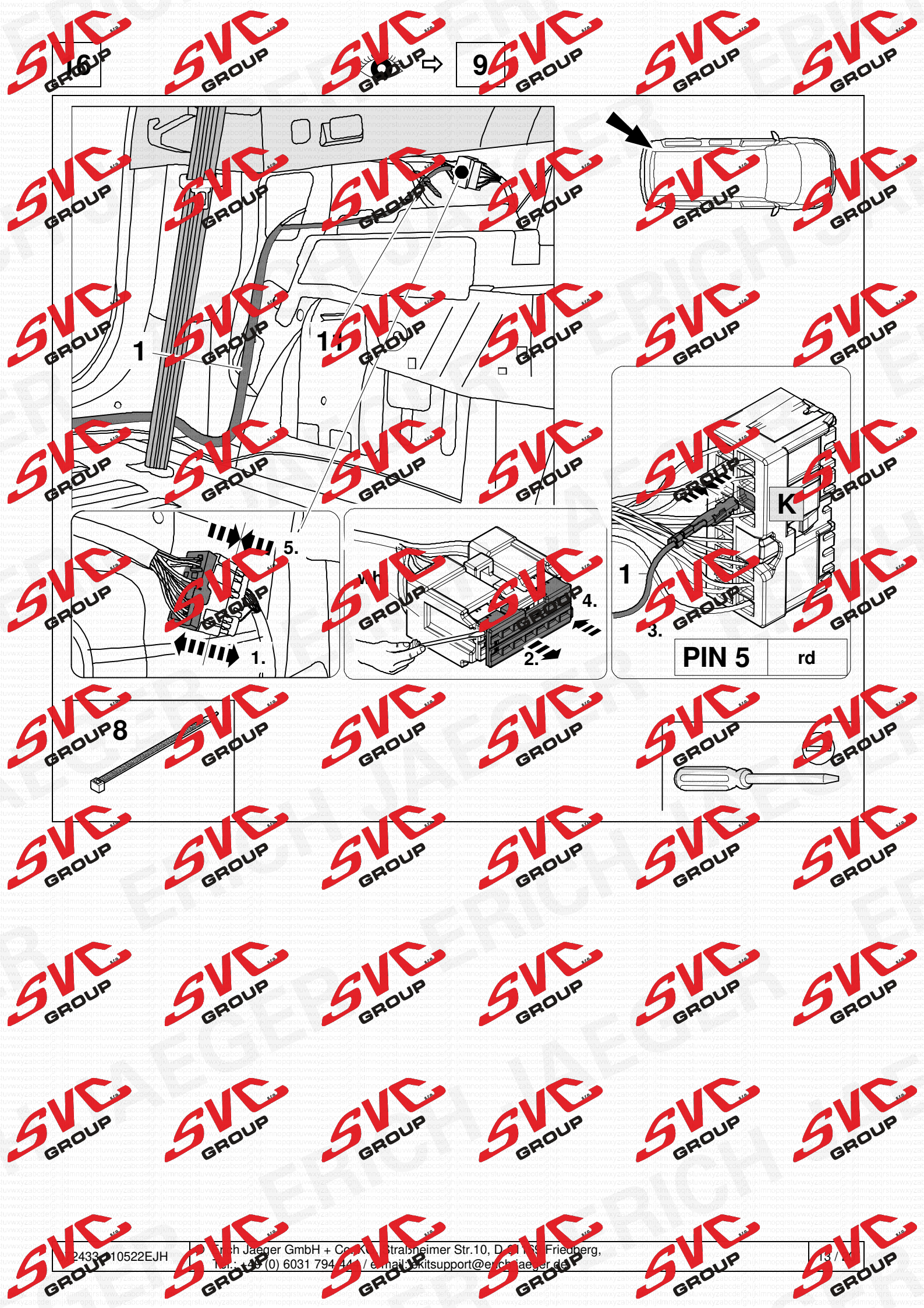

9

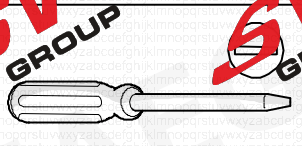
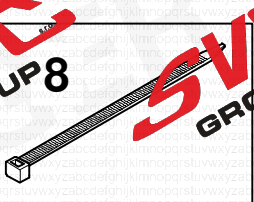
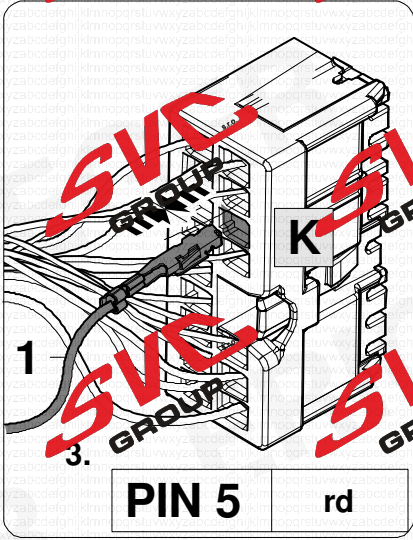
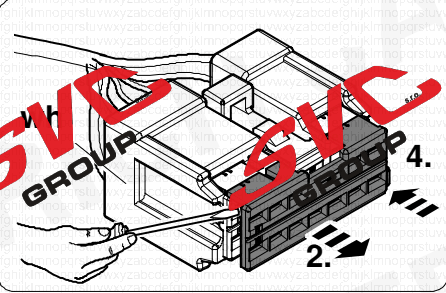
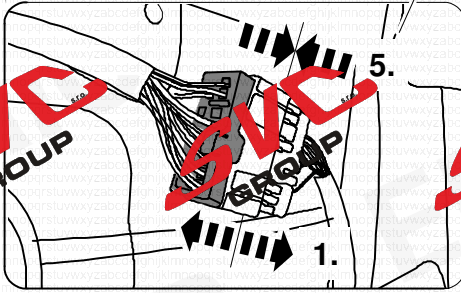
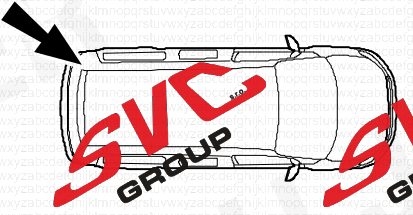
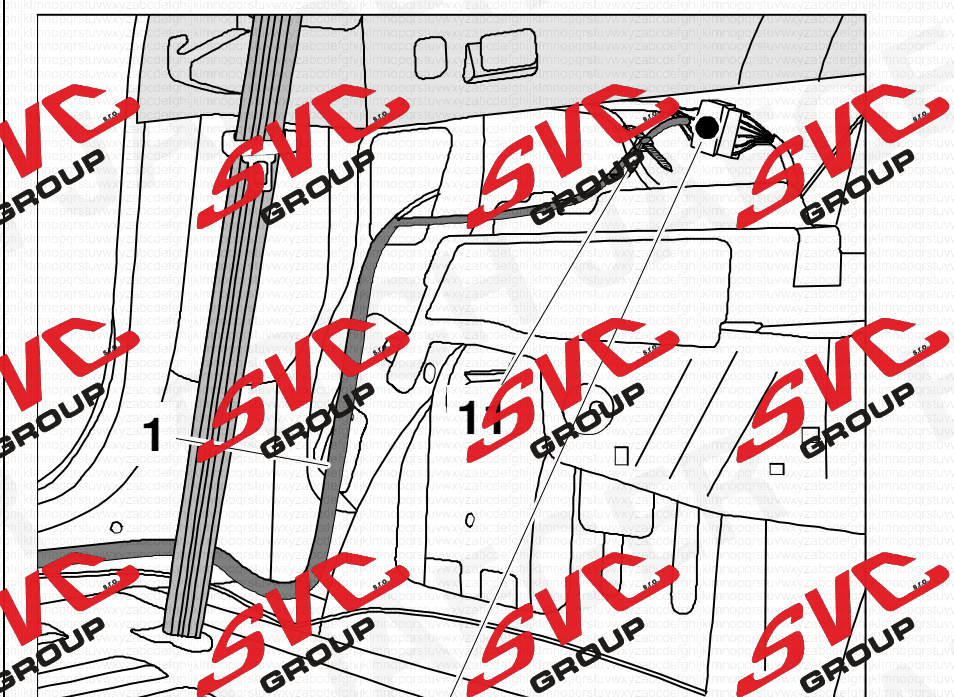



SVC GROUP SVC GROUP SVC GROUP SVC GROUP SVC GROUP

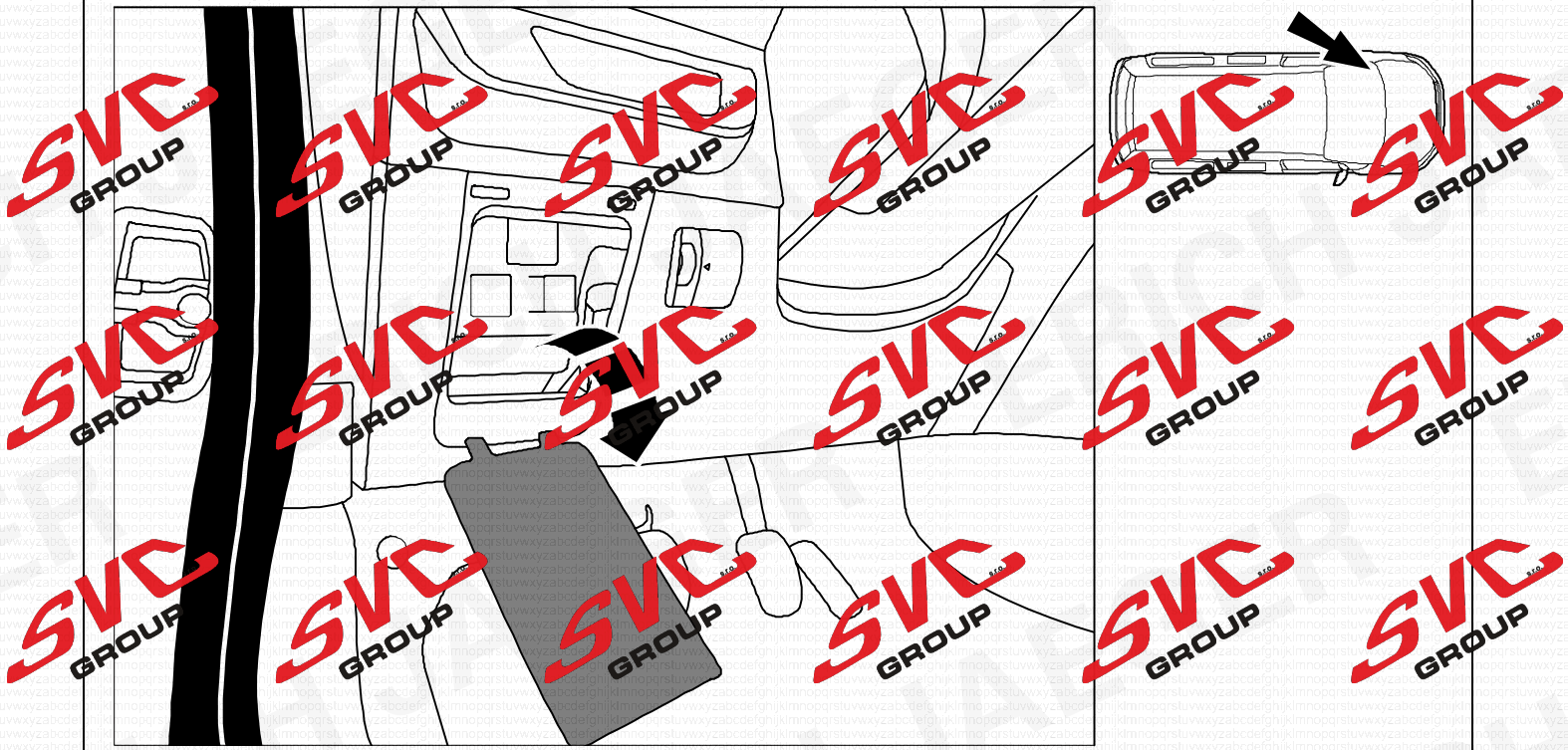

SVC GROUP SVC GROUP SVC GROUP SVC GROUP SVC GROUP

18  ⇌ 26

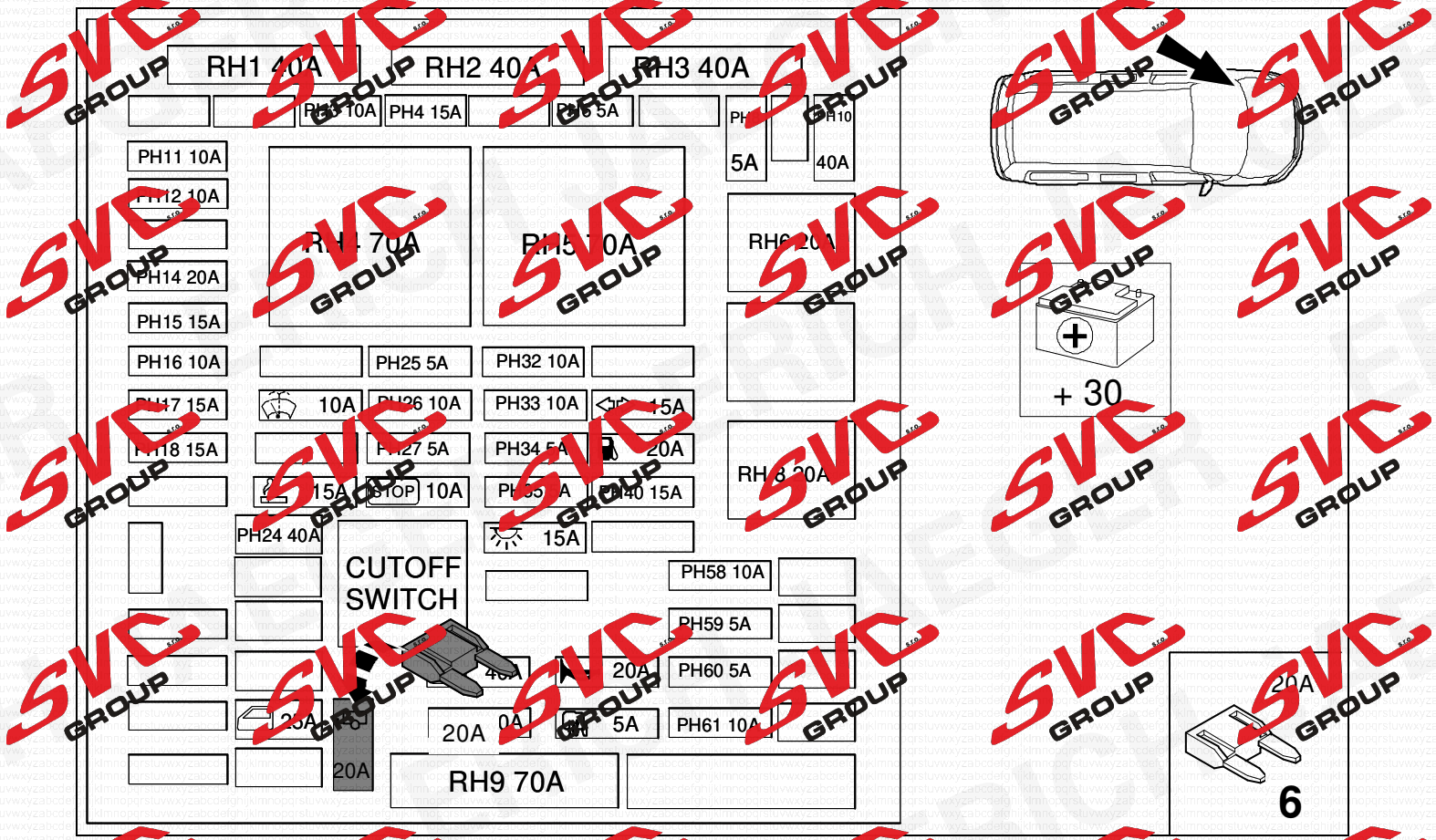

SVC GROUP SVC GROUP SVC GROUP SVC GROUP SVC GROUP

SVC GROUP

SVC GROUP

SVC GROUP

SVC GROUP

SVC GROUP

SVC GROUP

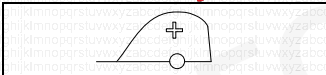

ERICH JAEGER Artikelnummer:  
ERICH JAEGER part number:

721075

SVC GROUP

SVC GROUP

SVC GROUP

SVC GROUP

SVC GROUP

SVC GROUP

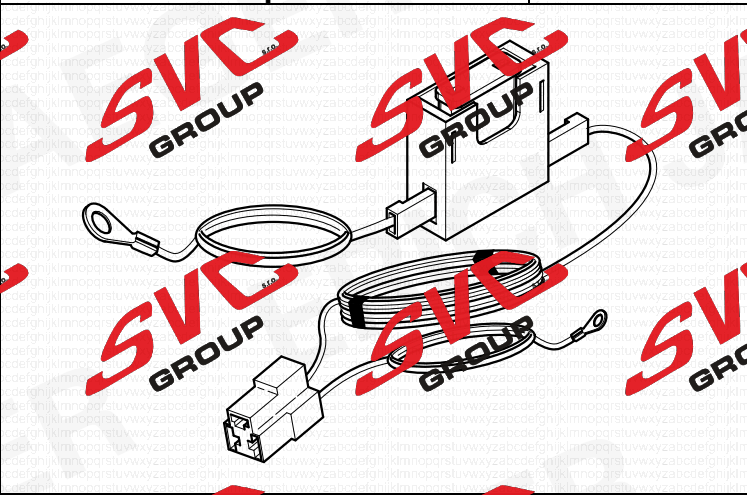
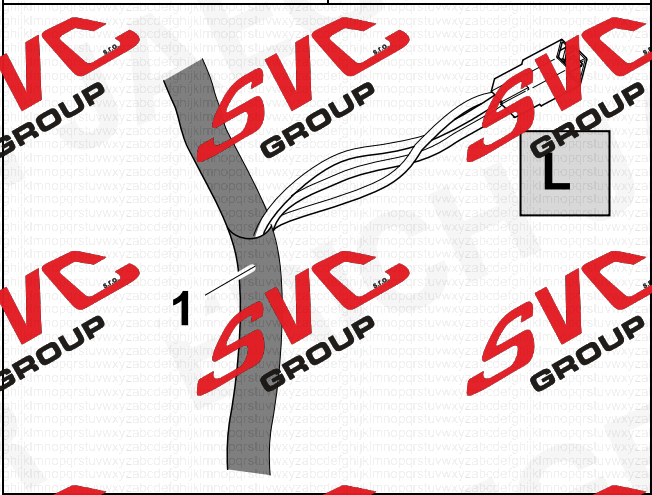

SVC GROUP

SVC GROUP

SVC GROUP

SVC GROUP

SVC GROUP

SVC GROUP

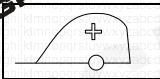

ERICH JAEGER Artikelnummer:  
ERICH JAEGER part number:

721077

SVC GROUP

SVC GROUP

SVC GROUP

SVC GROUP

SVC GROUP

SVC GROUP

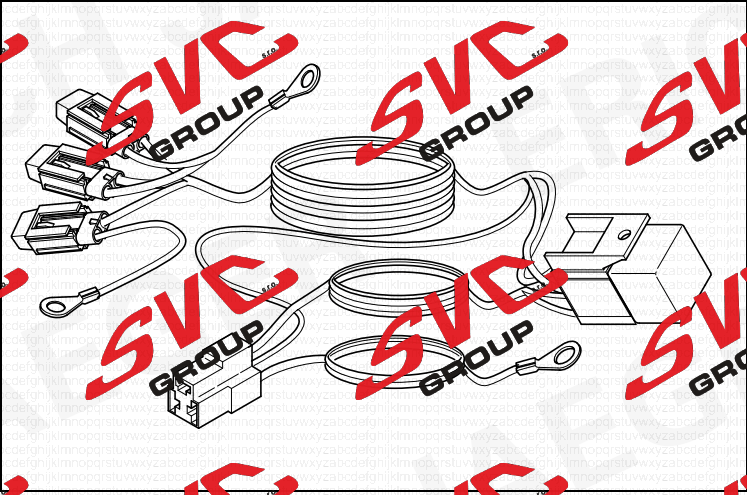
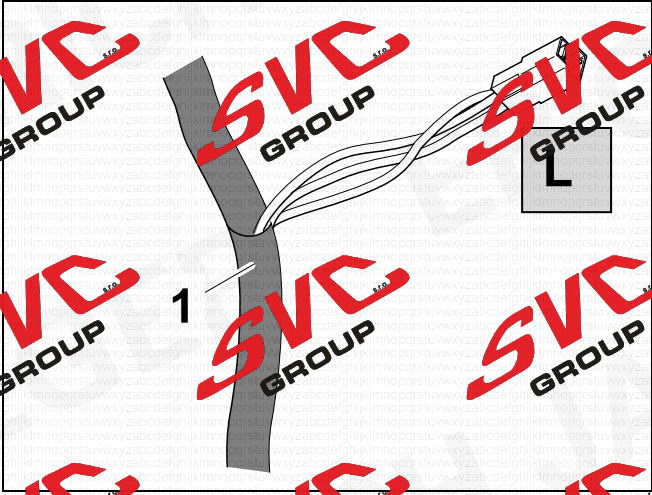

SVC GROUP

SVC GROUP

SVC GROUP

SVC GROUP

SVC GROUP

SVC GROUP

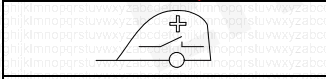

ERICH JAEGER Artikelnummer:  
ERICH JAEGER part number:

721074

SVC GROUP

SVC GROUP

SVC GROUP

SVC GROUP

SVC GROUP

SVC GROUP

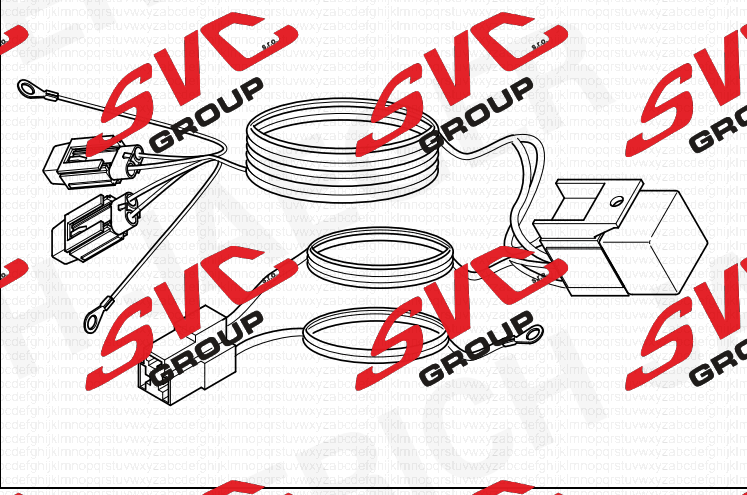
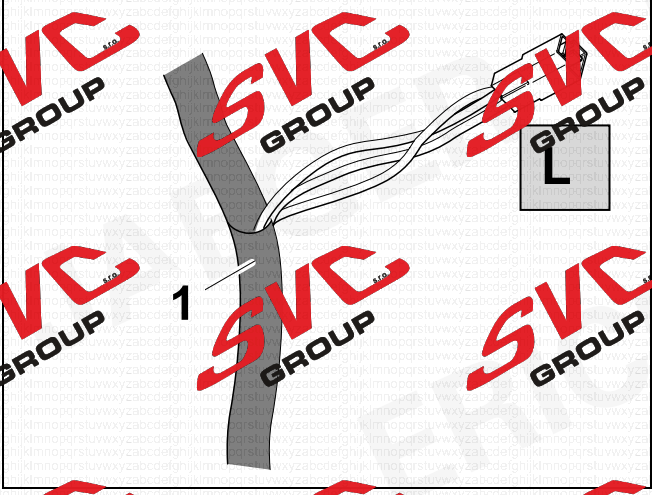

SVC GROUP

SVC GROUP

SVC GROUP

SVC GROUP

SVC GROUP

SVC GROUP



SVC GROUP SVC GROUP SVC GROUP SVC GROUP SVC GROUP



3 CHECK SVC GROUP SVC GROUP SVC GROUP SVC GROUP SVC GROUP

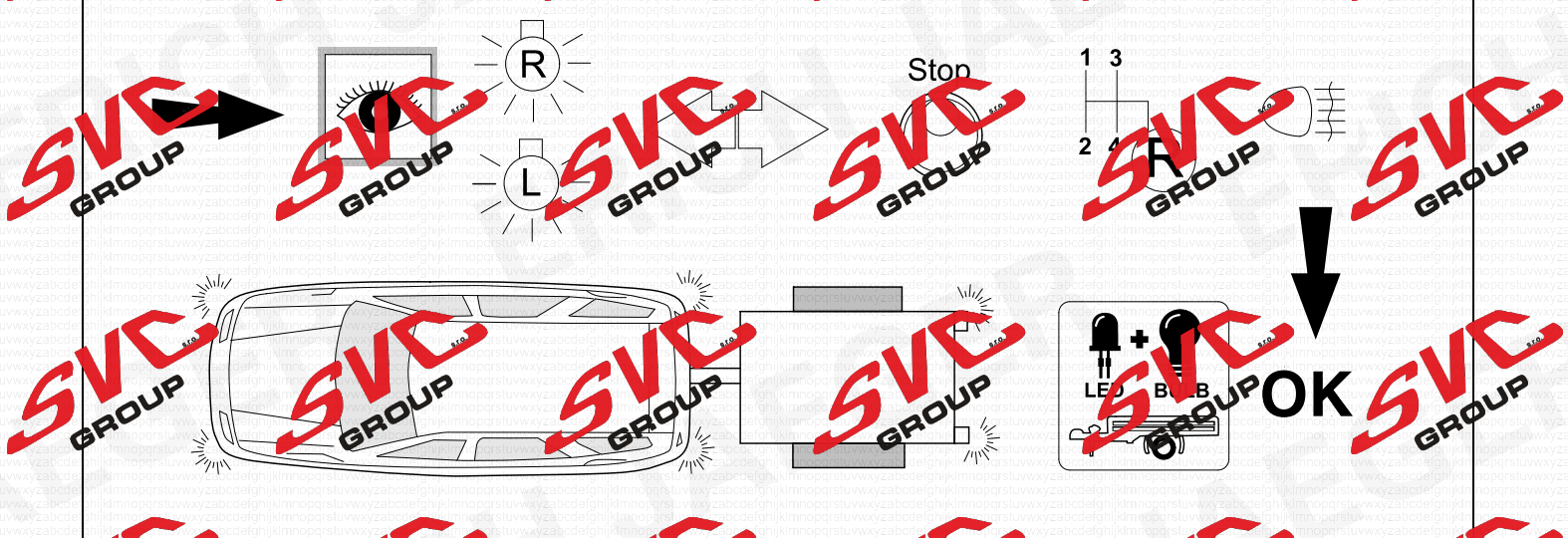

SVC GROUP SVC GROUP SVC GROUP SVC GROUP SVC GROUP

SVC GROUP SVC GROUP SVC GROUP SVC GROUP SVC GROUP

SVC GROUP SVC GROUP SVC GROUP SVC GROUP SVC GROUP

SVC GROUP SVC GROUP SVC GROUP SVC GROUP SVC GROUP

SVC GROUP SVC GROUP SVC GROUP SVC GROUP SVC GROUP

SVC GROUP SVC GROUP SVC GROUP SVC GROUP SVC GROUP

GROUP CHECK

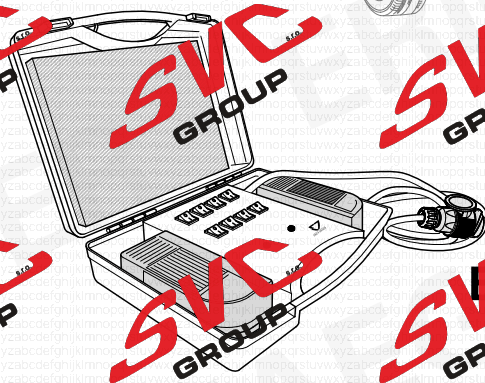
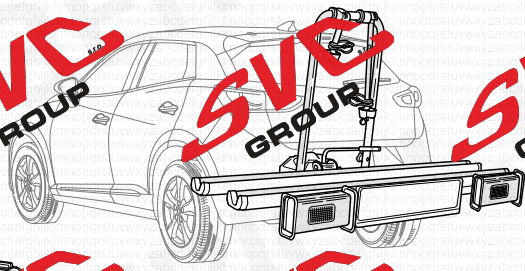
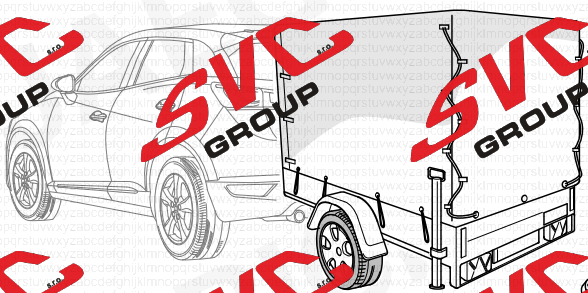

Part-no  
361062

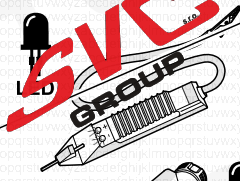
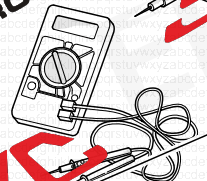

GROUP CHECK

1

1

2



2

3

3 / C

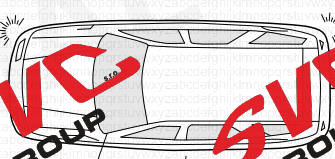



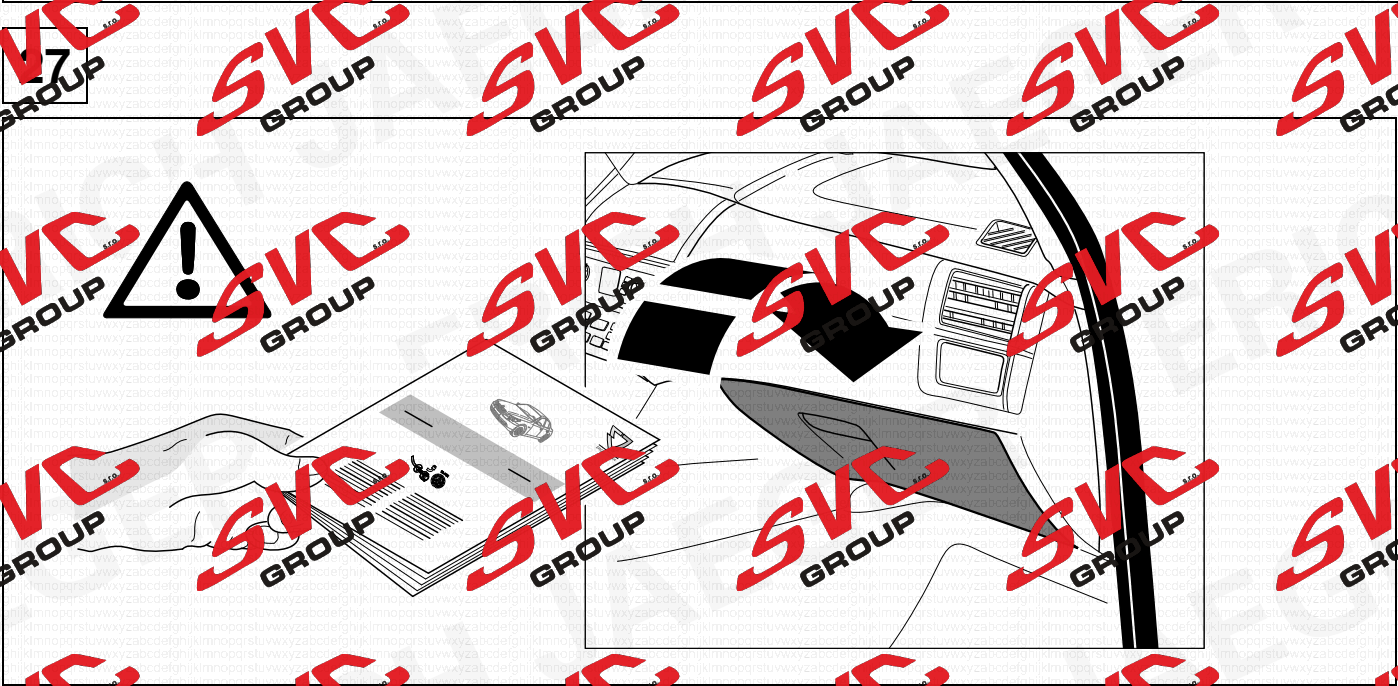
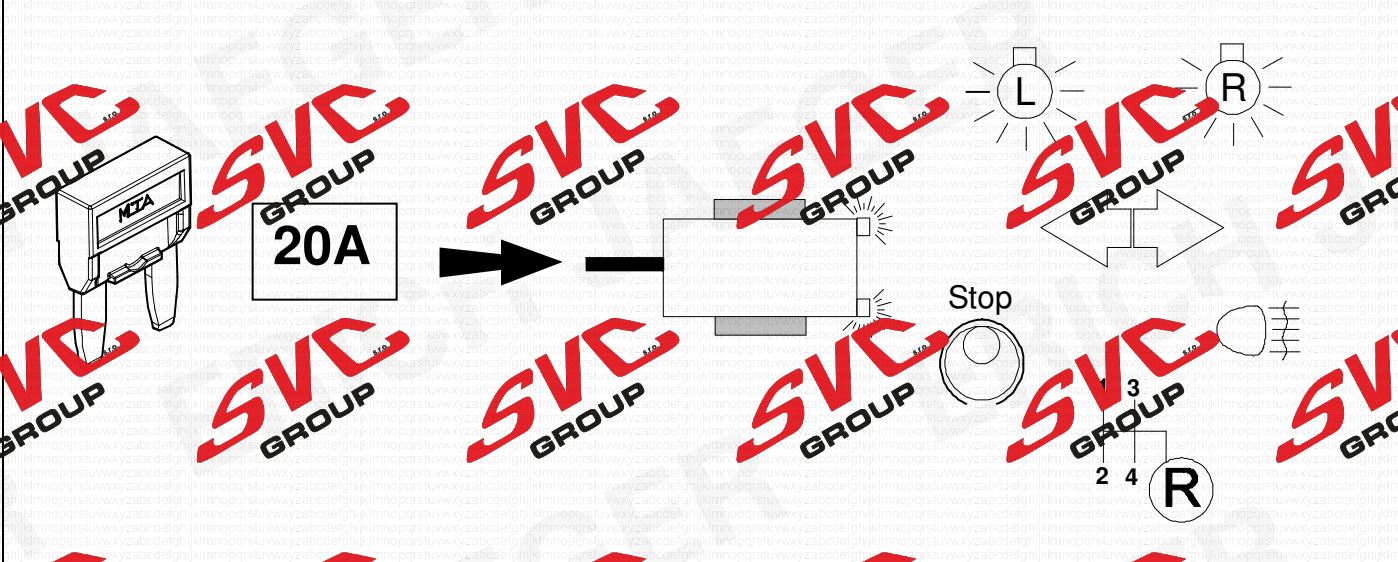





**(D)** Änderungen bezüglich Konstruktion, Ausstattung Farbe sowie Irrtum vorbehalten. Angaben und Abbildungen unverbindlich.

**(GB)** Subject to change in terms of construction, equipment and colour, and may contain errors. The information and illustrations are non-binding.

**(F)** Sous réserve de modifications de la construction, de l'équipement, de la couleur et sous réserve d'erreurs. Les indications et les illustrations sont sans engagement.

**(NL)** Wijzigingen met betrekking tot constructie, uitvoering en kleur evenals vergissingen voorbehouden. Gegevens en afbeeldingen niet bindend.

**(S)** Ändringar i konstruktion, utstyr, utrustning, färg samt för misstag. Uppgifterna i bilderna är inte bindande.

**(FIN)** Pidätämme oikeuden rakennetta, varustusta, väriä koskeviin sekä erehdyksestä johtuviin muutoksiin. Tiedot ja kuvat eivät ole sitovia.

**(I)** Con riserva di modifiche relative a progettazione, dotazione colore ed errori. Le indicazioni e figure sono fornite senza impegno.

**(E)** Reservadas las modificaciones respecto a diseño, equipamiento, color, así como error. Indicaciones y figuras sin compromiso.

**(P)** Reservamos o direito de alterações relativamente ao desenho, equipamento, cor, bem como de erro. Os dados e as gravuras não implicam compromisso da nossa parte.

**(GR)** Διατηρούμε το δικαίωμα αλλαγής ως προς όλα ή μερική αλλαγή με κατασκευή, εξοπλισμό, διαρρύθμιση χρωμάτων και λάθη παραδοσών.

**(CZ)** Změny, týkající se konstrukce, vybavení, barvy, jakož i omyly jsou vyhrazeny. Údaje a vyobrazení jsou nezávazné.

**(PL)** Zastrzega się prawo do zmian dot. konstrukcji, wykończenia, kolorystyki oraz pomylek. Dane i ilustracje niewiążące.

**(TR)** Tasarrufla, donanim ve renk bakım irin dan degişiklik yapma hakki ve neta ve eksiklik miholiz jur. veriler ve resimler bağlayıcı değildir.

**(H)** Szerkesztet, a kivitel és a szel változtatása, valamint a változások joga fenntartva. Az adatok és az ábrák nem kötelező érvényűek.

**(HR)** Pravo promjena u svezi konstrukcije, opreme, boje kao i zaburbe održavamo. Podaci i ilustracije su neobavezujuće.

**(BUL)** Запазваме права по отношение на конструкцията, оборудването, цвета и грешките. Данните и изображенията не са обвързващи.

**(RO)** Ne rezervăm dreptul unor modificări ale construcției, dotării, culorii și dreptul la erori. Datele indicate și imaginile sunt orientative.

**(RU)** Прerва на внесение изменений относительно конструкции, оснащения, цвета, а также на ошибки сохраняются. Данные и иллюстрации имеют примерный характер.

**(LT)** Pasiliekaama konstrukcijos, įrangos bei reikmenų spalvos pakeitimų ir klaidų teisė. Duomenys ir iliustracijos neįpareigojantys.

**(LV)** Tiek rauretas tiesības uz konstrukcijas, iekārtu, krāsu izmaiņām, kā arī kļūdiāšanas. Dati un attāli bez saistībām.

**(EST)** Konstruktiooni, varustuse ja varustosa muudatused ning eksimine lubatud. Andmed ja joonised on mittesiduvad.

**(SLO)** Zadržana pravica do sprememb glede konstrukcije, opreme, barve ter pomote. Podatki in slike so neobvezne.

**(SK)** Zadržany, ktoré sa týkajú konstrukcie, vybavenia, farby, ako a omyly sú vyhradené. Údaje a zobrazenia sú nezáväznej.

ERICH JAEGER Artikelnummer:  
ERICH JAEGER part number:

314069

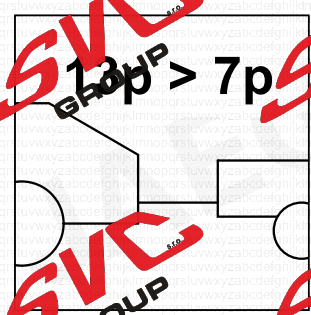
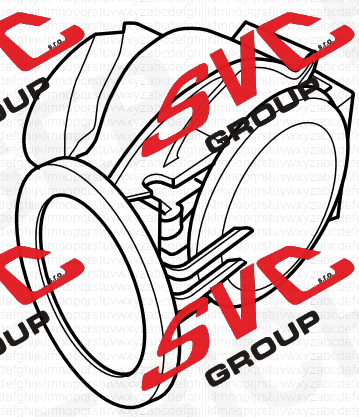

Nevíte si rady? Potřebujete poradit?

# Náš zákaznický servis je vám k dispozici

 +420 491 421 021

 [svc@svcgroup.cz](mailto:svc@svcgroup.cz)



Opravdový specialista a Certifikovaný výrobce tažných zařízení s největším sortimentem v ČR. Rodinná firma s více jak 30letou ověřenou tradicí výroby, prodeje a montáže.

[www.svcgroup.cz](http://www.svcgroup.cz)