

# Tažné zařízení ŠKODA SCALA Originální výrobek SVC Group s.r.o.

SK - Ťažné zariadenie GB - Towbars PL - Haki holownicze DE - Anhängavorrichtungen FR - Aŕelages SPA - Ganchos  
HUN - Vonohorgok RUS/FIN/LIT - Фаркопы RO - Cârlig de remorcare

TYP VTZ 001-511 VTZ 002-511 VTZ 003-511

www.svcgroup.cz



**SVC GROUP s.r.o.**  
Průmyslová zóna 179  
547 01 Náchod  
Česká Republika



Škoda Scala

2019 ->



1->2,0 h



2->2,5 h

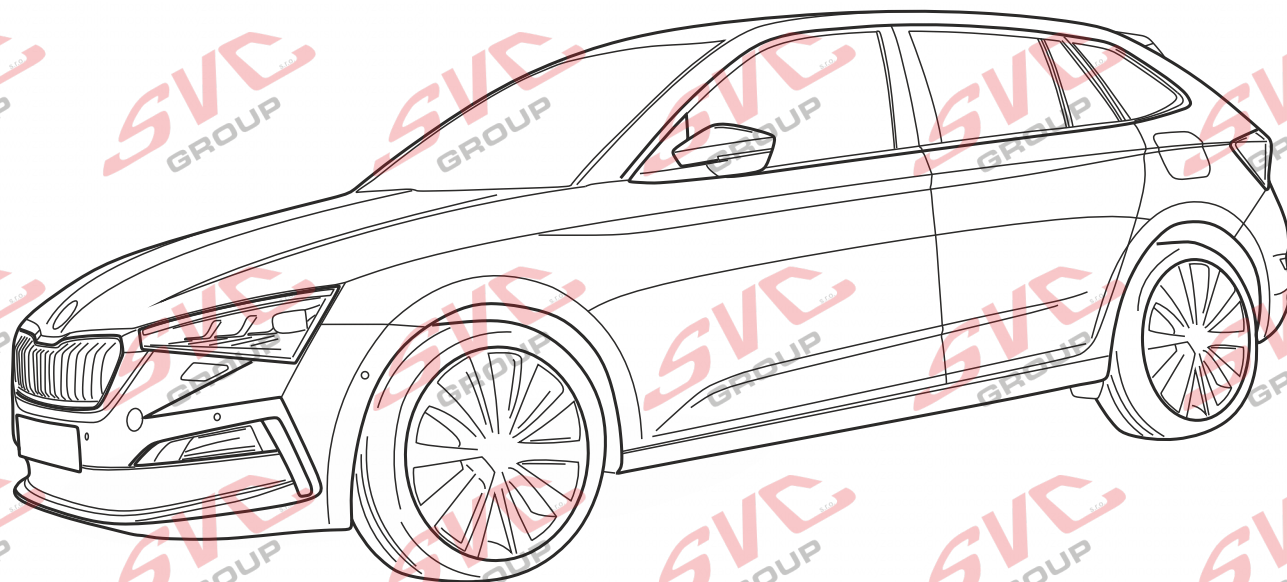
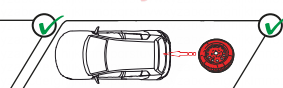

SCAN ME



CZ Pro podrobné montážní instrukce a podmínky výroby si naskenujte QR kód  
SK Pre podrobné montážne pokyny a podmienky produktu si môžete skenovať QR kód  
GB For detailed installation instructions and product conditions, scan the QR code  
DE Scannen Sie den QR-Code, um detaillierte Installationsanweisungen und Produktbedingungen zu erhalten  
FR Pour des instructions d'installation détaillées et les conditions du produit, scannez le code QR  
ITA Per istruzioni di installazione dettagliate e condizioni del prodotto, eseguire la scansione del codice QR  
PL Aby uzyskać szczegółowe instrukcje dotyczące instalacji i warunki produktu, zeskanuj kod QR  
SP Para obtener instrucciones detalladas de instalación y condiciones del producto, escanee el código QR  
NL Voor gedetailleerde installatie-instructies en productvoorwaarden, scan de QR-code  
FIN Tarkemmat asennusohjeet ja tuotteen ehdot on tarkistettava QR-koodilla  
HU A részletes telepítési utasítások és a termék feltételei között olvassa el a QR kódot  
SLO Za podrobna navodila za namestitve in pogoje izdelka skenirajte kodo QR  
RU Подробные инструкции по установке и условиям продукта отсканируйте QR-код.

SVC GROUP ©-11/19

e-mail: scv@scvgroup.cz Tel.: +420 491421021 +420 491421022 mob.: +420 603360607



Škoda Scala

r.v. 2019



**VTZ 001-511**

16.6



**A-511-2021**



**VTZ 002-511**

17.2



**A-511-2021**



**VTZ 003-511**

18.2



**AV-511-2021**



23/6000



1 600/95 D=8,22



55R-01-0551



1,5->2,0 h



2->2,5 h

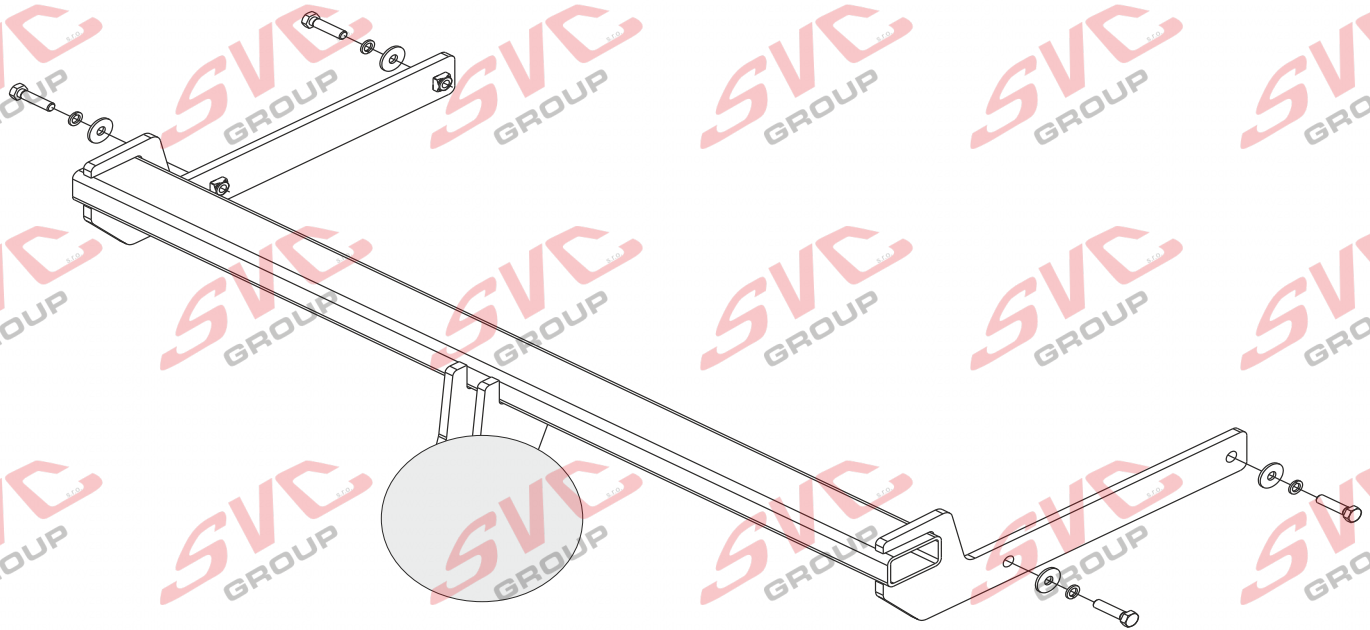

	M10x40 G10.9	4x	68 Nm
	Ø 10	4x	
	Ø 10	4x	
	1x SKL		

SVC GROUP



SVC GROUP s.r.o. Průmyslová zóna - 179 547 01 Náchod-ČR

www.svcgroup.cz  
e-mail: svc@svcgroup.cz

Tel.: +420 491 421 021  
+420 491 421 022  
mob.: +420 603 360 607

QR kódem si stáhnete si rozšířený montážní návod / With QR code you can download the extended assembly instructions

SVC GROUP ©- 05/19



Škoda Scala

r.v. 2019 -&gt;



VTZ 001-511



VTZ 002-511



VTZ 003-511

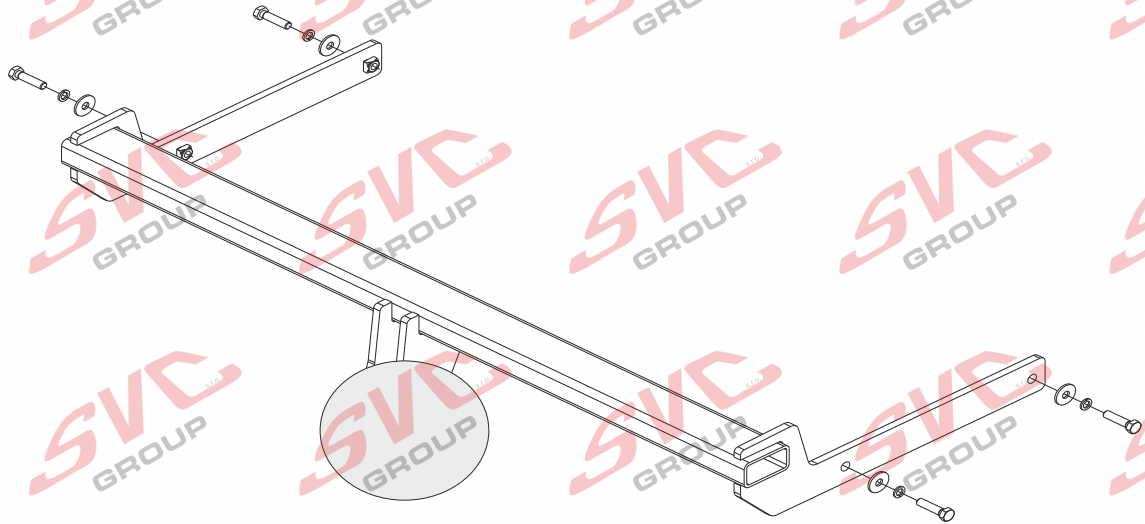
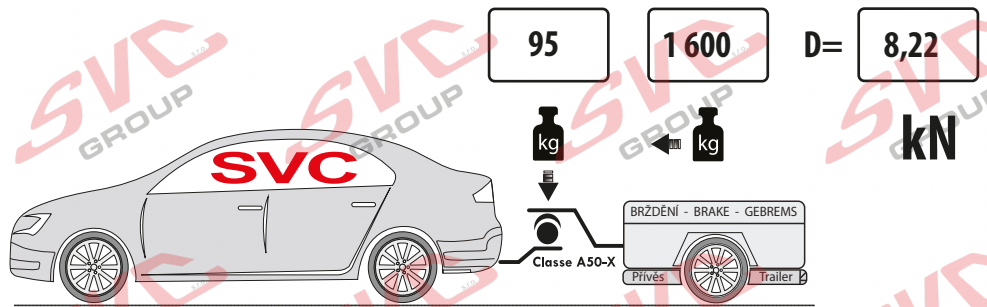

	M10x40	4x	68 Nm
	∅ 10	4x	
	∅ 10	4x	
	1x SKL		

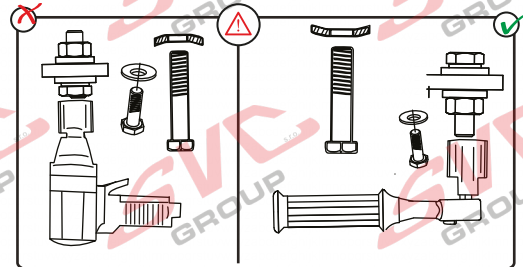

**i** **⚠** **👁**

Max -> 1000 km 0 km

<b>Pevnost</b>	<b>8,8</b>	<b>10,9</b>	<b>12,9</b>
<b>M6</b>	9,7	14,3	16,1
<b>M8</b>	24,5	35,9	42,0
<b>M10</b>	48,4	71,0	83,0
<b>M12</b>	84,0	123,0	144,0
<b>M14</b>	133,0	196,0	229,0
<b>M16</b>	137,0	307,0	359,0

Nm

**i** **⚠** Homologace EHK 55-R **55R-01-0551**

**Tiskněte a čístej!**

Approval Number Class **A50-X**  
**Bxx** 00-XXXX  
 Type \_\_\_\_\_ D-Value D \_\_\_\_\_ kN  
 Series \_\_\_\_\_ Vert.Id S \_\_\_\_\_ kg  
 www.svcgroup.cz - CZECH REPUBLIC

<b>CZ</b> Informace k provozu / homologaci	<b>NL</b> Monteringsanvisningar
<b>SK</b> Informácie na prevádzku / homologáciu	<b>ES</b> Instrucciones de montaje
<b>EN</b> Operating / homologation information	<b>FIN</b> Montage-instructie
<b>DE</b> Betriebs- / Zulassungsinformationen	<b>SV</b> Asennusohjeet
<b>HU</b> Üzemeltetési / homologációs információk	<b>NOR</b> Drifts- / homologasjonsinformasjon
<b>FR</b> Informations d'exploitation / homologatio	<b>PL</b> Informacje dotyczące pracy / homologacji
<b>IT</b> Informazioni sull'operazione / omologazio	<b>RU</b> Информация о работе / омологации



SVC GROUP s.r.o.

Průmyslová zóna - 179

www.svcgroup.cz

Tel.: +420 491421021

+420 491421022

547 01 Náchod-ČR

e-mail: svc@svcgroup.cz

mob.: +420 603360607

QR kódem si stáhnete si rozšířeny montážní návod / Mit QR-Code können Sie die erweiterte Montageanleitung herunterladen

SVC GROUP ©- 05/19

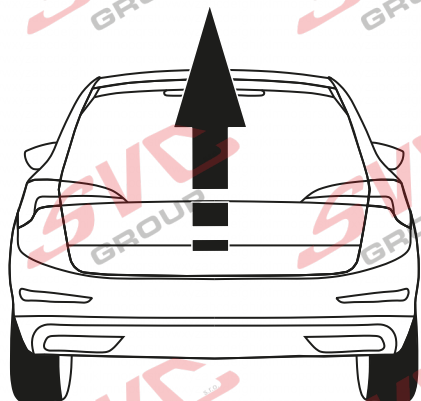

Montážní návod  
Montážny návod  
Installation instructions  
Installationsanleitung  
Instructions d'installation  
Инструкция по установке

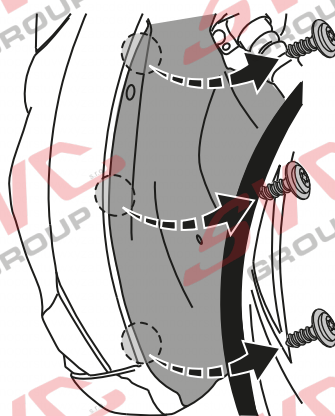
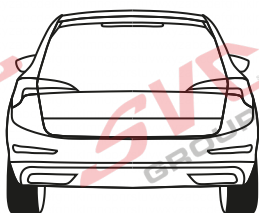

T20

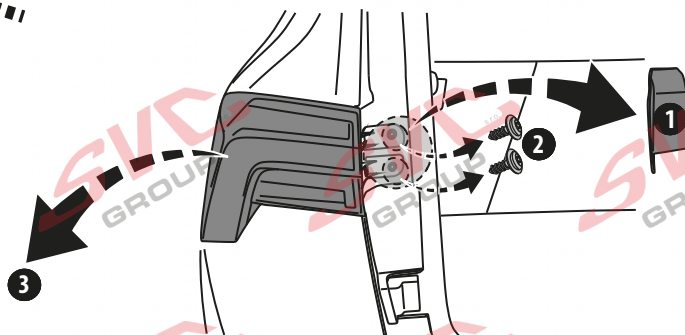
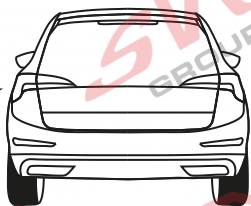

T15

4.

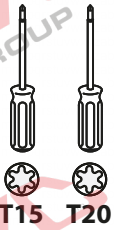
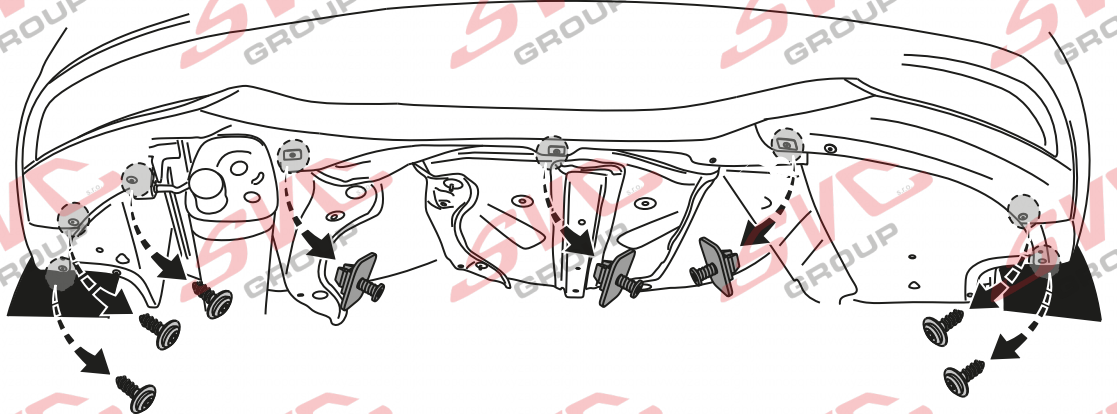
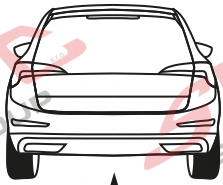

T15 T20



5.

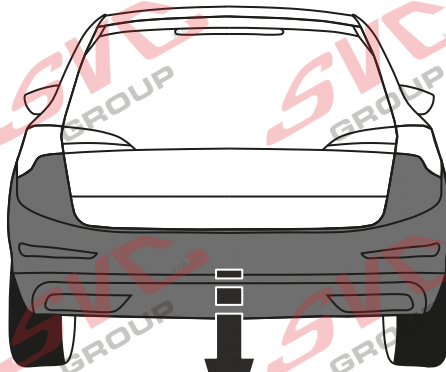

6.

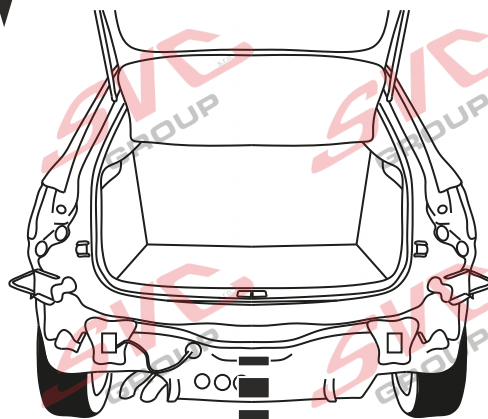

16



SVC GROUP s.r.o. Průmyslová zóna - 179 547 01 Náchod-ČR

www.svcgroup.cz  
e-mail: svc@svcgroup.cz

Tel.: +420 491 421 021  
+420 491 421 022  
mob.: +420 603 360 607

QR kódem stáhnete rozšířený montážní návod / За допомогою QR-коду ви можете завантажити розширені інструкції щодо складання

SVC GROUP © - 05/19

7.

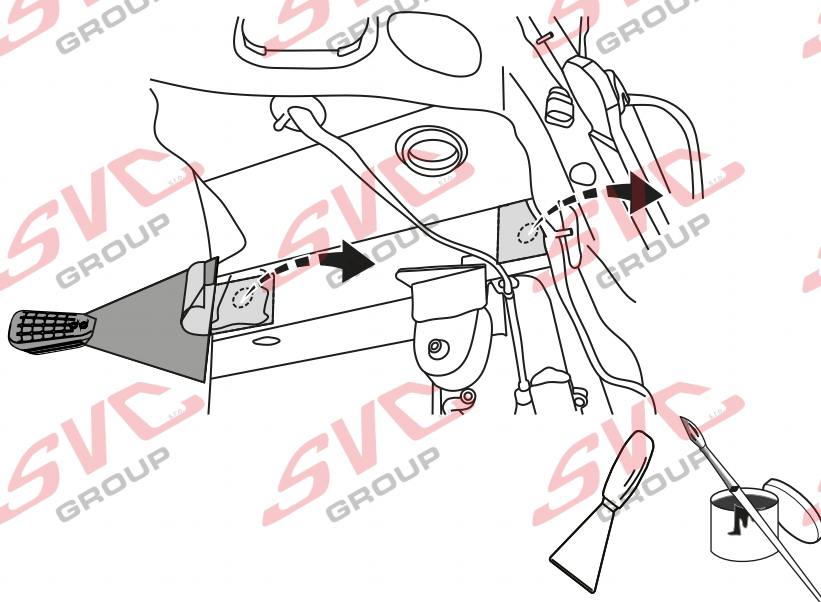
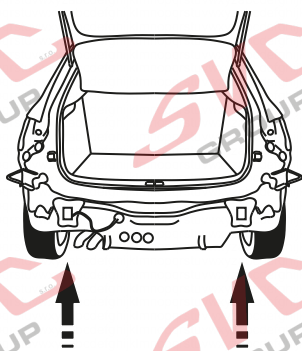

8.

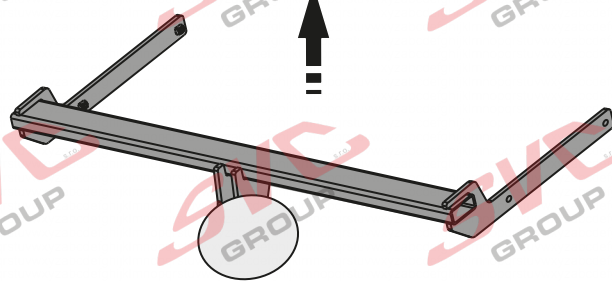
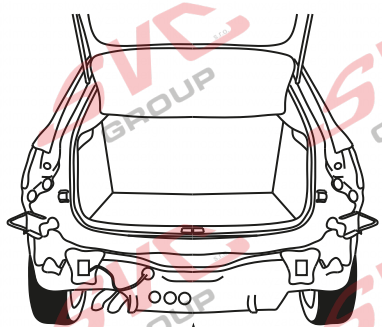
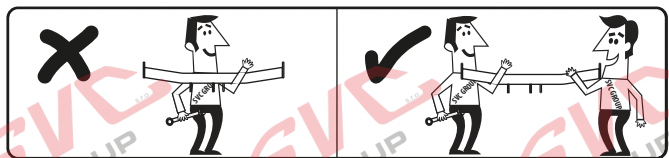

9.

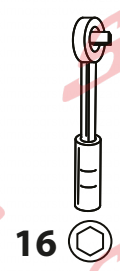
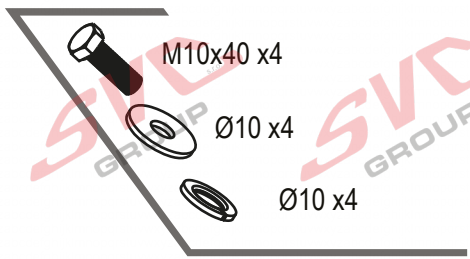
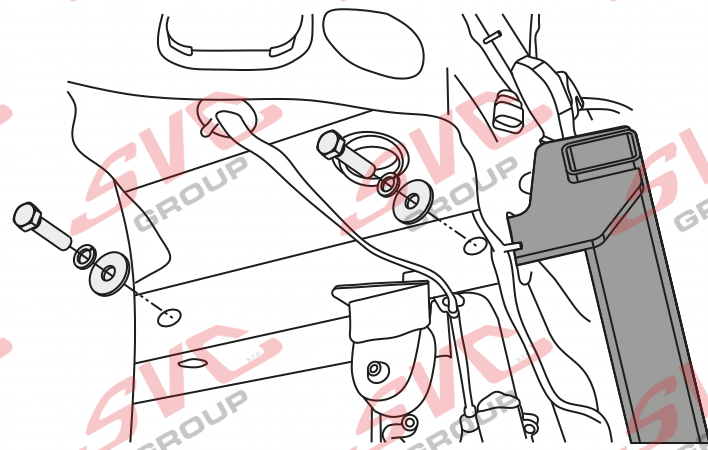
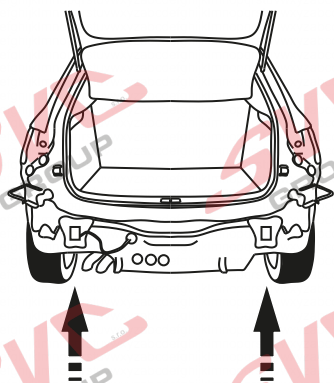

10.

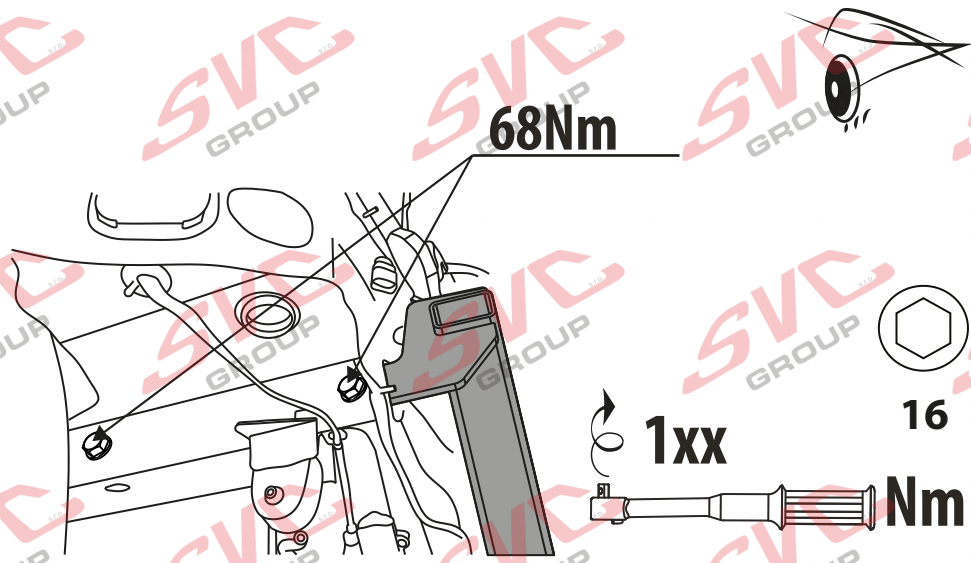
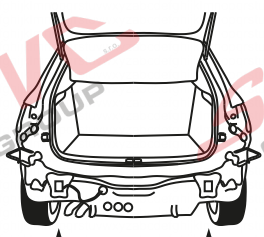

11.

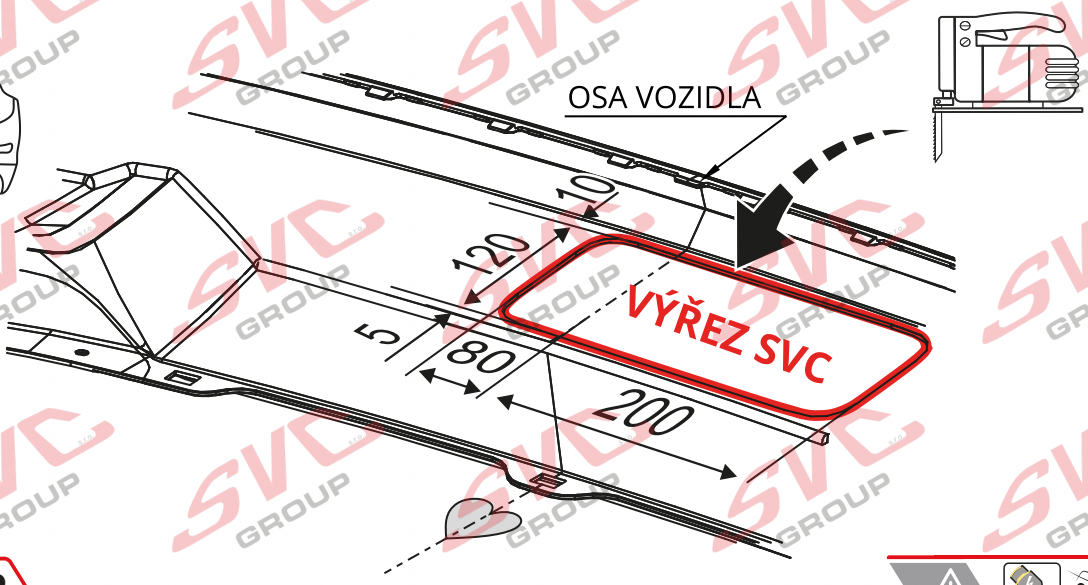
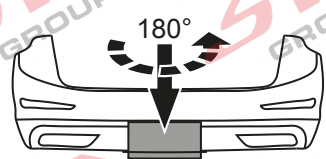

12.

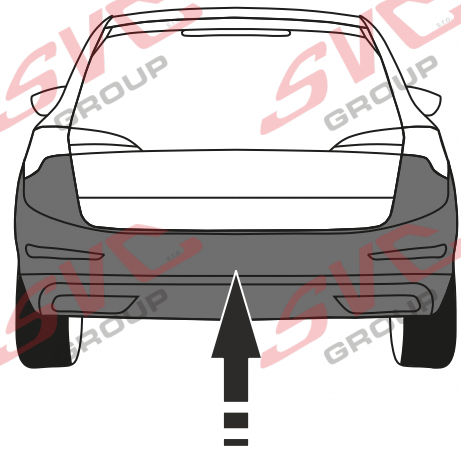

# ŠKODA SCALA

OSA VOZIDLA



VÝŘEZ SVC

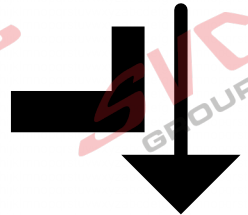

1:1

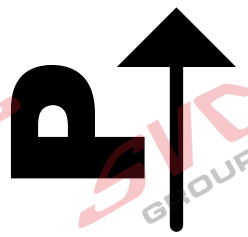



13.

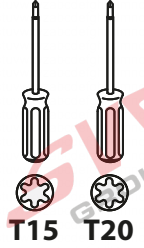
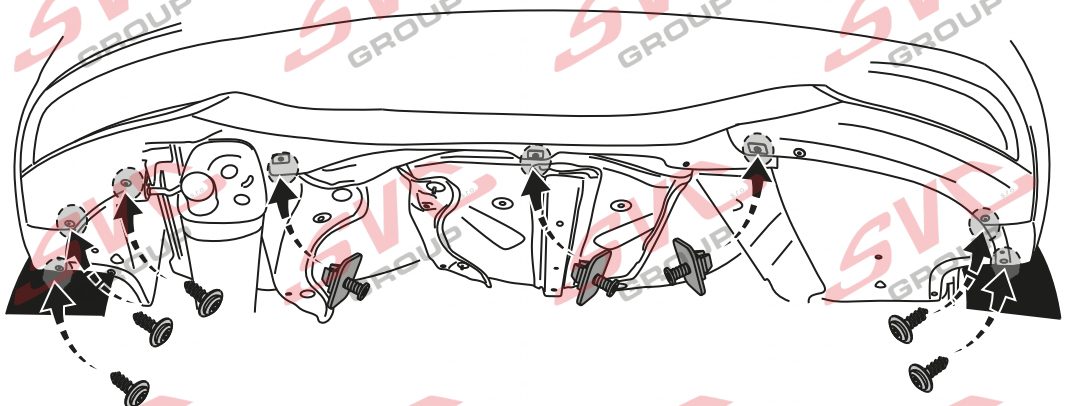
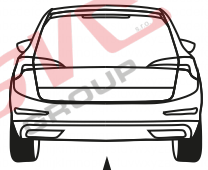

14.

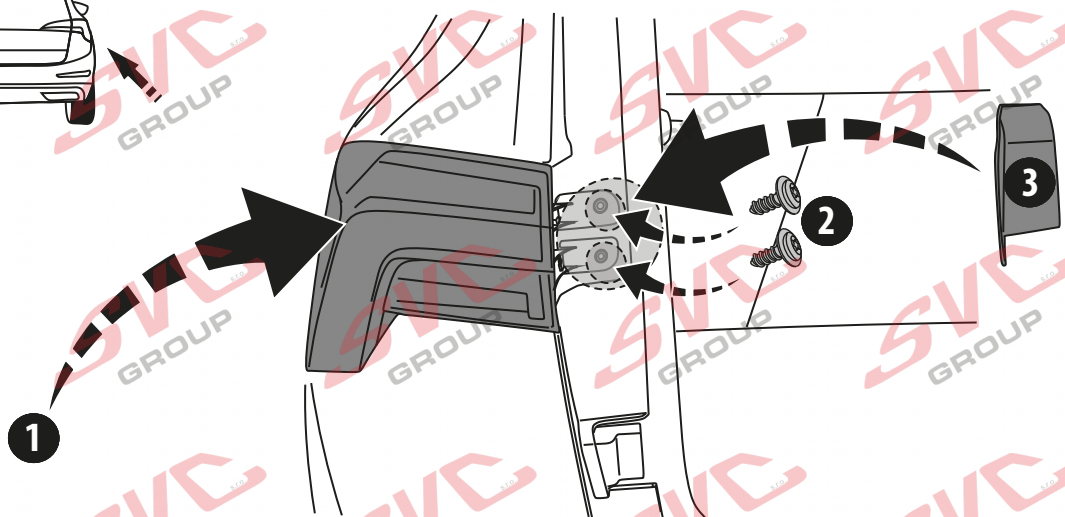
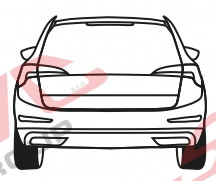

15.

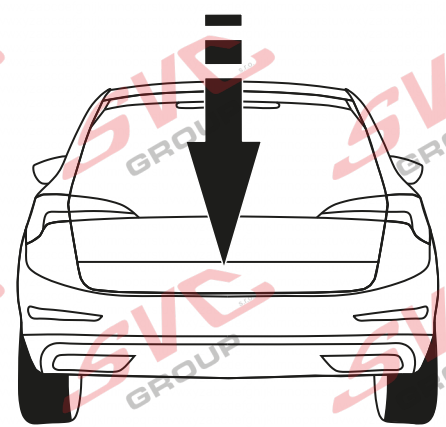
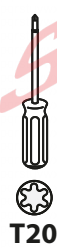
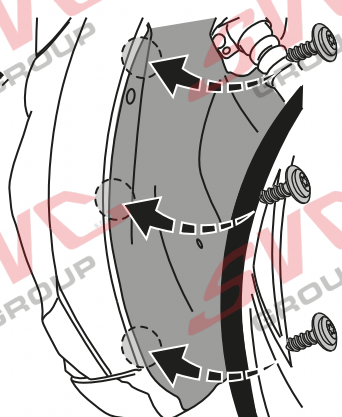
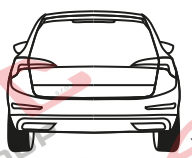

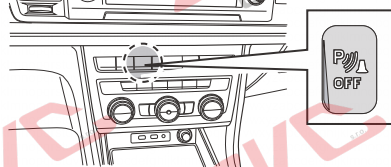
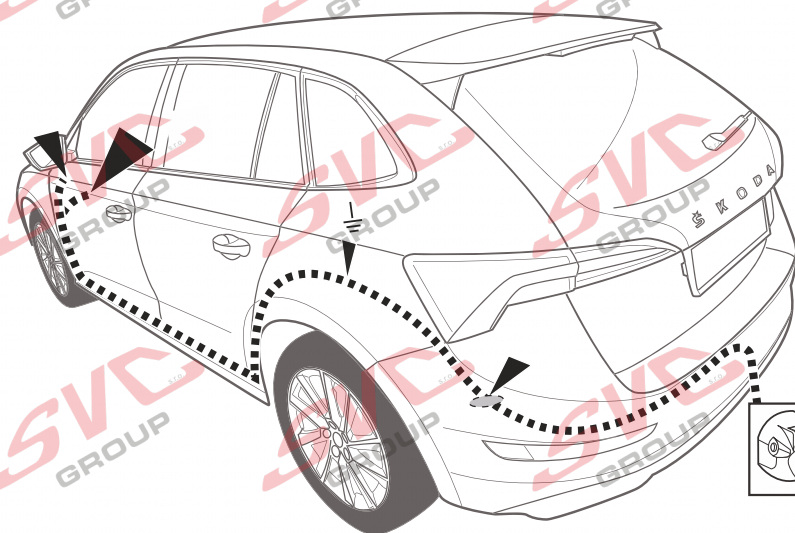

Informace pro odpojování couvacích senzorů PDC pro tažné zařízení

Vypínač pro vypínání couvacích senzorů PDC je umístěn na palubní desce vozu.

Nemusíte tedy pracně na elektro instalaci vozu napojovat odpojování couvacích senzorů PDC a zpětných kamer od elektro přípojky tažných zařízení.

Pokud chcete senzory vypnout, použijte vypínač na palubní desce.

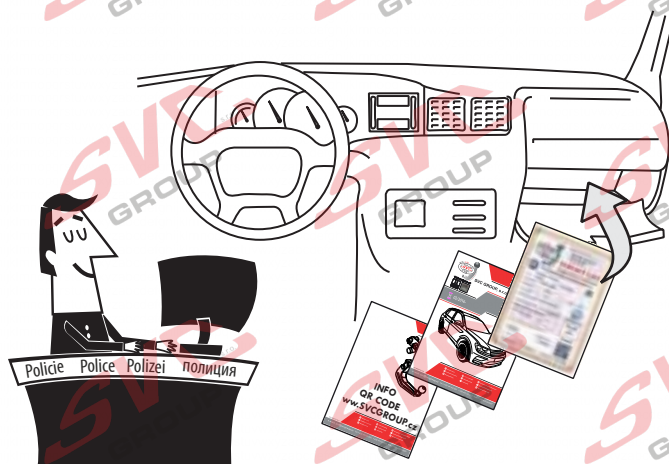
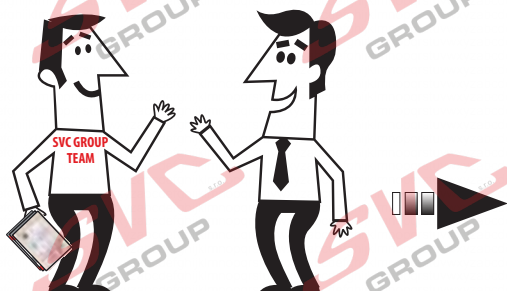

## SVC GROUP

Děkuje za důvěru / Դակւյէ շնորհակալութիւն ձեր հաւատարմութեան

Thank you for your trust / Danke Für dein Vertrauen

Merci pour votre conance / Grazie per la tua ducia

Tankewol foar jo fertrouwen / Спасибо за ваше доверие

Registrace / Registrácia

Registration / Registrierung

Inscription / Registrazione

Rekisteröinti / Регистрация

SVC GROUP ©- 15/2020



SVC GROUP s.r.o.

Průmyslová zóna - 179

547 01 Náchod-ČR

www.svcgroup.cz

e-mail: svc@svcgroup.cz

Tel.: +420 491421021

+420 491421022

mob.: +420 603360607

SVC GROUP ©- 05/19

QR kódem stáhnete rozšířený montážní návod / QR kódem stáhnete rozšířený montážní návod

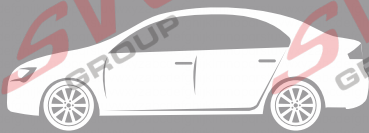

T-1

## CZ Informace k provozu / homologaci

Výrobek je vyráběn dle platných norem EHK-55 R pro prodej ve státech EU. Informace pro použití, provoz a záruky pro tažné zařízení naleznete na našem webu, [www.svcgroup.cz](http://www.svcgroup.cz)

Technické informace > Tažné zařízení > Všeobecné podmínky použití výrobku. Nebo si je stáhněte aplikace přes přiložený QR-cod

Součástí dodávky tažného zařízení je dodán TYPOVÝ LIST. Tento typový list slouží pro zapsání výrobku do technického průkazu vozidla, a obsahuje základní podmínky pro použití výrobku.

Typový list slouží i jako záruční lis proto jej uschovejte v dokumentaci vozidla.

## SK Informácie na prevádzku / homologáciu

Výrobok je vyrábaný podľa platných noriem EHK-55 R pre predaj v štátoch EÚ. Informácie pre použitie, prevádzku a záruky pre ťažné zariadenie nájdete na našom webe, [www.svcgroup.cz](http://www.svcgroup.cz)

Technické informácie > Ťažné zariadenie > Všeobecné podmienky použitia výrobku. Alebo si ich stiahnite aplikácie cez priložený QR-cod

Súčasťou dodávky ťažného zariadenia je dodaný TYPOVÝ LIST. Tento typový list slúži pre zapísanie výrobku do technického preukazu vozidla, a obsahuje základné podmienky použitia výrobku.

Typový list slúži aj ako záručný lis preto ho uschovajte v dokumentácii vozidla.

## EN Operating / homologation information

The product is manufactured according to the applicable EHK-55 R standards for sale in EU countries. Information on the use, operation and warranties for the towbar can be found on our website, [www.svcgroup.com](http://www.svcgroup.com)

Technical information > Towing hitch > General conditions of use. Or download them via QR-cod

The towing device is supplied with a TYPE SHEET. This data sheet is used to enter the product in the vehicle registration document and contains the basic conditions for use of the product.

The data sheet also serves as a warranty press, so keep it in the vehicle documentation.

## DE Betriebs / Zulassungsinformationen

Das Produkt wird gemäß den geltenden EHK-55 R-Standards für den Verkauf in EU-Ländern hergestellt. Informationen zu Verwendung, Betrieb und Gewährleistung der Anhängerkupplung finden Sie auf unserer Website [www.svcgroup.com](http://www.svcgroup.com)

Technische Informationen > Anhängerkupplung > Allgemeine Nutzungsbedingungen. Oder laden Sie sie per QR-Code herunter

Die Anhängervorrichtung wird mit einem TYPENBLATT geliefert. Dieses Datenblatt dient zur Eintragung des Produkts in das Kfz-Kennzeichen und enthält die Grundbedingungen für die Verwendung des Produkts. Das Datenblatt dient auch als Garantiepresse. Bewahren Sie es daher in der Fahrzeugdokumentation auf.

## HU Üzemeltetési / homologációs információk

Das Produkt wird gemäß den geltenden EHK-55 R-Standards für den Verkauf in EU-Ländern hergestellt. Informationen zu Verwendung, Betrieb und Gewährleistung der Anhängerkupplung finden Sie auf unserer Website [www.svcgroup.com](http://www.svcgroup.com)

Technische Informationen > Anhängerkupplung > Allgemeine Nutzungsbedingungen. Oder laden Sie sie per QR-Code herunter

Die Anhängervorrichtung wird mit einem TYPENBLATT geliefert. Dieses Datenblatt dient zur Eintragung des Produkts in das Kfz-Kennzeichen und enthält die Grundbedingungen für die Verwendung des Produkts. Das Datenblatt dient auch als Garantiepresse. Bewahren Sie es daher in der Fahrzeugdokumentation auf.

## FR Informations d'exploitation / homologation

Le produit est fabriqué conformément aux normes EHK-55 R applicables pour la vente dans les pays de l'UE. Des informations sur l'utilisation, le fonctionnement et les garanties de l'attelage sont disponibles sur notre site Web, [www.svcgroup.com](http://www.svcgroup.com).

Informations techniques > Attelage de remorquage > Conditions générales d'utilisation. Ou téléchargez-les via QR-cod

Le dispositif de remorquage est fourni avec une feuille de type. Cette fiche technique est utilisée pour entrer le produit dans le certificat d'immatriculation du véhicule et contient les conditions de base pour l'utilisation du produit. La fiche technique sert également de presse de garantie, conservez-la dans la documentation du véhicule.

## IT Informazioni sull'operazione / omologazione

Il prodotto è fabbricato secondo le norme EHK-55 R applicabili in vendita nei paesi dell'UE. Informazioni sull'uso, il funzionamento e le garanzie per il gancio di traino sono disponibili sul nostro sito Web [www.svcgroup.com](http://www.svcgroup.com)

Informazioni tecniche > Gancio di traino > Condizioni generali d'uso. Oppure scaricali tramite QR-cod

Il dispositivo di rimorchio viene fornito con una SCHEDA TIPO. Questa scheda tecnica viene utilizzata per inserire il prodotto nel certificato di immatricolazione del veicolo e contiene le condizioni di base per l'uso del prodotto. La scheda tecnica funge anche da stampa di garanzia, quindi conservala nella documentazione del veicolo.

**SVC GROUP s.r.o.**

Průmyslová zóna - 179

[www.svcgroup.cz](http://www.svcgroup.cz)

Tel.: +420 491 421 021

+420 491 421 022

547 01 Náchod-ČR

e-mail: [svc@svcgroup.cz](mailto:svc@svcgroup.cz)

mob.: +420 603360607

QR kódem stáhněte rozšířený montážní návod / QR-kóddal letöltés a kibővítés összeszerelési utasításokat

SVC GROUP ©- 05/19



T-2

### NL Monteringsanvisningar

Het product is vervaardigd volgens de toepasselijke EHK-55 R-normen voor verkoop in EU-landen. Informatie over het gebruik, de werking en de garanties voor de trekhaak vindt u op onze website, [www.svcgroup.com](http://www.svcgroup.com) *Technische informatie* > *Trekhaak* > *Algemene gebruiksvoorwaarden*. Of download ze via QR-cod  
Het sleepapparaat wordt geleverd met een TYPE BLAD. Dit gegevensblad wordt gebruikt om het product in het voertuigregistratiedocument in te voeren en bevat de basisvoorwaarden voor het gebruik van het product. Het gegevensblad dient ook als garantiepers, dus bewaar het in de voertuigdocumentatie.

### ES Instrucciones de montaje

El producto se fabrica de acuerdo con los estándares EHK-55 R aplicables para la venta en países de la UE. Puede encontrar información sobre el uso, el funcionamiento y las garantías de la barra de remolque en nuestro sitio web, [www.svcgroup.com](http://www.svcgroup.com) *Información técnica* > *Enganche de remolque* > *Condiciones generales de uso*. O descárguelos a través de QR-cod  
El dispositivo de remolque se suministra con una HOJA DE TIPO. Esta hoja de datos se utiliza para ingresar el producto en el documento de registro del vehículo y contiene las condiciones básicas para el uso del producto. La hoja de datos también sirve como una prensa de garantía, por lo tanto, consérvela en la documentación del vehículo.

### FIN Montage-instruktie

Tuote on valmistettu EU-maissa myytävien EHK-55 R -standardien mukaisesti. Tietoja vetokoukun käytöstä, käytöstä ja takuista löytyy verkkosivuiltamme [www.svcgroup.com](http://www.svcgroup.com) *Tekniset tiedot* > *Vetokoukku* > *Yleiset käyttöolosuhteet*. Tai lataa ne QR-koodin kautta  
Hinauslaite toimitetaan TYYPPI-ARKKI. Tätä lomaketta käytetään tuotteen syöttämiseen ajoneuvon rekisteröintitodistukseen, ja se sisältää tuotteen käytön perusedellytykset. Tietolomake toimii myös takuupuristimena, joten säilytä se ajoneuvon dokumenteissa.

SL

Izdelek je izdelan po veljavnih standardih EHK-55 R za prodajo v državah EU. Informacije o uporabi, delovanju in garancijah za vlečno ploščo najdete na našem spletnem mestu [www.svcgroup.com](http://www.svcgroup.com) *Tehnični podatki* > *Vlečna kljuka* > *Splašni pogoji uporabe*. Ali pa jih prenesite preko QR-kod  
Vlečna naprava je opremljena s TIPNIM LISTOM. Ta podatkovni list se uporablja za vnos izdelka v registracijski dokument vozila in vsebuje osnovne pogoje za uporabo izdelka. Podatkovni list služi tudi kot garancijski tisk, zato ga hranite v dokumentaciji vozila.

### NOR Drifts- / homologasjonsinformasjon

Produktet er produsert i henhold til gjeldende EHK-55 R standarder for salg i EU-land. Informasjon om bruk, drift og garantier for tilhengerfeste finner du på vår hjemmeside, [www.svcgroup.com](http://www.svcgroup.com) *Teknisk informasjon* > *Tilhengerfeste* > *Generelle bruksbetingelser*. Eller last dem ned via QR-koding  
Tøaeanordningen leveres med TYPEBLAD. Dette databladet brukes til å oppgi produktet i kjøretøyets registreringsbevis og inneholder de grunnleggende betingelsene for bruk av produktet. Databladet fungerer også som garantipresse, så hold det i bilens dokumentasjon.

### PL Informacje dotyczące pracy / homologacji

Produkt jest wytwarzany zgodnie z obowiązującymi normami EHK-55 R na sprzedaż w krajach UE. Informacje na temat użytkowania, obsługi i gwarancji na hak holowniczy można znaleźć na naszej stronie internetowej [www.svcgroup.com](http://www.svcgroup.com) *Informacje techniczne* > *Żaczep holowniczy* > *Ogólne warunki użytkowania*. Lub pobierz je za pomocą kodu QR  
Urządzenie holownicze jest dostarczane z ARKUSZEM TYPU. Ta karta danych służy do wpisania produktu do dokumentu rejestracyjnego pojazdu i zawiera podstawowe warunki użytkowania produktu. Karta danych służy również jako prasa gwarancyjna, dlatego przechowuj ją w dokumentacji pojazdu.

### RU Информация о работе /омологации

El producto se fabrica de acuerdo con los estándares EHK-55 R aplicables para la venta en países de la UE. Puede encontrar información sobre el uso, el funcionamiento y las garantías de la barra de remolque en nuestro sitio web, [www.svcgroup.com](http://www.svcgroup.com) *Información técnica* > *Enganche de remolque* > *Condiciones generales de uso*. O descárguelos a través de QR-cod  
El dispositivo de remolque se suministra con una HOJA DE TIPO. Esta hoja de datos se utiliza para ingresar el producto en el documento de registro del vehículo y contiene las condiciones básicas para el uso del producto. La hoja de datos también sirve como una prensa de garantía, por lo tanto, consérvela en la documentación del vehículo.



SVC GROUP s.r.o. Průmyslová zóna - 179 547 01 Náchod-ČR

[www.svcgroup.cz](http://www.svcgroup.cz)  
e-mail: [svc@svcgroup.cz](mailto:svc@svcgroup.cz)

Tel.: +420 491 421 021  
+420 491 421 022  
mob.: +420 603 360 607

QR kódem stáhnete rozšířený montážní návod / Con il codice QR è possibile scaricare le istruzioni di assemblaggio estese

SVC GROUP ©- 05/19





**CZ** Pozor informace k záruce  
**SK** Pozor informácie k záruke  
**EN** Note the warranty information  
**DE** Beachten Sie die Garantieinformationen

**HU** Vegye gyelembe a jótállási információkat  
**FR** Notez les informations de garantie  
**IT** Nota le informazioni sulla garanzia  
**NL** Let op de garantie-informatie

**ES** Atención  
**FIN** Huomio  
**PL** Uwaga  
**RU** Внимание

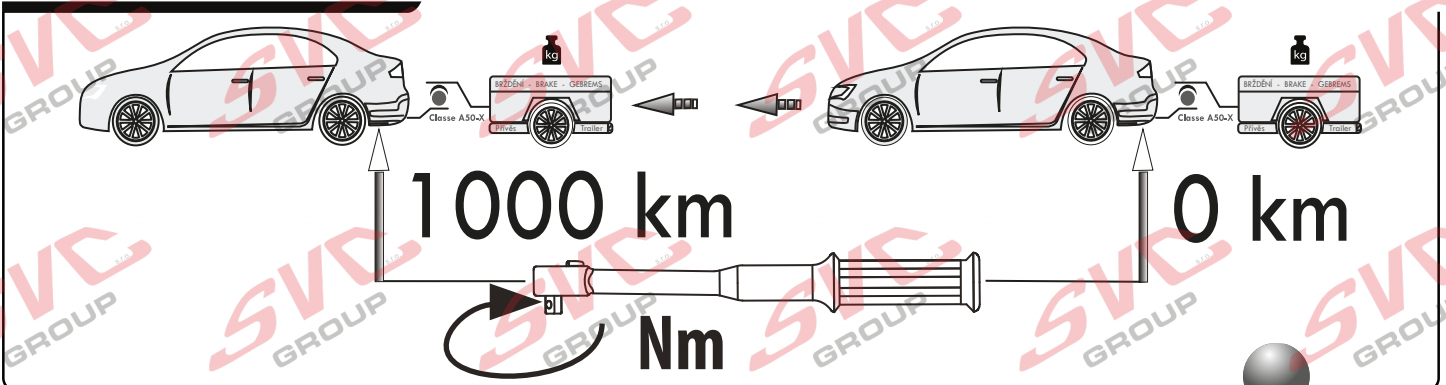
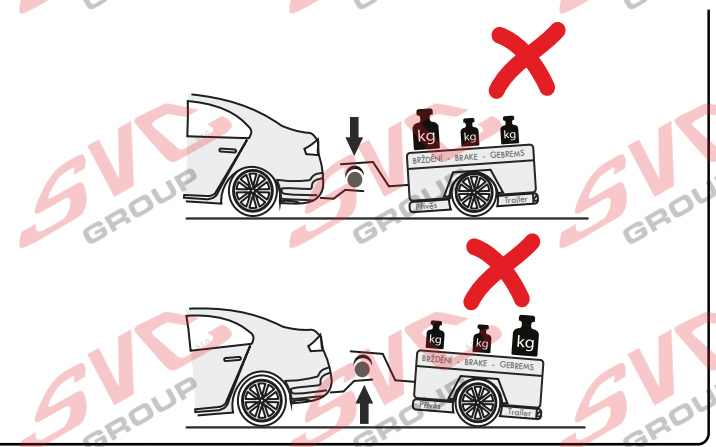
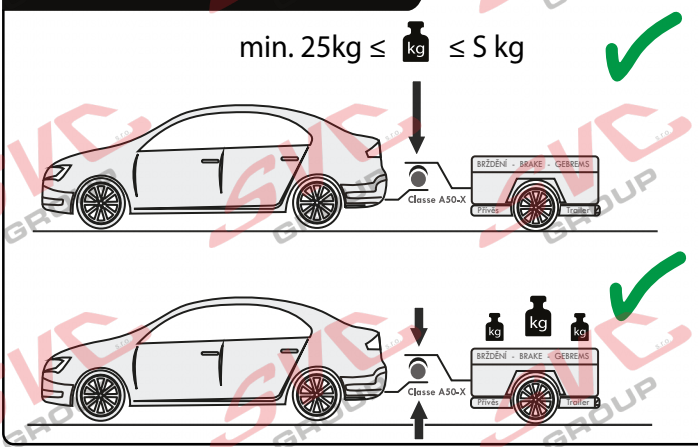
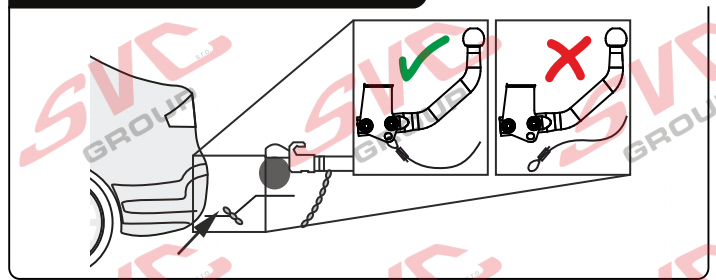
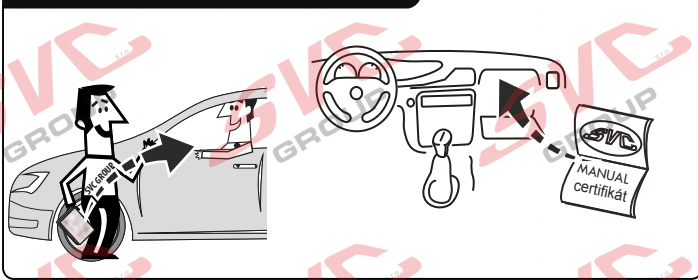
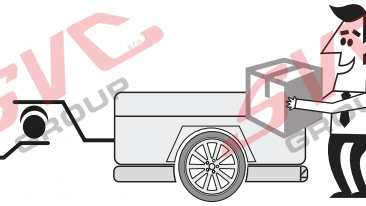
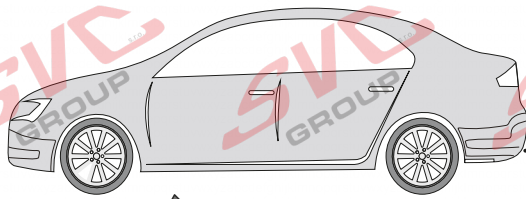

Vysokov 179  
 547 01 Náchod, Česká Republika

+420 603 360 607 +420 491421021



www.svcgroup.cz

SVC GROUP ©-08-2019

Service Vítver Centrum



**CZ** Pozor informace k záruce  
**SK** Pozor informácie k záruke  
**EN** Note the warranty information  
**DE** Beachten Sie die Garantieinformationen

**HU** Vegye gyelembe a jótállási információkat  
**FR** Notez les informations de garantie  
**IT** Nota le informazioni sulla garanzia  
**NL** Let op de garantie-informatie

**ES** Atención  
**FIN** Huomio  
**PL** Uwaga  
**RU** Внимание

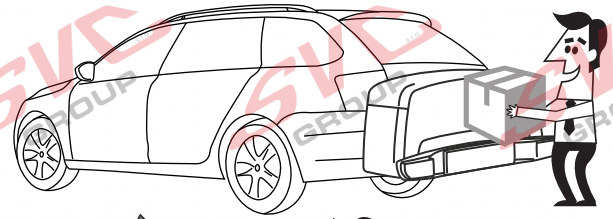
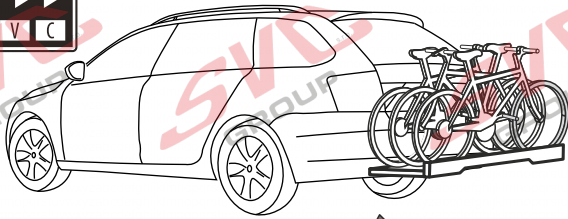

**i** **!** **!**

+ **3** + **1** ≤ **max. manual**

**max. manual**

1   
 2   
 3

**i** **!** **!**

+ ≤ **max. manual**

**max. manual**

3 **1** **2**

**i** **!** **!**

**MAX. 5 km/h** (km/h)

**i** **!** **!**

123

123

Vysokov 179  
 547 01 Náchod, Česká Republika

+420 603 360 607 +420 491421021



www.svcgroup.cz

Service Vítver Centrum