

Montážní návod

(Montážny návod, Fitting instruction, Montageanleitung,
Istruzioni di montaggio, Monteringshandledning,
Asennusohje, Instruction de montage,
Montagehandleiding, Инструкция по установке)



Elektropřípojka

Mercedes V Třída serie V-klase 08/2005->10/2014

Elektropřípojka
Wiring kit
Trekhaakkabelset
E-satz
Faisceau D'attelage
Barra de remolque
Wiązka elektryczna
Vetokoukun vaijerisarja
Гачковий джгут



výrobce / dodavatel

SVC Group s.r.o.

Odkaz na produkt:

<https://www.svcgroup.cz/tazne-zarizeni-sro-uby-pevny-skoda-rapid-monte-carlo-10-2012-2018-p7283-v960>



www.svcgroup.cz

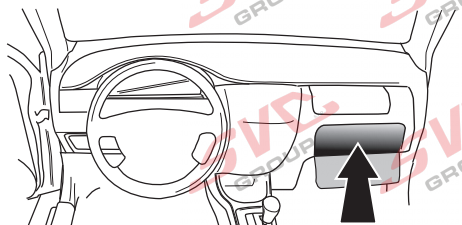

- DE Gebrauchsanleitung
- FR Mode d'emploi
- NL Gebruikershandleiding
- GB User guide
- ES Guía del usuario
- IT Manuale di istruzioni
- SE Bruksanvisning
- CZ Uživatelská příručka
- DK Brugervejledning
- FI Käyttöohjeet
- GR Οδηγός χρήστη
- NO Brukerveiledning
- PL Instrukcja obsługi

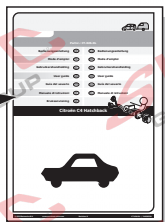

Partnr.: MB-070-D1

- | | | | |
|-----------------------|----|----|----------------------|
| Gebrauchsanleitung | DE | CZ | Uživatelská příručka |
| Mode d'emploi | FR | DK | Brugervejledning |
| Gebruikershandleiding | NL | FI | Käyttöohjeet |
| User guide | GB | GR | Οδηγός χρήστη |
| Guía del usuario | ES | NO | Brukerveiledning |
| Manuale di istruzioni | IT | PL | Instrukcja obsługi |
| Bruksanvisning | SE | | |

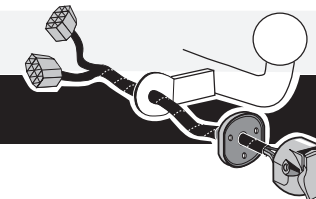

Mercedes Vito / Viano 08/2005-

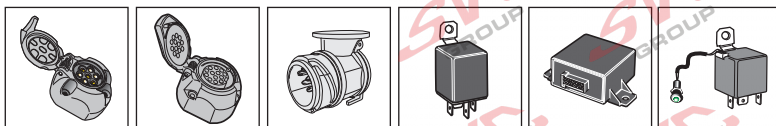

SPARE PARTS

www.ecs-electronics.com

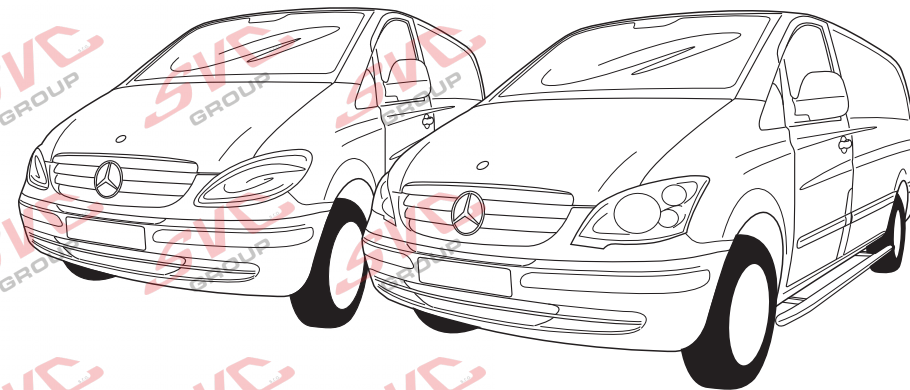

- Anschluss Steckdose
- Connection de la prise
- Contactdoos aansluiting
- Socket connection
- Conexión de la caja de enchufe
- Allaccio zoccolo
- Anslutning kontaktdosa
- Objímkový konektor
- Stikdåse forbindele
- Pistorasias liitäntä
- Υποδοχή σύνδεσης
- Tilkobling koblingsboks
- Połączenie przez gniazdo

DIN/ISO 11446	↩		1-8			7/58-L		8		9	10	11	12	13	9
P.max	1/L 21W	2 2x21W	3/31	4/R 21W	5/58-R 52W	6/54 3x21W	7/58-L 52W	8 2x21W	9 180W/15Amp	10 180W/15Amp	11 180W/15Amp	12	13	9	
	Gelb	Blau	Weiß	Grün	Braun	Rot (1,00mm ²)	Schwarz	Schwarz/ Rot	Braun/ Weiß	Rot (2,50mm ²)	Weiß	Weiß	-	Weiß	
	Jaune	Bleu	Blanc	Vert	Marron	Rouge (1,00mm ²)	Noir	Noir/ Rouge	Marron/ Blanc	Rouge (2,50mm ²)	Blanc	Blanc	-	Blanc	
	Geel	Blauw	Wit	Groen	Bruin	Rood (1,00mm ²)	Zwart	Zwart/ Rood	Bruin/ Wit	Rood (2,50mm ²)	Wit	Wit	-	Wit	
	Yellow	Blue	White	Green	Brown	Red (1,00mm ²)	Black	Black/ Red	Brown/ White	Red (2,50mm ²)	White	White	-	White	
	Amarillo	Azul	Blanco	Verde	Marrón	Rojo (1,00mm ²)	Negro	Negro/ Rojo	Marrón/ Blanco	Rojo (2,50mm ²)	Blanco	Blanco	-	Blanco	
	Giallo	Blu	Bianco	Verde	Marrone	Rosso (1,00mm ²)	Nero	Nero/ Rosso	Marrone/ Bianco	Rosso (2,50mm ²)	Bianco	Bianco	-	Bianco	
	Gul	Blå	Vit	Grön	Brun	Röd (1,00mm ²)	Svart	Svart/ Röd	Brun/ Vit	Röd (2,50mm ²)	Vit	Vit	-	Vit	
	Žlutá	Modrá	Bílá	Zelená	Hnědá	Červená (1,00mm ²)	Černá	Černo/ Červená	Hnědo/ Bílá	Červená (2,50mm ²)	Bílá	Bílá	-	Bílá	
	Gul	Blå	Hvid	Grøn	Brun	Rød (1,00mm ²)	Sort	Sort/ Rød	Brun/ Hvid	Rød (2,50mm ²)	Hvid	Hvid	-	Hvid	
	Keltainen	Sininen	Valkoinen	Vihreä	Ruskea	Punainen (1,00mm ²)	Musta	Musta/ Punainen	Ruskea/ Valkoinen	Punainen (2,50mm ²)	Valkoinen	Valkoinen	-	Valkoinen	
	Κίτρινο	Μπλε	Λευκό	Πράσινο	Καφέ	Κόκκινο (1,00mm ²)	Μαύο	Μαύο/ Κόκκινο	Καφέ/ Λευκό	Κόκκινο (2,50mm ²)	Λευκό	Λευκό	-	Λευκό	
	Gul	Blå	Hvit	Grønn	Brun	Rød (1,00mm ²)	Svart	Svart/ Rød	Brun/ Hvit	Rød (2,50mm ²)	Hvit	Hvit	-	Hvit	
	Żółty	Niebieski	Biały	Zielony	Brazowy	Czerwony (1,00mm ²)	Czarny	Czarny/ Czerwony	Brazowy/ Biały	Czerwony (2,50mm ²)	Biały	Biały	-	Biały	

- | | | | |
|------------------------------|----------------------------|-------------------------------|----------------------------|
| (DE) Sicherungen austauschen | (ES) Cambio de fusible | (CZ) Výměna pojistky | (GR) Αλλαγή ασφάλειας |
| (FR) Remplacer les fusibles | (IT) Sostituire i fusibili | (DK) Udskiftning af sikringer | (NO) Skifte sikringene |
| (NL) Zekeringen vervangen | (SE) Byte av säkringar | (FI) Vaihtaa varokkeet | (PL) Wymienić bezpieczniki |
| (GB) Changing the fuse | | | |

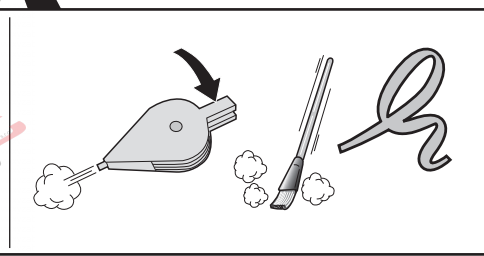
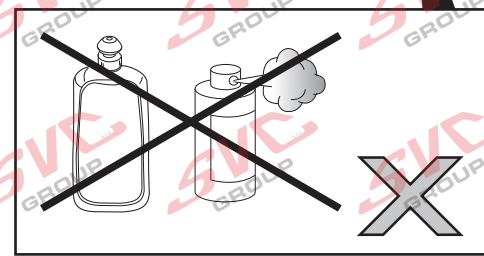
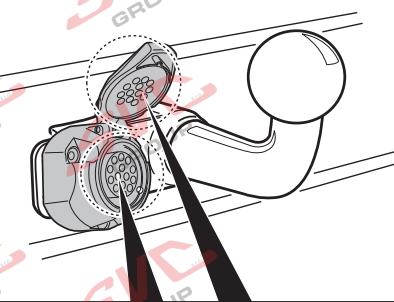
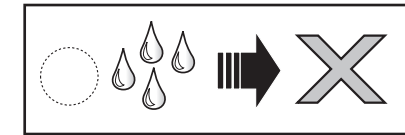
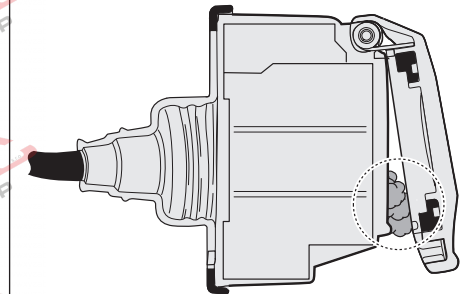
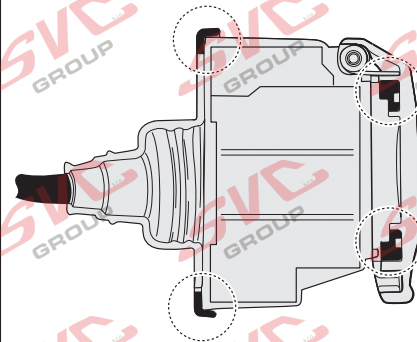
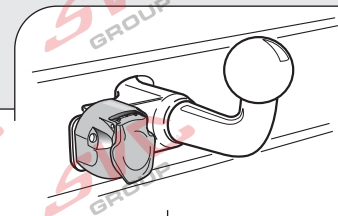
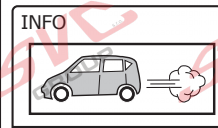
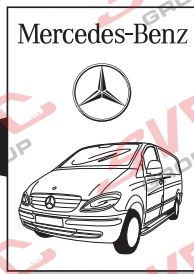
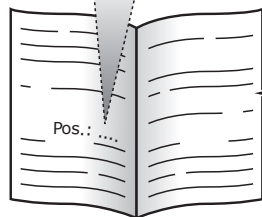
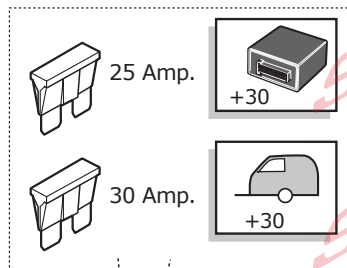

INFO : Ring.

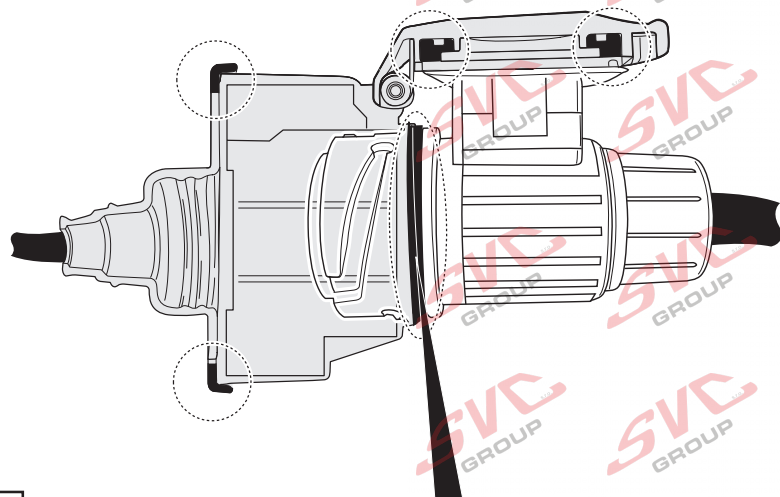
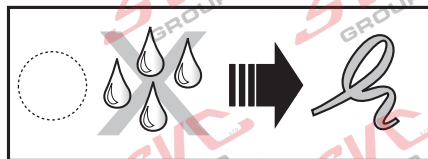
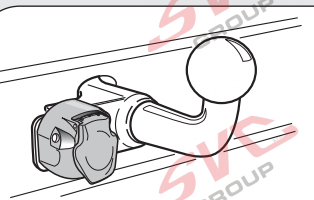
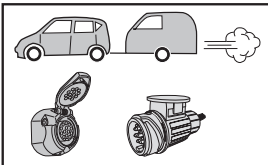

INFO

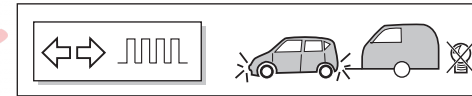
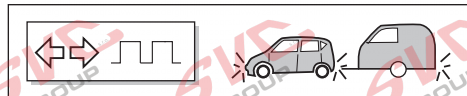
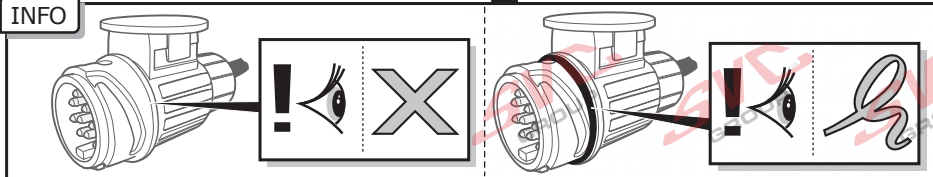

- (DU) Ein defektes Blinklicht an der Anhänger wird durch ein schnelleres Blinken der anderen Blinklichter angezeigt.
- (FR) Un clignotant défectueux de la remorque est signalé par le clignotement plus rapide des autres lampes clignotantes.
- (NL) Een defekt knipperlicht van de aanhanger wordt aangegeven door het versneld knipperen van de overige knipperlichten.
- (GB) A defective indicator of the trailer is stated by a quicker flashing of the other indicator lights.
- (ES) Una luz de destellos defectuosa en vehículos con o sin remolque se indica mediante el parpadeo rápido de las restantes luces de destellos.
- (IT) Un indicatore di direzione difettoso del rimorchio viene indicato dal lampeggiare più rapido degli altri indicatori di direzione.
- (SE) En trasig blinkerlampa anges genom att de övriga blinkljusen blinkar snabbt.
- (CZ) Vadné směrové světlo přívěs je signalizováno rychlejším blikáním dalšího směrového světla.
- (DK) Hvis der findes et defekt indikatorlys i anhængerens vises det ved at det andet indikatorlys blinker hurtigere.
- (FI) Viallisesta vilkkuvalmista ilmaistaan siten, että muut vilkkuvalot vilkkuvat nopeammin.
- (GR) Ο ελαττωματικός λαμπτήρας των φλας του αυτοκινήτου ή/και του ρυμουλκού υποδηλώνεται από ένα πιο γρήγορο αναβόσβημα του άλλου λαμπτήρα των φλας.
- (NO) Et defekt blinklys vises ved at de øvrige blinklysene blinker raskt.
- (PL) Uszkodzone światło wskaźnika w przyczepa jest sygnalizowane przez szybsze pulsowanie drugiego wskaźnika.



PARK DISTANCE CONTROL



PARK DISTANCE CONTROL

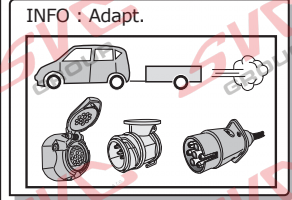
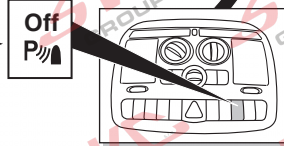
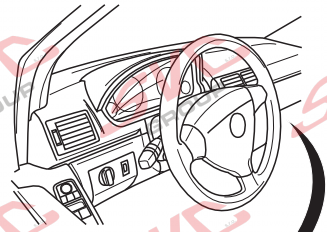

INFO : Adapt.

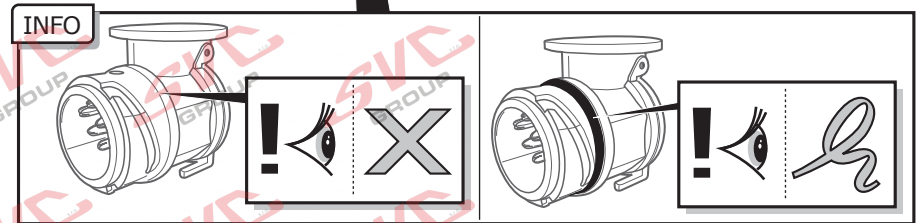
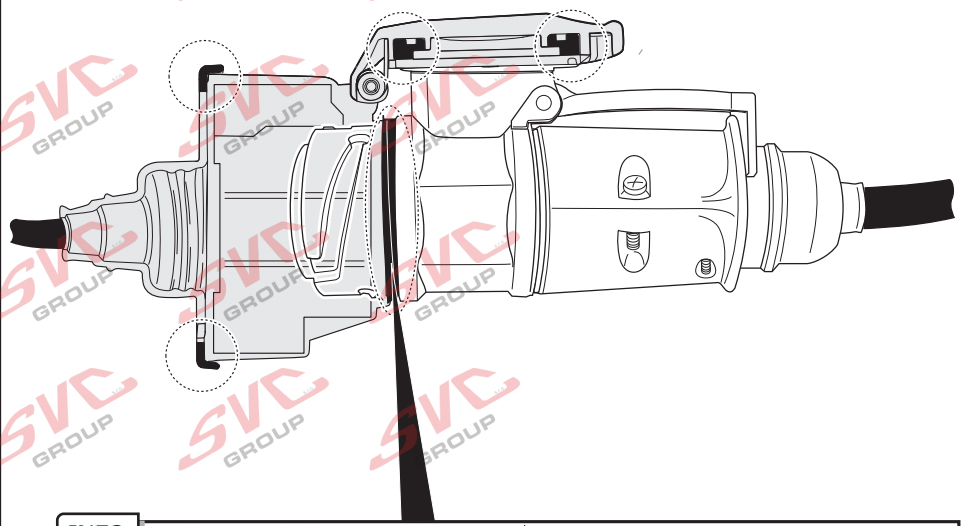
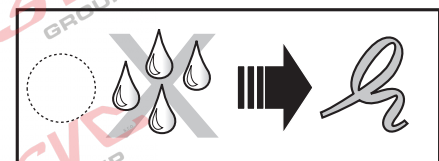
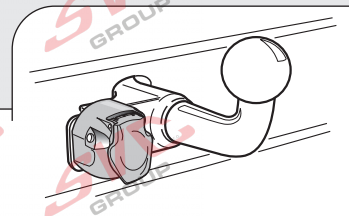

INFO

INFO : Storage

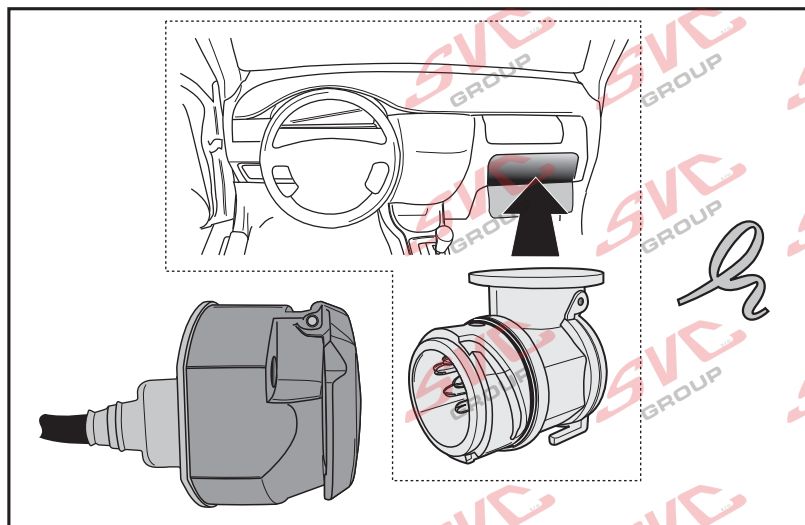
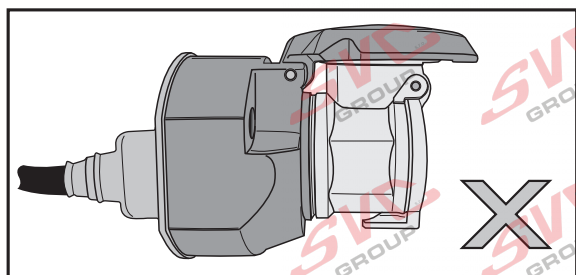
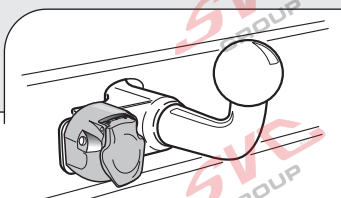
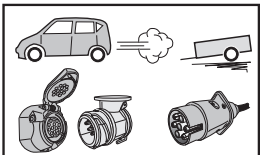

- (DE) Falls zutreffend soll bei einem angekoppelten Anhänger mit einer Nebelleuchte in Betrieb die Nebelleuchte des Fahrzeugs ausgeschaltet werden.
- (FR) Le cas échéant, lorsqu'une remorque, avec des anti-brouillard actifs, est branchée, les anti-brouillards du véhicule seront déconnectés.
- (NL) Indien van toepassing zal bij een gekoppelde aanhanger met een werkende mistlamp de mistlamp van het voertuig worden uitgeschakeld.
- (GB) In a coupled trailer with working fog lamp, the fog lamp of the vehicle will be switched off, if applicable.
- (ES) En un remolque acoplado con faros antiniebla en funcionamiento, se apagarán, si es aplicable, los faros antiniebla del vehículo.
- (IT) Se applicabile, in presenza di un rimorchio agganciato con una luce antinebbia in funzione, l'antinebbia del veicolo viene disinserito.
- (SE) Om tillämpligt kopplas ett fungerande dimljus bort från det anslutna släpet.
- (CZ) Pokud je na připojeném přívěsu zapnuta mlhovka, bude tato mlhovka na přívěsu vypnuta.
- (DK) Hvis det er relevant, vil på en tilkoblet anhænger med en fungerende tågelygte vognens tågelygte frakobles.
- (FI) Jos liitetyssä perävaunussa on toimiva sumuvalo, ajoneuvon sumuvalo kytketään pois päältä.
- (GR) Σε συζευγμένο ρυμουλκό στο οποίο λειτουργεί φανός ομίχλης, ο φανός ομίχλης του οχήματος θα απενεργοποιηθεί, εφόσον ενδείκνυται.
- (NO) Om nødvendig skal kjøretøyets tåkelys slås av, dersom tilhengeren som kobles til selv har et fungerende tåkelys.
- (PL) W stosownych przypadkach, przy przyłączonej przyczepie z działającymi światłami przeciwmgielnymi, zostaną wyłączone światła przeciwmgielne pojazdu.

Nevíte si rady? Potřebujete poradit?

Náš zákaznický servis je vám k dispozici

 +420 491 421 021

 svc@svcgroup.cz



Opravdový specialista a Certifikovaný výrobce tažných zařízení s největším sortimentem v ČR. Rodinná firma s více jak 30letou ověřenou tradicí výroby, prodeje a montáže.

www.svcgroup.cz