

# Montážní návod

(Montážny návod, Fitting instruction, Montageanleitung,  
Istruzioni di montaggio, Monteringshandledning,  
Asennusohje, Instruction de montage,  
Montegehandleiding, Инструкция по установке)



## Elektropřípojka

Nissan X-Trail 07/2007->02/2014

Elektropřípojka  
Wiring kit  
Trekhaakkabelset  
E-satz  
Faisceau D'attelage  
Barra de remolque  
Wiązka elektryczna  
Vetokoukun vaijerisarja  
Гачковий джгут



výrobce / dodavatel

**SVC Group s.r.o.**

Odkaz na produkt:

<https://www.svcgroup.cz/tazne-zarizeni-sro-uby-pevny-skoda-rapid-monte-carlo-10-2012-2018-p7283-v960>



[www.svcgroup.cz](http://www.svcgroup.cz)

## ! INFO !

- (DE) Die Batterie des Zugfahrzeugs bzw. gezogenen Fahrzeugs nicht direkt über die Steckdose aufladen.
- (FR) Ne pas charger les batteries du véhicule tracteur et/ou tracté directement sur la prise de courant.
- (NL) De accu van het trekkend voertuig c.q. getrokken voertuig niet rechtstreeks via de contactdoos opladen.
- (GB) Do not charge the battery of the towing vehicle and/or towed vehicle directly via the socket.
- (ES) No recargue la batería del vehículo remolque y/o del remolcado directamente mediante el enchufe.
- (IT) Non caricare la batteria del veicolo trainante o di quello trainato direttamente dalla presa.
- (SE) Ladda inte batteriet i det bogserande fordonet och/eller det bogserade fordonet direkt via kontakten.
- (CZ) Nenabíjajte baterii tažného ani taženého vozidla přes zásuvku.
- (DK) Oplad ikke bugseringskøretøjet og/eller det bugserede køretøjs batteri direkte v.h.a. stikkåsen.
- (FI) Älä lataa hinaavan ajoneuvon ja/tai hinattavan ajoneuvon akkua suoraan pistorasian kautta.
- (GR) Μη φορτίζετε την μπαταρία του ρυμουλκούμενου οχήματος και/ή ρυμουλκημένου οχήματος απευθείας μέσω του ρευματοδότη.
- (NO) Batteriet til kjøretøyet som trekker eller blir trukket skal ikke lades direkte via koblingsboksen.
- (PL) Nie ładować akumulatora pojazdu holującego/holowanego bezpośrednio przez gniazdo.

- (DE) Gebrauchsanleitung  
(FR) Mode d'emploi  
(NL) Gebruikershandleiding  
(GB) User guide  
(ES) Guía del usuario  
(IT) Manuale di istruzioni  
(SE) Bruksanvisning  
(CZ) Uživatelská příručka  
(DK) Brugervejledning  
(FI) Käyttöohjeet  
(GR) Οδηγός χρήστη  
(NO) Brukerveiledning  
(PL) Instrukcja obsługi

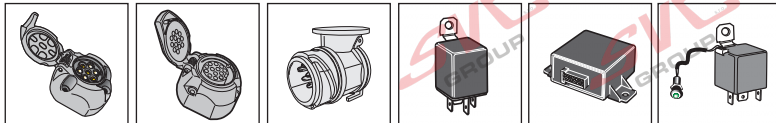
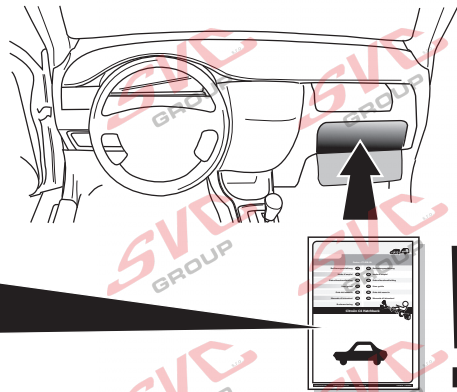

## SPARE PARTS

[www.ecs-electronics.com](http://www.ecs-electronics.com)



Partnr.: NI-041-BB

Gebrauchsanleitung (DE)

(CZ) Uživatelská příručka

Mode d'emploi (FR)

(DK) Brugervejledning

Gebruikershandleiding (NL)

(FI) Käyttöohjeet

User guide (GB)

(GR) Οδηγός χρήστη

Guía del usuario (ES)

(NO) Brukerveiledning

Manuale di istruzioni (IT)

(PL) Instrukcja obsługi



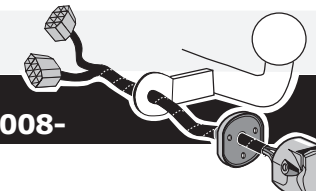



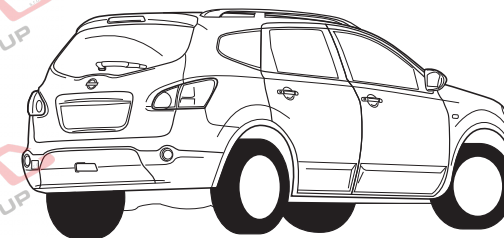
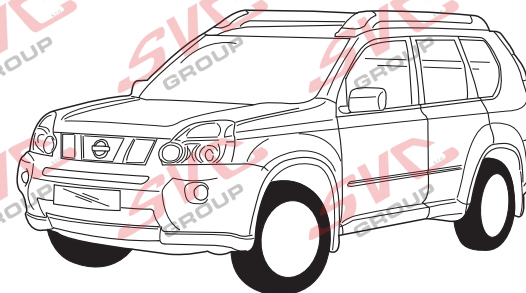

Bruksanvisning (SE)



Nissan X-trail 10/2007-  
Nissan Qashqai 2007- / Nissan Qashqai+2 2008-



- (DE) Anschluss Steckdose  
 (FR) Connection de la prise  
 (NL) Contactdoos aansluiting  
 (GB) Socket connection  
 (ES) Conexión de la caja de enchufe  
 (IT) Allaccio zoccolo  
 (SE) Anslutning kontaktdosa  
 (CZ) Objímkový konektor  
 (DK) Stikdåse forbindelse  
 (FI) Pistorasia liitântä  
 (GR) Υποδοχή σύνδεσης  
 (NO) Tilkobling koblingsboks  
 (PL) Połączenie przez gniazdo

DIN/ISO 1724								
Pmax	21W	2x21W			21W	52W	3x21W	52W
(DE)	Gelb	Blau	Grau	Weiß	Grün	Braun	Rot	Schwarz
(FR)	Jaune	Bleu	Gris	Blanc	Vert	Marron	Rouge	Noir
(NL)	Geel	Blauw	Grijs	Wit	Groen	Bruin	Rood	Zwart
(GB)	Yellow	Blue	Grey	White	Green	Brown	Red	Black
(ES)	Amarillo	Azul	Gris	Blanco	Verde	Marrón	Rojo	Negro
(IT)	Giallo	Blu	Grigio	Bianco	Verde	Marrone	Rosso	Nero
(SE)	Gul	Blå	Grå	Vit	Grön	Brun	Röd	Svart
(CZ)	Žlutá	Modrá	Šedá	Bílá	Zelená	Hnědá	Červená	Černá
(DK)	Gul	Blå	Grå	Hvid	Grøn	Brun	Rød	Sort
(FI)	Keltainen	Sininen	Harmaa	Valkoinen	Vihreä	Ruskea	Punainen	Musta
(GR)	Κίτρινο	Μπλε	Γκρι	Λευκό	Πράσινο	Καφέ	Κόκκινο	Μαύρο
(NO)	Gul	Blå	Grå	Hvit	Grønn	Brun	Rød	Svart
(PL)	Żółty	Niebieski	Szary	Biały	Zielony	Brązowy	Czerwony	Czarny

SVC GROUP

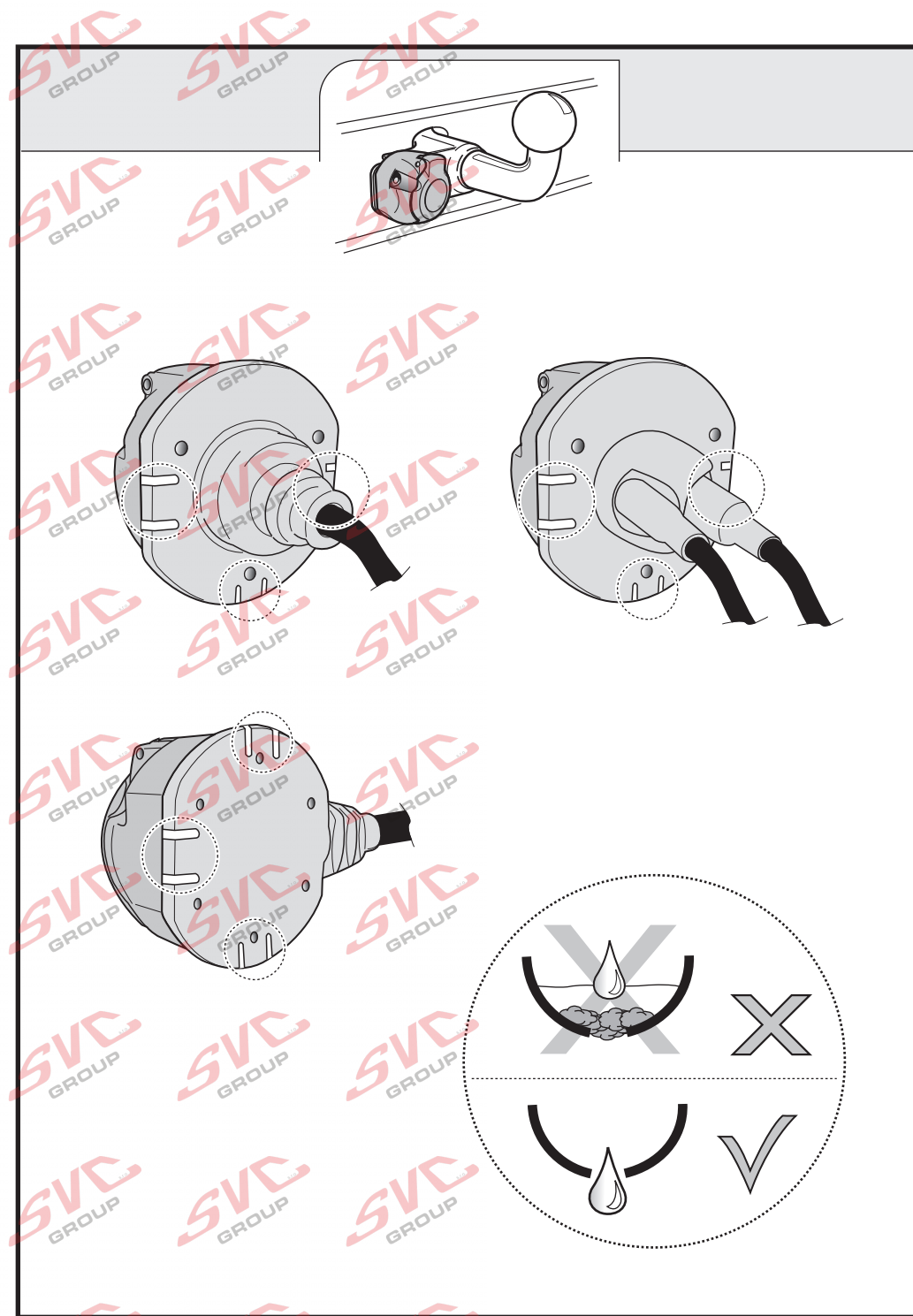

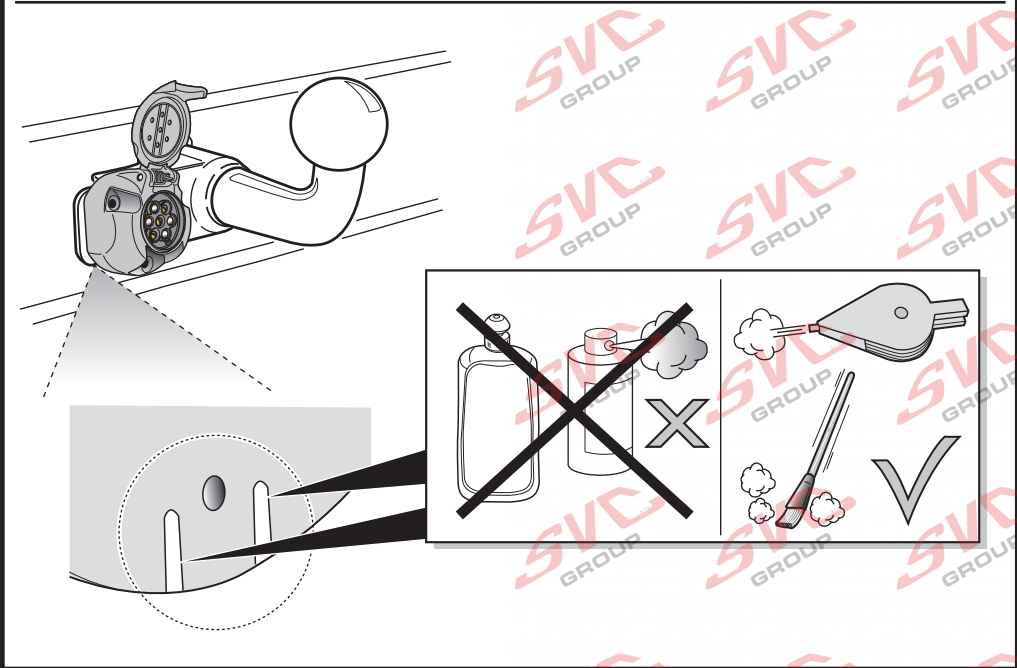
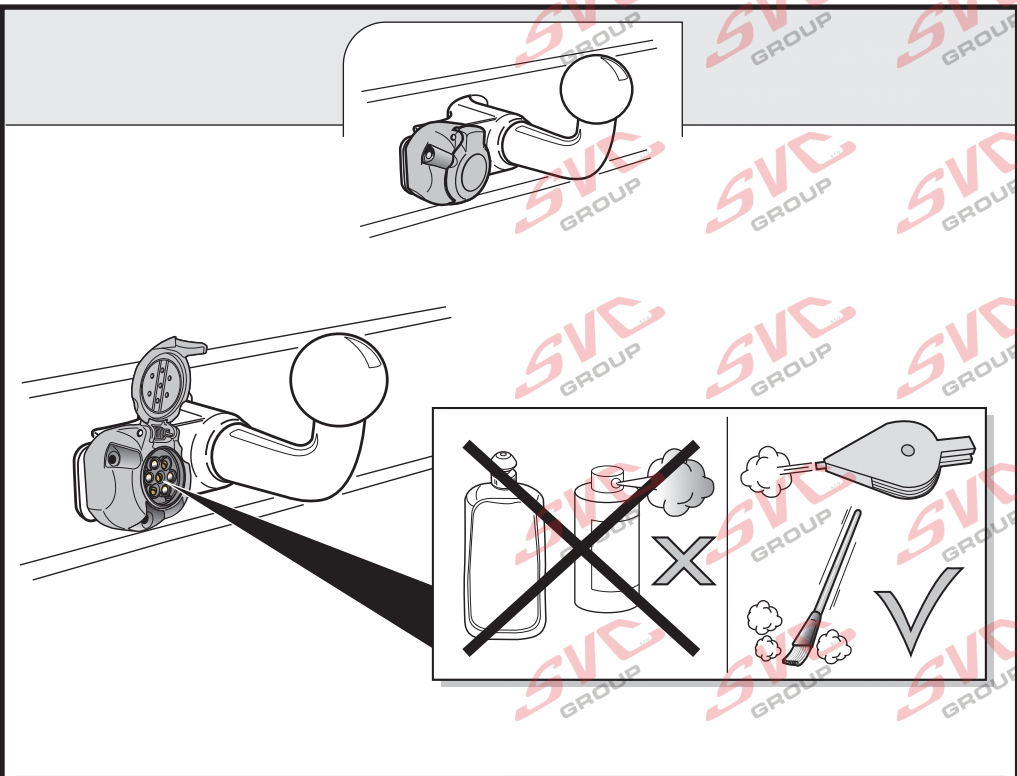

Nevíte si rady? Potřebujete poradit?

# Náš zákaznický servis je vám k dispozici

 +420 491 421 021

 [svc@svcgroup.cz](mailto:svc@svcgroup.cz)



Opravdový specialista a Certifikovaný výrobce tažných zařízení s největším sortimentem v ČR. Rodinná firma s více jak 30letou ověřenou tradicí výroby, prodeje a montáže.

[www.svcgroup.cz](http://www.svcgroup.cz)