

Tažné zařízení TOYOTA COROLLA CROSS

Original SVC GROUP s.r.o.

09/2022->



Tažné zařízení
Anhängervorrichtungen
Attelages
TOWBARS

SVC GROUP s.r.o.

Vysokov 179, 547 01 Náchod, Česká Republika



www.svcgroup.cz



Katalogové číslo / Catalogue number / Katalognummer / Numero di catalogo:

VTZ 001-532

VTZ 002-532

VTZ 003-532

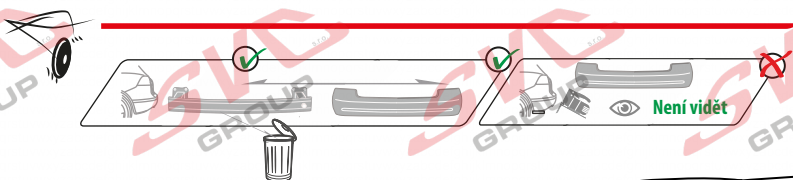

Není vidět

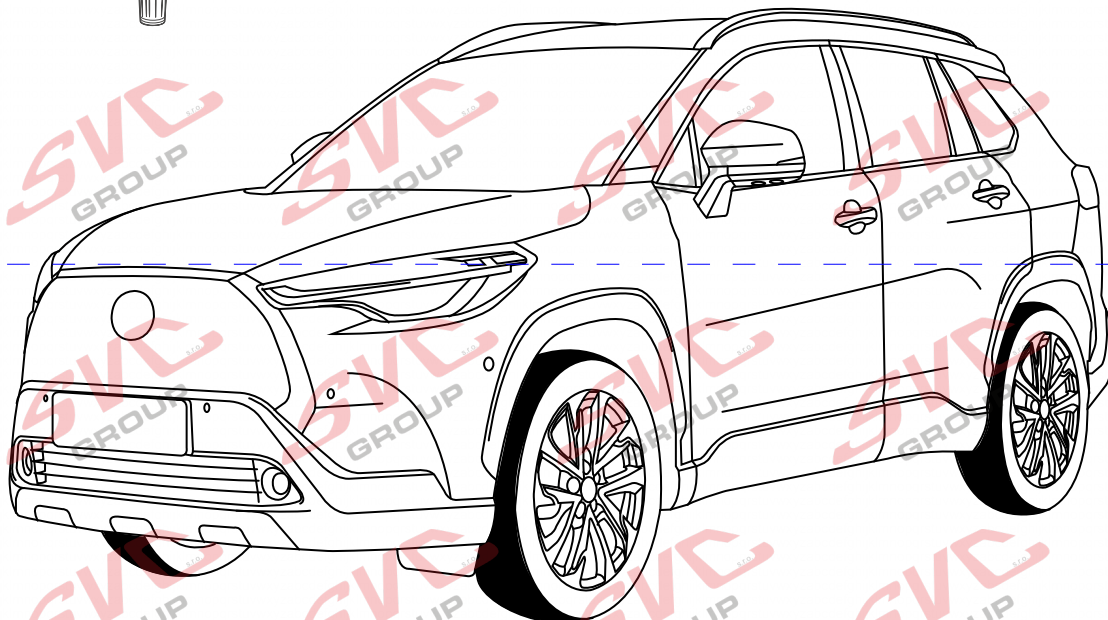

5-10 min



SCAN ME



CZ Pro podrobné montážní instrukce a podmínky výrobku si naskenujte QR kód
SK Pre podrobné montážne pokyny a podmienky produktu si môžete skenovať QR kód
GB For detailed installation instructions and product conditions, scan the QR code
DE Scannen Sie den QR-Code, um detaillierte Installationsanweisungen und Produktbedingungen zu erhalten
FR Pour des instructions d'installation détaillées et les conditions du produit, scannez le code QR
ITA Per istruzioni di installazione dettagliate e condizioni del prodotto, eseguire la scansione del codice QR
PL Aby uzyskać szczegółowe instrukcje dotyczące instalacji i warunki produktu, zeskanuj kod QR
SP Para obtener instrucciones detalladas de instalación y condiciones del producto, escanee el código QR
NL Voor gedetailleerde installatie-instructies en productvoorwaarden, scan de QR-code
FIN Tarkemmat asennusohjeet ja tuotteen ehdot on tarkistettava QR-koodilla
HU A részletes telepítési utasítások és a termék feltételei között olvassa el a QR kódot
SLO Za podrobna navodila za namestitvev in pogoje izdelka skenirajte kodo QR
RU Подробные инструкции по установке и условиям продукта отсканируйте QR-код.

e-mail: svc@scvgroup.cz Tel.: +420 491421021 +420 491421022 mob.: +420 603360607

© SVC GROUP s.r.o.



55R-01-0640

A-20/6013V3



VTZ 001-532

A-532-2024



VTZ 002-532

A-532-2024



VTZ 003-532

AV-532-2024



1400/95=7,80



2->2,5 h



M12x40 G10.9 4x

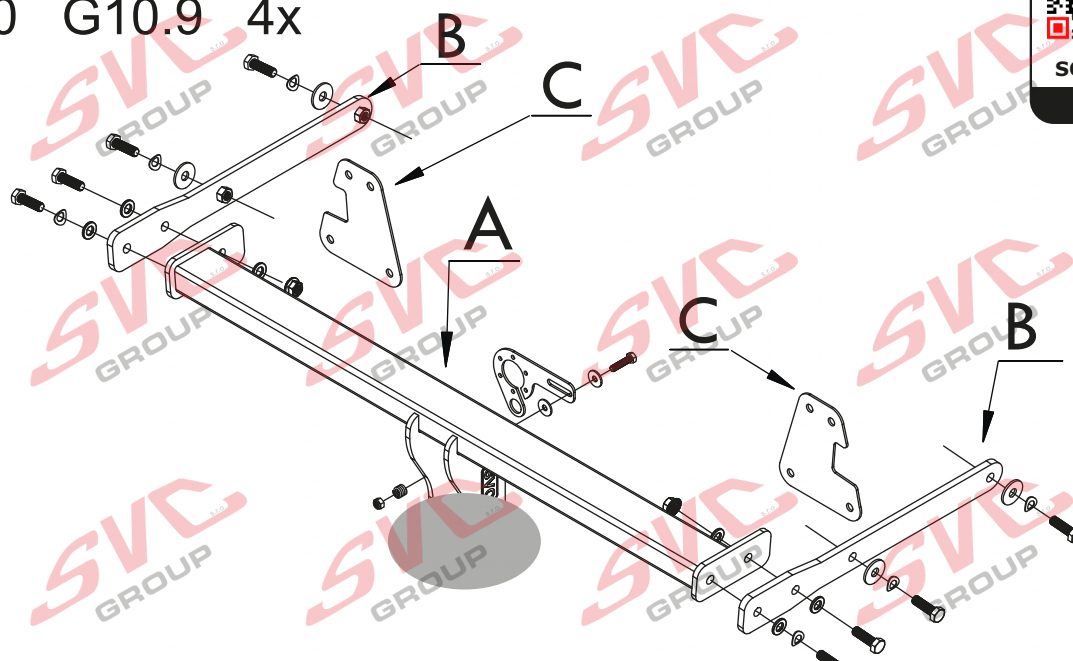

M12x40 G10.9 4x

	A	x1		M12x40 G10.9	8ks
	B	x2		Ø12	6ks
	C	x2		Ø12	6ks
				Ø12	4ks
				M12	2ks
Dlouhé					





TOYOTA COROLLA CROSS 09/2021-



Montážní návod
Montážny návod
Installation instructions
Installationsanleitung
Instructions d'installation
Инструкция по установке

55R-01-0640



VTZ 001-532



VTZ 002-532



VTZ 003-532

95

1 400

D= 7,80



kN

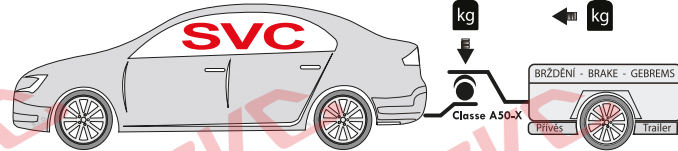

1,5->2,0 h



2->2,5 h

M12x40 G10.9 4x

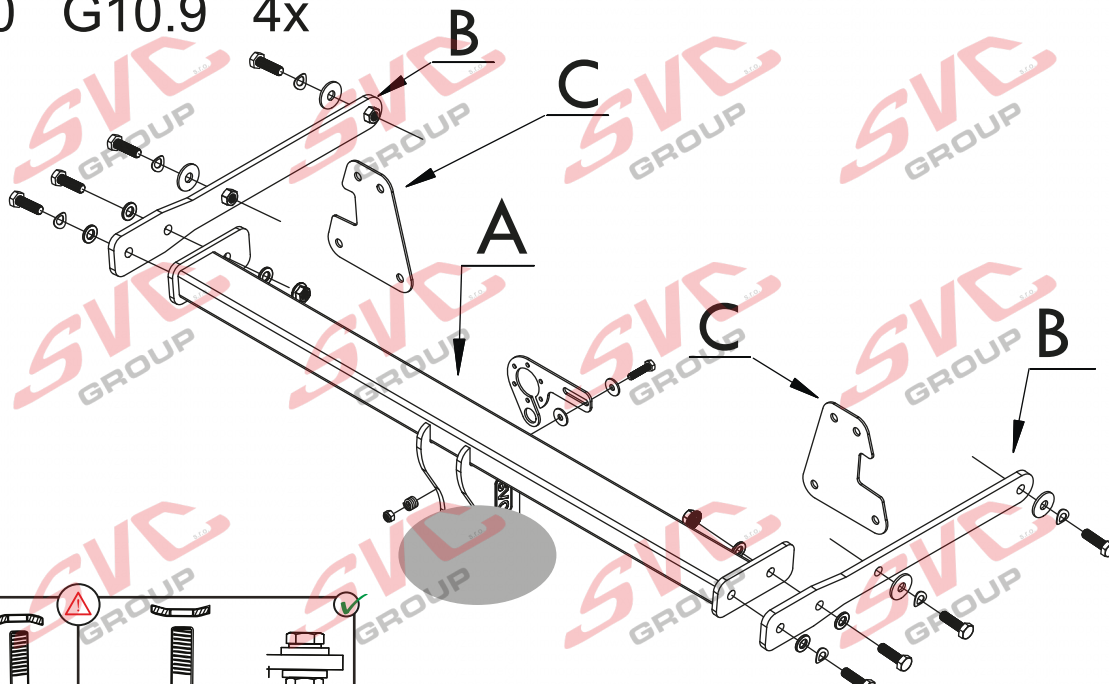

M12x40 G10.9 4x

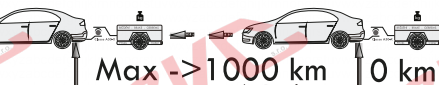
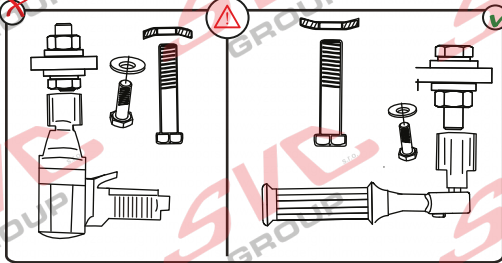

Pevnost	8,8	10,9	12,9
M6	9,7	14,3	16,1
M8	24,5	35,9	42,0
M10	48,4	71,0	83,0
M12	84,0	123,0	144,0
M14	133,0	196,0	229,0
M16	137,0	307,0	359,0



Nm



Homologace EHK 55-R



Approval Number Class **A50-X**

Exxx 00-xxxx

Type: _____ D-Value: _____ kN

Series: _____ Vert.Id: _____ kg

www.svcgroup.cz - CZECH REPUBLIC

- CZ Informace k provozu / homologaci
- SK Informácie na prevádzku / homologáciu
- EN Operating / homologation information
- DE Betriebs- / Zulassungsinformationen
- HU Üzemeltetési / homologációs információk
- FR Informations d'exploitation / homologatio
- IT Informazioni sull'operazione / omologazio
- NL Monteringsanvisningar
- ES Instrucciones de montaje
- FIN Montage-instructie
- SV Asennusohjeet
- NOR Drifts- / homologasjonsinformasjon
- PL Informacje dotyczące pracy / homologacji
- RU Информация о работе / омологации



SVC GROUP s.r.o. Průmyslová zóna - 179 547 01 Náchod-ČR

www.svcgroup.cz e-mail: svc@svcgroup.cz

Tel.: +420 491 421 021 +420 491 421 022 mob.: +420 603 360 607

QR kódem si stáhnete si rozšířený montážní návod / Mit QR-Code können Sie die erweiterte Montageanleitung herunterladen

SVC GROUP ©- 05/19

**CS Montážní návod**

Pro podrobné montážní instrukce a podmínky výrobu si naskenujte QR kód

1. Odmontujte zadní nárazník a jeho plechovou vyztuhu (tato nebude již zapotřebí). Odlepte krycí vrstvu z úchytných bodů na nosnicích.
2. Odzadu vsuňte pravý a levý bok tažného zařízení a přichyťte šrouby M12x40 (10.9) přes velkoplošné předložky (nedotahovat).
3. Mezi takto připravené boky namontujte hlavní nosník tažného zařízení šrouby M12x40 (10.9). Poté vše vyrovnejte a dotáhněte dle utahovacích momentů.
4. Zhotovte výřez nárazníku dle obrázku a namontujte zpět všechny díly odmontované v bodě číslo 1.

EN Installation instructions

For detailed installation instructions and product conditions, scan the QR code

1. Remove the rear bumper and its sheet metal reinforcement (this will no longer be needed). Peel the covering from the attachment points on the beams.
2. Insert the right and left sides of the towing bracket from the rear and attach the M12x40 screws (10.9) through the large tabs (do not tighten).
3. Install the main towing bracket between the sides prepared in this way with M12x40 (10.9) screws. Then align and tighten according to the tightening torques.
4. Make the cut-out of the bumper as shown and reinstall all the parts removed in step 1.

SK Montážny návod

Pre podrobné montážne pokyny a podmienky produktu si môžete skenovať QR kód

1. Odstranite zadnji odbijač in njegovo pločevinasto ojačitev (ta ne bo več potrebna). S pritrdilnih točk na nosilcih odlepite prevleko.
2. Z zadnje strani vstavite desno in levo stran nosilca za vleko in skozi velike jezičke pritrdite vijake M12x40 (10.9) (ne zategujte).
3. Glavni nosilec za vleko namestite med tako pripravljene stranice z vijaki M12x40 (10.9). Nato jih poravnajte in zategnite v skladu z zategovalnimi momenti.
4. Na odbijaču naredite izrez, kot je prikazano, in ponovno namestite vse dele, odstranjene v 1. koraku.

DE Montageanleitung

Scannen Sie den QR-Code, um detaillierte Installationsanweisungen und Produktbedingungen zu erhalten

1. entfernen Sie den hinteren Stoßfänger und seine Blechverstärkung (diese wird nicht mehr benötigt). Ziehen Sie die Abdeckung von den Befestigungspunkten an den Trägern ab.
2. Setzen Sie die rechte und linke Seite der Anhängervorrichtung von hinten ein und befestigen Sie die Schrauben M12x40 (10.9) durch die großen Laschen (nicht festziehen).
3. Montieren Sie die Hauptzugvorrichtung zwischen den so vorbereiteten Seiten mit M12x40 (10.9) Schrauben. Anschließend ausrichten und gemäß den Anzugsdrehmomenten festziehen.
4. Den Ausschnitt des Stoßfängers wie gezeigt anfertigen und alle in Schritt 1 entfernten Teile wieder einbauen.

PL Instrukcja montażu

Aby uzyskać szczegółowe instrukcje instalacji i warunki produktu, zeskanuj kod QR

1. Zdemontować tylny zderzak i jego blaszane wzmocnienie (nie będzie już potrzebne). Zdejmij osłonę z punktów mocowania na belkach.
2. Włożyć prawą i lewą stronę haka holowniczego od tyłu i przykręcić śruby M12x40 (10.9) przez duże zaczepy (nie dokręcać).
3. Zamontować główny wspornik holowniczy między tak przygotowanymi bokami za pomocą śrub M12x40 (10.9). Następnie wyrównaj i dokręć zgodnie z momentami dokręcania.
4. Wykonaj wycięcie w zderzaku, jak pokazano na rysunku i ponownie zamontuj wszystkie części zdemontowane w kroku 1.

FR Notice de montage

Pour des instructions d'installation détaillées et les conditions du produit, scannez le code QR

1. Retirer le pare-chocs arrière et son renfort en tôle (il ne sera plus nécessaire). Décollez le revêtement des points de fixation sur les poutres.
2. Insérer les côtés droit et gauche du support d'attelage par l'arrière et fixer les vis M12x40 (10.9) à travers les grandes pattes (ne pas serrer).
3. Installer le support de remorquage principal entre les côtés préparés de cette manière avec des vis M12x40 (10.9). Ensuite, alignez et serrez selon les couples de serrage.
4. Découpez le pare-chocs comme indiqué et réinstallez toutes les pièces retirées à l'étape 1.

FI Asennusohje

Tarkemmat asennusohjeet ja tuotteen ehdot on tarkistettava QR-koodilla

1. Irrota takapuskuri ja sen peltilevyvahvike (tätä ei enää tarvita). Kuori verhoilu palkkien kiinnityskohdista.
2. Aseta vetokoukun oikean- ja vasemmanpuoleinen kiinnike taaksepäin ja kiinnitä M12x40-ruuvit (10.9) suurten kielekkeiden läpi (älä kiristä).
3. Asenna päähinauskiinnike näin valmisteltujen sivujen väliin M12x40 (10.9) -ruuveilla. Kohdista ja kiristä sitten kiristysmomenttien mukaisesti.
4. Tee puskuriin kuvan mukainen leikkaus ja asenna takaisin kaikki vaiheessa 1 irrotetut osat.



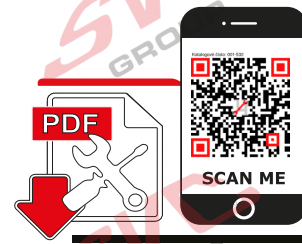
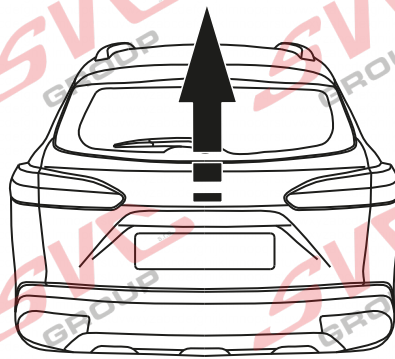

Montážní návod
Montážny návod
Installation instructions
Installationsanleitung
Instructions d'installation
Инструкция по установке

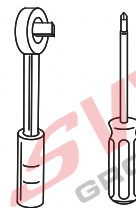
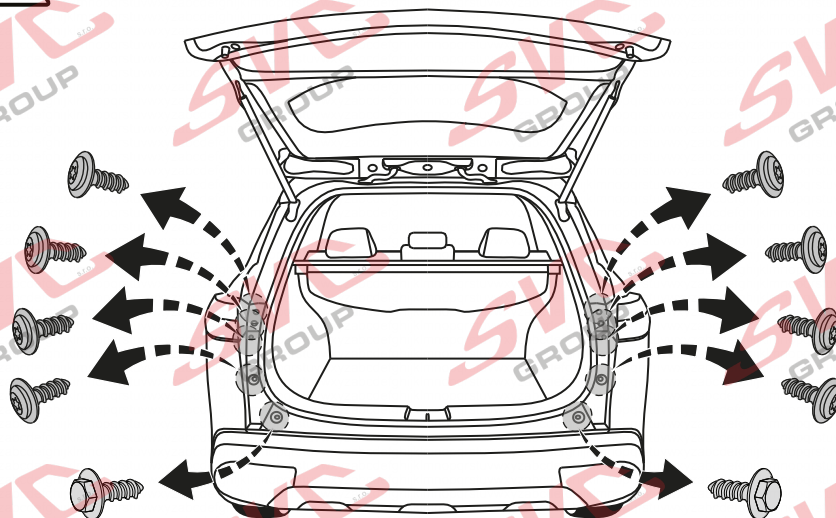

10 PH2

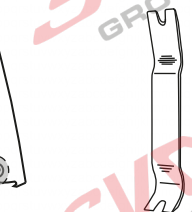
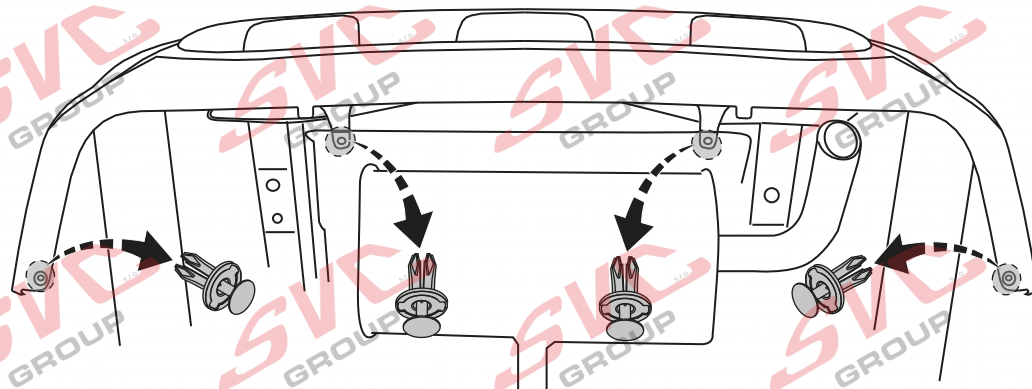
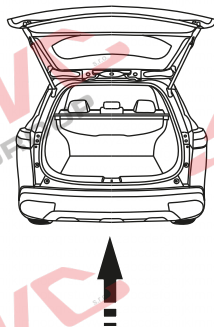
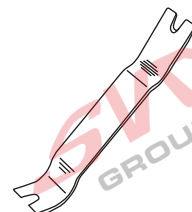
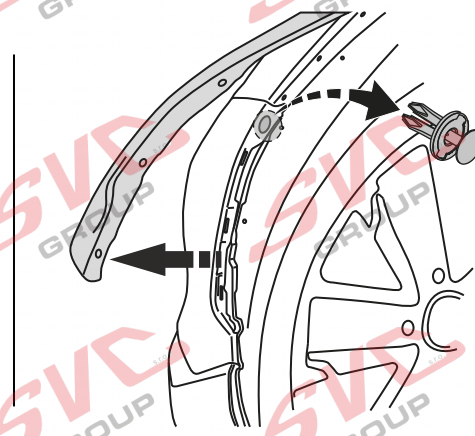
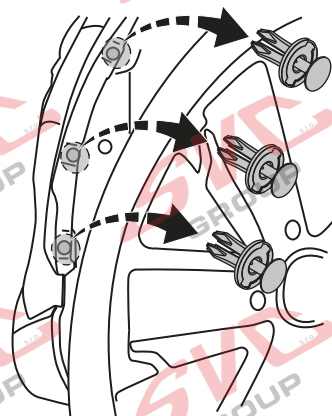
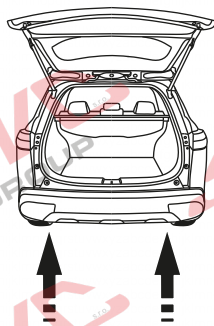

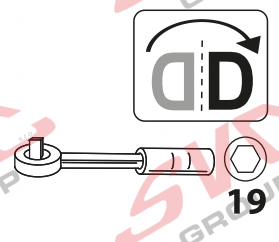
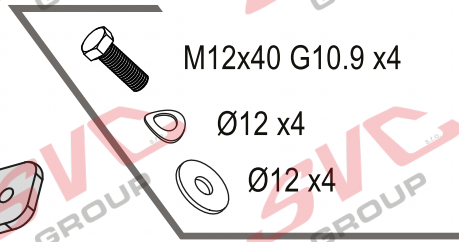
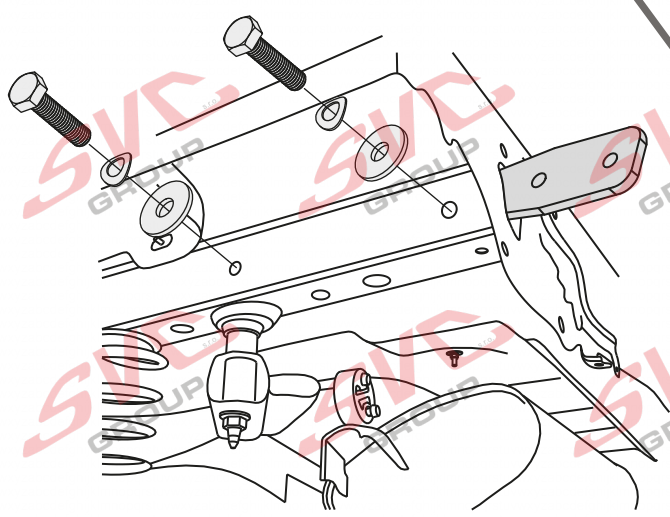
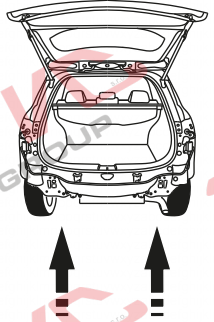
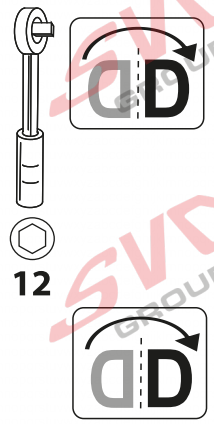
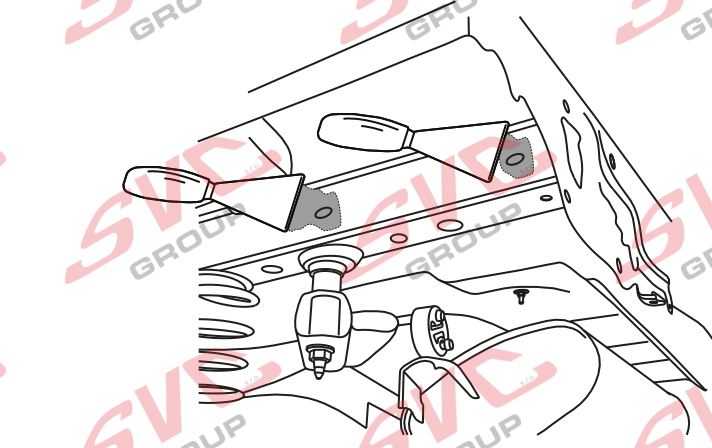
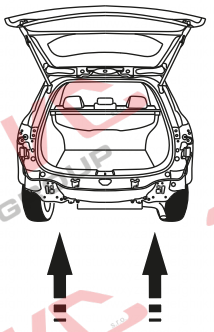
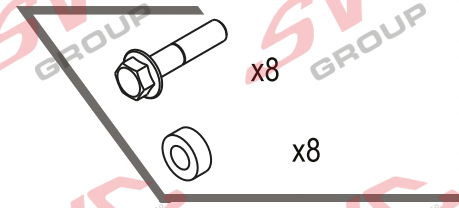
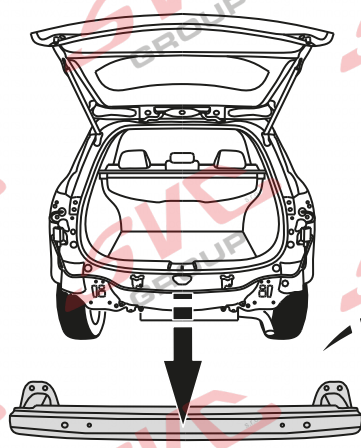
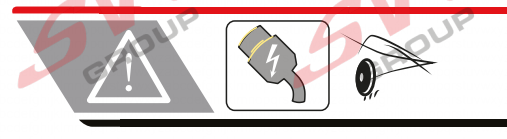
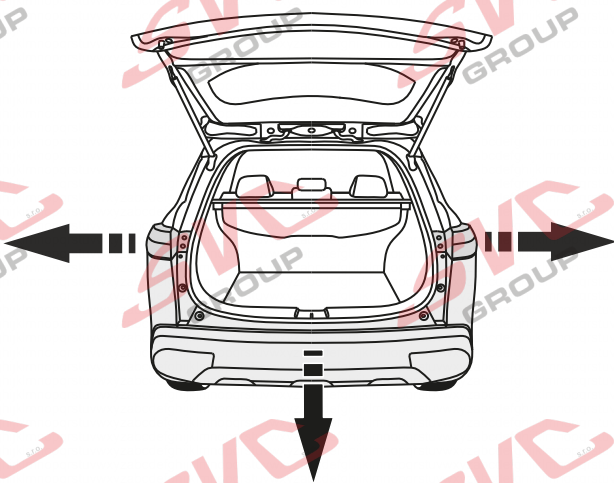

9.

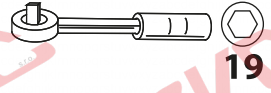
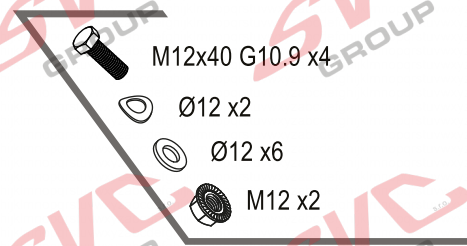
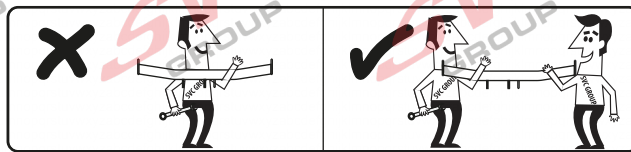
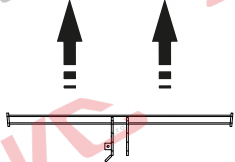
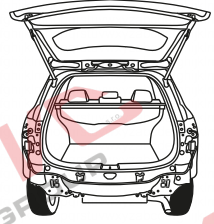

10.

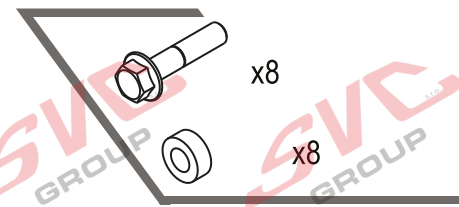
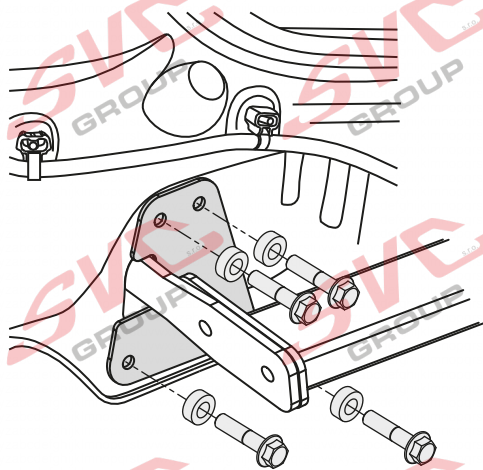
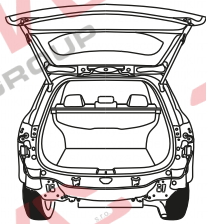

11.

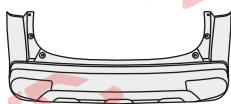

OSA VOZIDLA



SPODNÍ HRANA NÁRAZNÍKU



12.

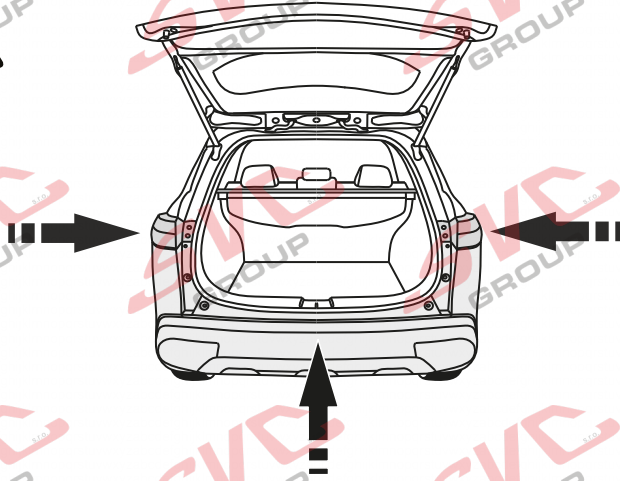

13.

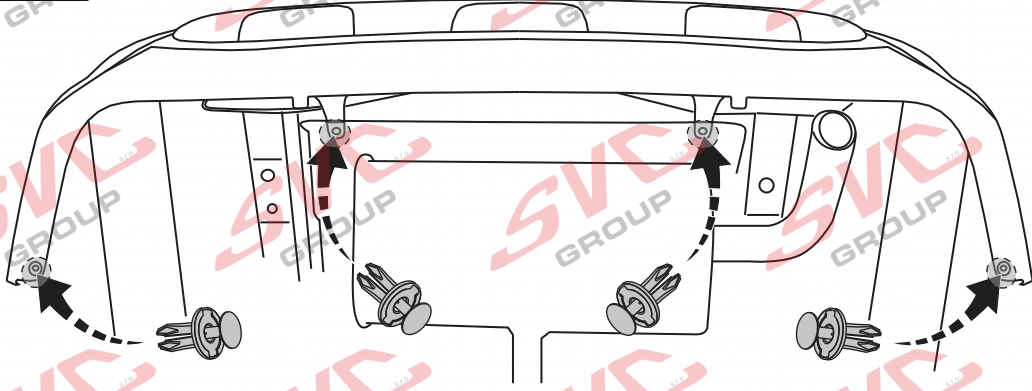
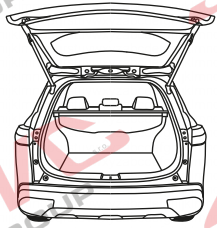

14.

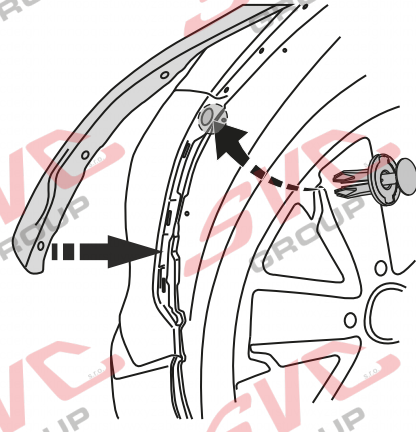
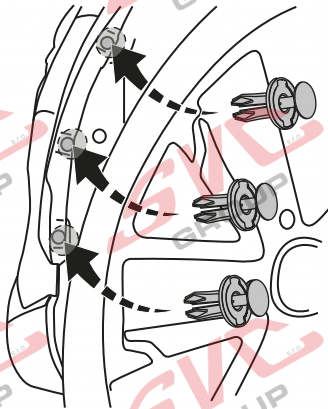
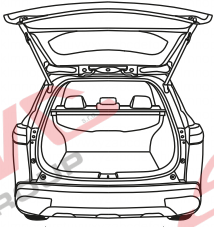

15.

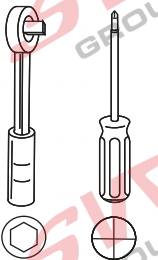
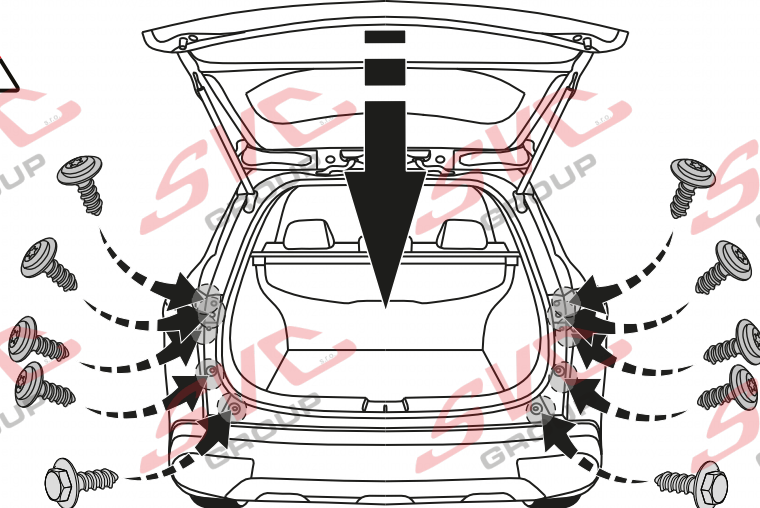

10 PH2



TOYOTA COROLLA CROSS 2021->

ŠABLONU PŘILOŽIT NA ČERNÝ PLAST
Z VENKU NÁRAZNÍKU

OSA VOZIDLA

1:1

SPODNÍ HRANA NÁRAZNÍKU

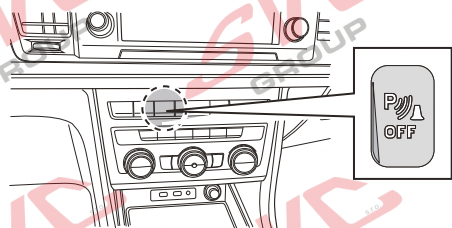
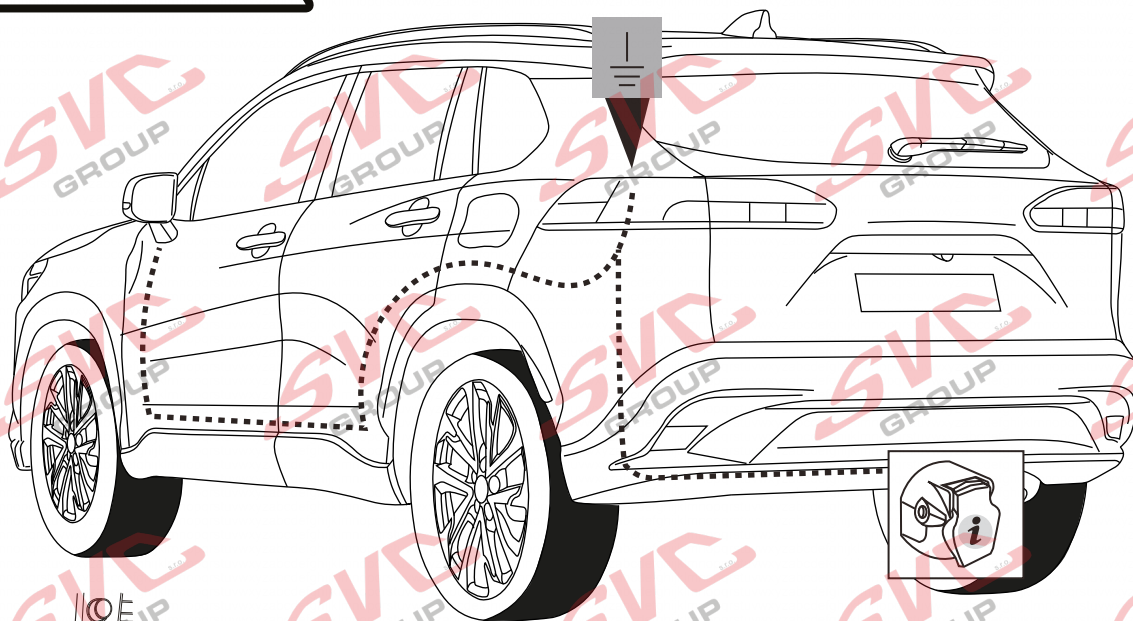

Informace pro odpojování couvacích senzorů PDC pro tažné zařízení

Vypínač pro vypínání couvacích senzorů PDC je umístěn na palubní desce vozu.

Nemusíte tedy pracně na elektro instalaci vozu napojovat odpojování couvacích senzorů PDC a zpětných kamer od elektro přípojky tažných zařízení.

Pokud chcete senzory vypnout, použijte vypínač na palubní desce.

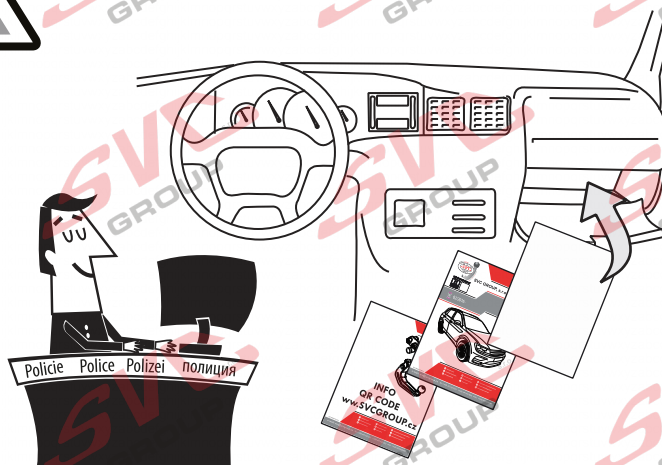

SVC GROUP

Děkuje za důvěru / Ďakuje za dôveru

Thank you for your trust / Danke Für dein Vertrauen

Merci pour votre conance / Grazie per la tua ducia

Tankewol foar jo fertrouwen / Спасибо за ваше доверие

Registrace / Registrácia

Registration / Registrierung

Inscription / Registrazione

Rekisteröinti / Регистрация



ES Manual de montaje Para obtener instrucciones detalladas de instalación y condiciones del producto, escanee el código QR

1. Retire el parachoques trasero y su refuerzo de chapa (ya no será necesario). Despegue el revestimiento de los puntos de fijación en los largueros.
2. Inserte los lados derecho e izquierdo del soporte de remolque desde la parte trasera y fije los tornillos M12x40 (10.9) a través de las lengüetas grandes (no apriete).
3. Instale el soporte de remolque principal entre los laterales preparados de esta manera con tornillos M12x40 (10.9). A continuación, alinee y apriete según los pares de apriete.
4. Haga el recorte del parachoques como se muestra en la figura y vuelva a instalar todas las piezas retiradas en el paso 1.

IT Istruzioni di montaggio per la Per istruzioni di installazione dettagliate e condizioni del prodotto, eseguire la scansione del codice QR

1. Rimuovere il paraurti posteriore e il suo rinforzo in lamiera (non sarà più necessario). Staccare il rivestimento dai punti di fissaggio sulle travi.
2. Inserire i lati destro e sinistro della staffa di traino dalla parte posteriore e fissare le viti M12x40 (10.9) attraverso le linguette grandi (non stringere).
3. Installare la staffa di traino principale tra i lati così preparati con viti M12x40 (10.9). Quindi allineare e serrare secondo le coppie di serraggio.
4. Eseguire il taglio del paraurti come illustrato e reinstallare tutte le parti rimosse al punto 1.

NO Monteringsanvisning For installasjonsinstruksjoner og produktbetingelser, skann QR-koden

1. Fjern den bakre støtfangeren og dens metallforsterkning (dette er ikke lenger nødvendig). Trekk av kledningen fra festepunktene på bjelkene.
2. Sett inn høyre og venstre side av tilhengerfestet bakfra og fest M12x40-skruene (10.9) gjennom de store tappene (ikke trekk til).
3. Monter hovedtilhengerfestet mellom sidene som er klargjort på denne måten, med M12x40-skruer (10.9). Juster og stram til i henhold til tiltrekkingsmomentene.
4. Gjør utskjæringen i støtfangeren som vist og monter alle delene som ble fjernet i trinn 1.

NL Montagehandleiding Scan de QR-code voor installatie-instructies en instructies voor productcondities

1. Verwijder de achterbumper en de plaatversteving (deze is niet meer nodig). Verwijder de bekleding van de bevestigingspunten op de balken.
2. Plaats de rechter- en linker kant van de trekhaak vanaf de achterkant en bevestig de M12x40 schroeven (10.9) door de grote lipjes (niet vastdraaien).
3. Installeer de hoofdtrekhaak tussen de op deze manier voorbereide zijanten met M12x40 (10.9) schroeven. Lijn vervolgens uit en draai vast volgens de aandraaimomenten.
4. Maak de uitsparing in de bumper zoals afgebeeld en monteer alle in stap 1 verwijderde onderdelen opnieuw.

HU Szerelési útmutató A telepítési és a termékfeltételekkel kapcsolatos utasításokat olvassa be a QR-kódot

1. Távolítsa el a hátsó lökhárítót és annak lemezmege erősítését (erre már nem lesz szükség). Húzza le a borítást a gerendák rögzítési pontjairól.
2. Helyezze be hátulról a vontatótartó jobb és bal oldalát, és a nagy fűlekre rögzítse az M12x40-es csavarokat (10.9) (ne húzza meg).
3. Szerelje be a fő vontatási konzolt az így előkészített oldalak közé az M12x40 (10.9) csavarokkal. Ezután igazítsa ki és húzza meg a meghúzási nyomatékoknak megfelelően.
4. Készítse el a lökhárító kivágását a képen látható módon, és szerelje vissza az 1. lépésben eltávolított összes alkatrészt.

RU Инструкция по монтажу Подробные инструкции по установке и условиям продукта отсканируйте QR-к

1. Снимите задний бампер и его усиление из листового металла (оно больше не понадобится). Снимите покрытие с мест крепления на балках.
2. Вставьте правую и левую стороны буксировочного кронштейна с задней стороны и закрепите винтами M12x40 (10.9) через большие выступы (не затягивайте).
3. Установите основной буксировочный кронштейн между подготовленными таким образом сторонами с помощью винтов M12x40 (10.9). Затем выровняйте и затяните в соответствии с моментами затяжки.
4. Сделайте вырез в бампере, как показано на рисунке, и установите все детали, снятые на шаге 1.





T-1

CZ Informace k provozu / homologaci

Výrobek je vyráběn dle platných norem EHK-55 R pro prodej ve státech EU. Informace pro použití, provoz a záruky pro tažné zařízení naleznete na našem webu, www.svcgroup.cz

Technické informace > Tažné zařízení > Všeobecné podmínky použití výrobku. Nebo si je stáhněte aplikace přes přiložený QR-cod

Součástí dodávky tažného zařízení je dodán TYPOVÝ LIST. Tento typový list slouží pro zapsání výrobku do technického průkazu vozidla, a obsahuje základní podmínky pro použití výrobku.

Typový list slouží i jako záruční lis proto jej uschovejte v dokumentaci vozidla.

SK Informácie na prevádzku / homologáciu

Výrobok je vyrábaný podľa platných noriem EHK-55 R pre predaj v štátoch EÚ. Informácie pre použitie, prevádzku a záruky pre ťažné zariadenie nájdete na našom webe, www.svcgroup.cz

Technické informácie > Ťažné zariadenie > Všeobecné podmienky použitia výrobku. Alebo si ich stiahnite aplikácie cez priložený QR-cod

Súčasťou dodávky ťažného zariadenia je dodaný TYPOVÝ LIST. Tento typový list slúži pre zapísanie výrobku do technického preukazu vozidla, a obsahuje základné podmienky použitia výrobku.

Typový list slúži aj ako záručný lis preto ho uschovajte v dokumentácii vozidla.

EN Operating / homologation information

The product is manufactured according to the applicable EHK-55 R standards for sale in EU countries. Information on the use, operation and warranties for the towbar can be found on our website, www.svcgroup.com

Technical information > Towing hitch > General conditions of use. Or download them via QR-cod

The towing device is supplied with a TYPE SHEET. This data sheet is used to enter the product in the vehicle registration document and contains the basic conditions for use of the product.

The data sheet also serves as a warranty press, so keep it in the vehicle documentation.

DE Betriebs / Zulassungsinformationen

Das Produkt wird gemäß den geltenden EHK-55 R-Standards für den Verkauf in EU-Ländern hergestellt. Informationen zu Verwendung, Betrieb und Gewährleistung der Anhängerkupplung finden Sie auf unserer Website www.svcgroup.com

Technische Informationen > Anhängerkupplung > Allgemeine Nutzungsbedingungen. Oder laden Sie sie per QR-Code herunter

Die Anhängervorrichtung wird mit einem TYPENBLATT geliefert. Dieses Datenblatt dient zur Eintragung des Produkts in das Kfz-Kennzeichen und enthält die Grundbedingungen für die Verwendung des Produkts. Das Datenblatt dient auch als Garantiepresse. Bewahren Sie es daher in der Fahrzeugdokumentation auf.

HU Üzemeltetési / homologációs információk

Das Produkt wird gemäß den geltenden EHK-55 R-Standards für den Verkauf in EU-Ländern hergestellt. Informationen zu Verwendung, Betrieb und Gewährleistung der Anhängerkupplung finden Sie auf unserer Website www.svcgroup.com

Technische Informationen > Anhängerkupplung > Allgemeine Nutzungsbedingungen. Oder laden Sie sie per QR-Code herunter

Die Anhängervorrichtung wird mit einem TYPENBLATT geliefert. Dieses Datenblatt dient zur Eintragung des Produkts in das Kfz-Kennzeichen und enthält die Grundbedingungen für die Verwendung des Produkts. Das Datenblatt dient auch als Garantiepresse. Bewahren Sie es daher in der Fahrzeugdokumentation auf.

FR Informations d'exploitation / homologation

Le produit est fabriqué conformément aux normes EHK-55 R applicables pour la vente dans les pays de l'UE. Des informations sur l'utilisation, le fonctionnement et les garanties de l'attelage sont disponibles sur notre site Web, www.svcgroup.com.

Informations techniques > Attelage de remorquage > Conditions générales d'utilisation. Ou téléchargez-les via QR-cod

Le dispositif de remorquage est fourni avec une feuille de type. Cette fiche technique est utilisée pour entrer le produit dans le certificat d'immatriculation du véhicule et contient les conditions de base pour l'utilisation du produit. La fiche technique sert également de presse de garantie, conservez-la dans la documentation du véhicule.

IT Informazioni sull'operazione / omologazione

Il prodotto è fabbricato secondo le norme EHK-55 R applicabili in vendita nei paesi dell'UE. Informazioni sull'uso, il funzionamento e le garanzie per il gancio di traino sono disponibili sul nostro sito Web www.svcgroup.com

Informazioni tecniche > Gancio di traino > Condizioni generali d'uso. Oppure scaricali tramite QR-cod

Il dispositivo di rimorchio viene fornito con una SCHEDA TIPO. Questa scheda tecnica viene utilizzata per inserire il prodotto nel certificato di immatricolazione del veicolo e contiene le condizioni di base per l'uso del prodotto. La scheda tecnica funge anche da stampa di garanzia, quindi conservala nella documentazione del veicolo.



SVC GROUP s.r.o. Průmyslová zóna - 179 547 01 Náchod-ČR

www.svcgroup.cz

e-mail: svc@svcgroup.cz

Tel.: +420 491 421 021

+420 491 421 022

mob.: +420 603360607

SVC GROUP ©- 05/19

QR kódem stáhněte rozšířený montážní návod / QR-kóddal letöltheti a kibővített összeszerelési utasításokat



T-2

NL Monteringsanvisningar

Het product is vervaardigd volgens de toepasselijke EHK-55 R-normen voor verkoop in EU-landen. Informatie over het gebruik, de werking en de garanties voor de trekhaak vindt u op onze website, www.svcgroup.com *Technische informatie* > *Trekhaak* > *Algemene gebruiksvoorwaarden*. Of download ze via QR-cod
Het sleepapparaat wordt geleverd met een TYPE BLAD. Dit gegevensblad wordt gebruikt om het product in het voertuigregistratiedocument in te voeren en bevat de basisvoorwaarden voor het gebruik van het product. Het gegevensblad dient ook als garantiepers, dus bewaar het in de voertuigdocumentatie.

ES Instrucciones de montaje

El producto se fabrica de acuerdo con los estándares EHK-55 R aplicables para la venta en países de la UE. Puede encontrar información sobre el uso, el funcionamiento y las garantías de la barra de remolque en nuestro sitio web, www.svcgroup.com *Información técnica* > *Enganche de remolque* > *Condiciones generales de uso*. O descárguelos a través de QR-cod
El dispositivo de remolque se suministra con una HOJA DE TIPO. Esta hoja de datos se utiliza para ingresar el producto en el documento de registro del vehículo y contiene las condiciones básicas para el uso del producto. La hoja de datos también sirve como una prensa de garantía, por lo tanto, consérvela en la documentación del vehículo.

FIN Montage-instructie

Tuote on valmistettu EU-maissa myytävien EHK-55 R-standardien mukaisesti. Tietoja vetokoukun käytöstä, käytöstä ja takuista löytyy verkkosivuiltamme www.svcgroup.com *Tekniset tiedot* > *Vetokoukku* > *Yleiset käyttöolosuhteet*. Tai lataa ne QR-koodin kautta
Hinauslaite toimitetaan TYYPPI-ARKKI. Tätä lomaketta käytetään tuotteen syöttämiseen ajoneuvon rekisteröintitodistukseen, ja se sisältää tuotteen käytön perusedellytykset. Tietolomake toimii myös takuupuristimena, joten säilytä se ajoneuvon dokumenteissa.

SL

Izdelek je izdelan po veljavnih standardih EHK-55 R za prodajo v državah EU. Informacije o uporabi, delovanju in garancijah za vlečno ploščo najdete na našem spletnem mestu www.svcgroup.com *Tehnični podatki* > *Vlečna kljuka* > *Splošni pogoji uporabe*. Ali pa jih prenesite preko QR-kod
Vlečna naprava je opremljena s TIPNIM LISTOM. Ta podatkovni list se uporablja za vnos izdelka v registracijski dokument vozila in vsebuje osnovne pogoje za uporabo izdelka. Podatkovni list služi tudi kot garancijski tisk, zato ga hranite v dokumentaciji vozila.

NOR Drifts- / homologasjonsinformasjon

Produktet er produsert i henhold til gjeldende EHK-55 R standarder for salg i EU-land. Informasjon om bruk, drift og garantier for tilhengerfeste finner du på vår hjemmeside, www.svcgroup.com
Teknisk informasjon > *Tilhengerfeste* > *Generelle bruksbetingelser*. Eller last dem ned via QR-koding
Tøeanordningen leveres med TYPEBLAD. Dette databladet brukes til å oppgi produktet i kjøretøyets registreringsbevis og inneholder de grunnleggende betingelsene for bruk av produktet. Databladet fungerer også som garantipresse, så hold det i bilens dokumentasjon.

PL Informacje dotyczące pracy / homologacji

Produkt jest wytwarzany zgodnie z obowiązującymi normami EHK-55 R na sprzedaż w krajach UE. Informacje na temat użytkowania, obsługi i gwarancji na hak holowniczy można znaleźć na naszej stronie internetowej www.svcgroup.com *Informacje techniczne* > *Zacpek holowniczy* > *Ogólne warunki użytkowania*. Lub pobierz je za pomocą kodu QR
Urządzenie holownicze jest dostarczane z ARKUSZEM TYPU. Ta karta danych służy do wpisania produktu do dokumentu rejestracyjnego pojazdu i zawiera podstawowe warunki użytkowania produktu. Karta danych służy również jako prasa gwarancyjna, dlatego przechowuj ją w dokumentacji pojazdu.

RU Информация о работе / омологации

El producto se fabrica de acuerdo con los estándares EHK-55 R aplicables para la venta en países de la UE. Puede encontrar información sobre el uso, el funcionamiento y las garantías de la barra de remolque en nuestro sitio web, www.svcgroup.com
Información técnica > *Enganche de remolque* > *Condiciones generales de uso*. O descárguelos a través de QR-cod
El dispositivo de remolque se suministra con una HOJA DE TIPO. Esta hoja de datos se utiliza para ingresar el producto en el documento de registro del vehículo y contiene las condiciones básicas para el uso del producto. La hoja de datos también sirve como una prensa de garantía, por lo tanto, consérvela en la documentación del vehículo.



SVC GROUP s.r.o. Průmyslová zóna - 179 547 01 Náchod-ČR

www.svcgroup.cz
e-mail: svc@svcgroup.cz

Tel.: +420 491 421 021
+420 491 421 022
mob.: +420 603 360 607

QR kódem stáhnete rozšířený montážní návod / Con il codice QR è possibile scaricare le istruzioni di assemblaggio estese

SVC GROUP ©- 05/19



CZ Pozor informace k záruce
SK Pozor informácie k záruke
EN Note the warranty information
DE Beachten Sie die Garantieinformationen

HU Vegye gyelembe a jótállási információkat
FR Notez les informations de garantie
IT Nota le informazioni sulla garanzia
NL Let op de garantie-informatie

ES Atención
FIN Huomio
PL Uwaga
RU Внимание

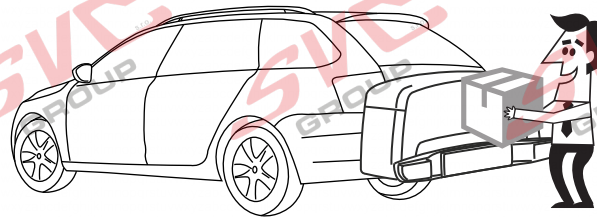
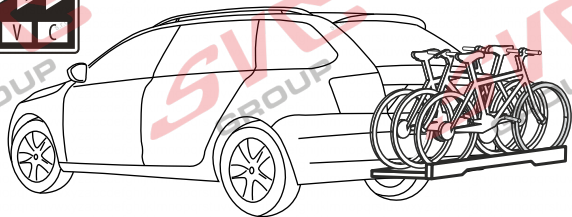

VTZ 001-532
VTZ 003-532

VTZ 002-532



3 **max.**

max. manual

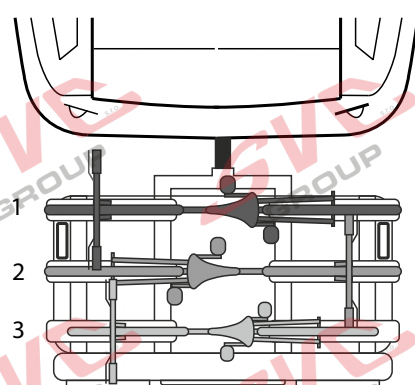

max. manual



max. manual

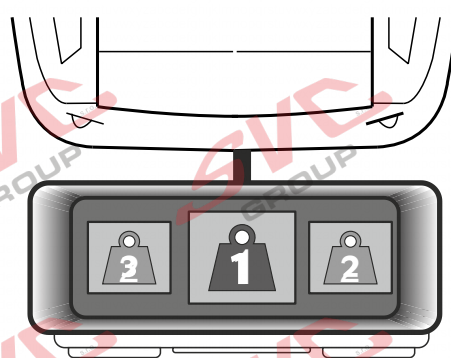

MAX. 5 km/h

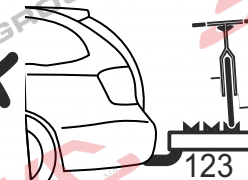
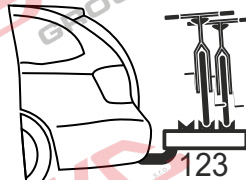
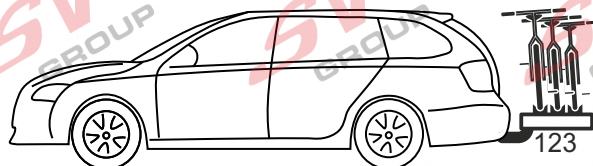
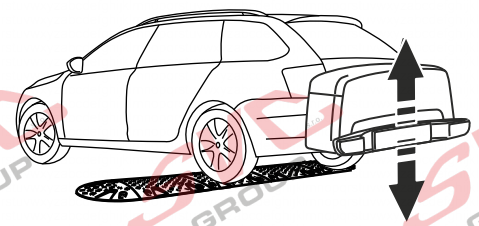
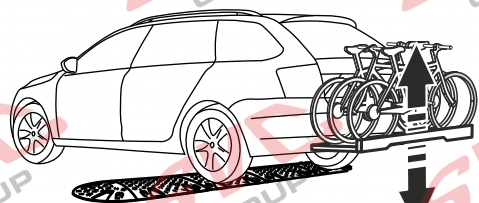

Vysokov 179
 547 01 Náchod, Česká Republika

+420 603 360 607 +420 491421021



www.svcgroup.cz



CZ Pozor informace k záruce
SK Pozor informácie k záruke
EN Note the warranty information
DE Beachten Sie die Garantieinformationen

HU Vegye gyelembe a jótállási információkat
FR Notez les informations de garantie
IT Nota le informazioni sulla garanzia
NL Let op de garantie-informatie

ES Atención
FIN Huomio
PL Uwaga
RU Внимание

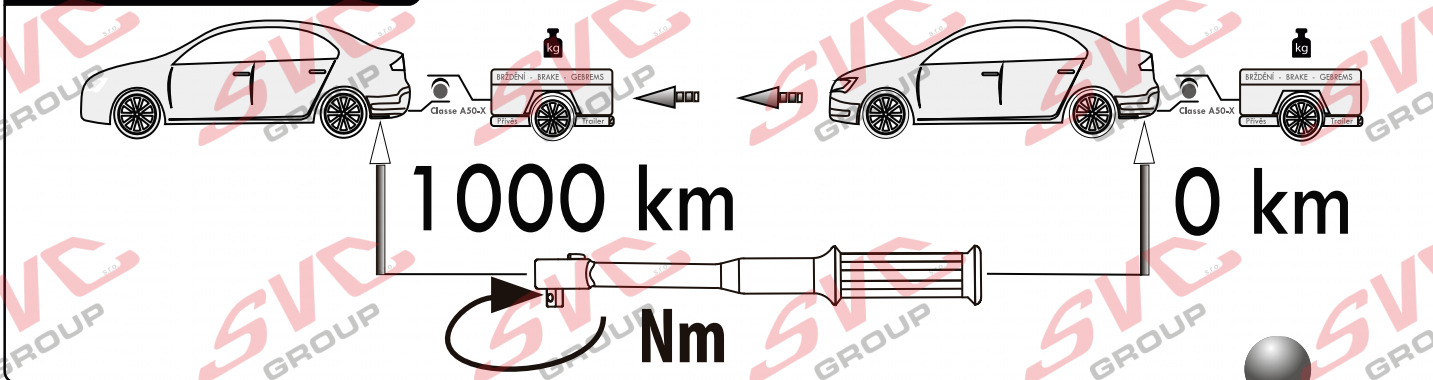
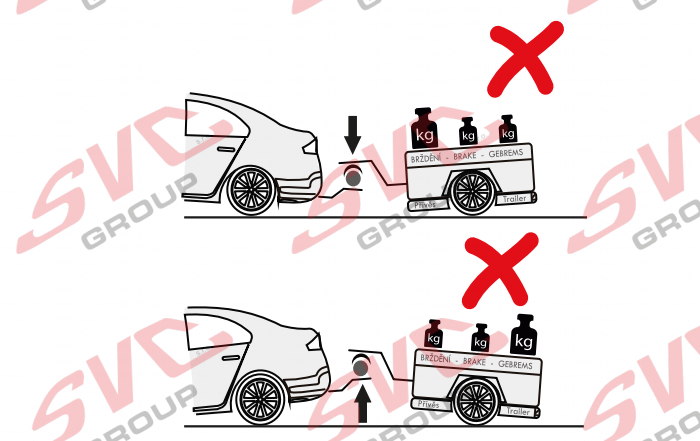
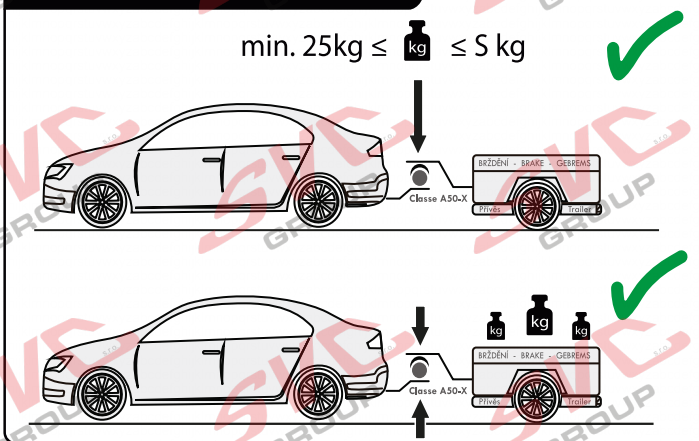
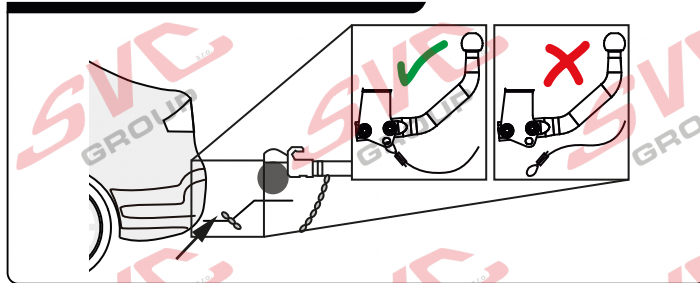
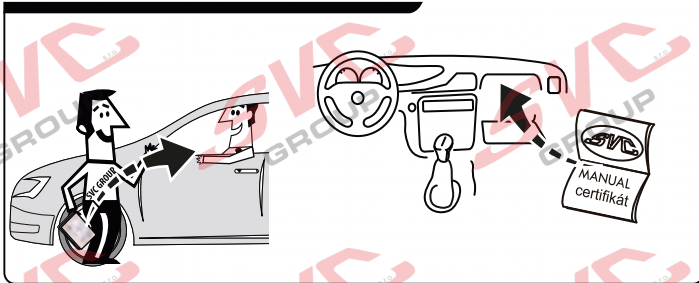
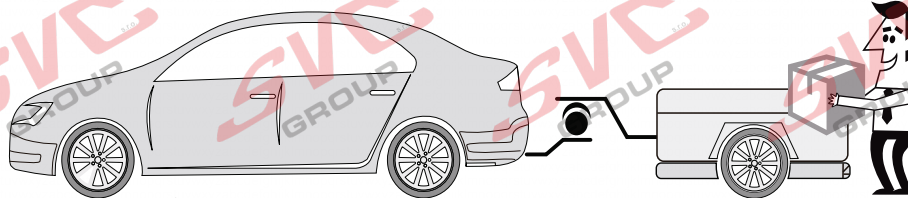

Vysokov 179
 547 01 Náchod, Česká Republika

+420 603 360 607 +420 491421021



www.svcgroup.cz

SVC GROUP ©-08-2019

Service Vitver Centrum