



CZ - Tažné zařízení / SK - Ťažné zariadenie / GB - Towbars / PL - Haki holownicze
DE - Anhängavorrichtungen / FR - Attelages / SPA - Ganchos / emorcaire

TYP VTZ 001-507 VTZ 002-507 VTZ 003-507



www.svcgroup.cz



SVC GROUP s.r.o
Průmyslová zóna 179
547 01 Náchod
Česká republika

Hyundai Combi

Crosswagon - CW



r.v. 2020 ->



1->2,0 h



2->2,5 h

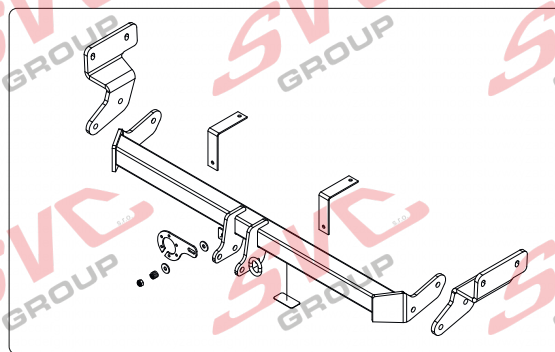
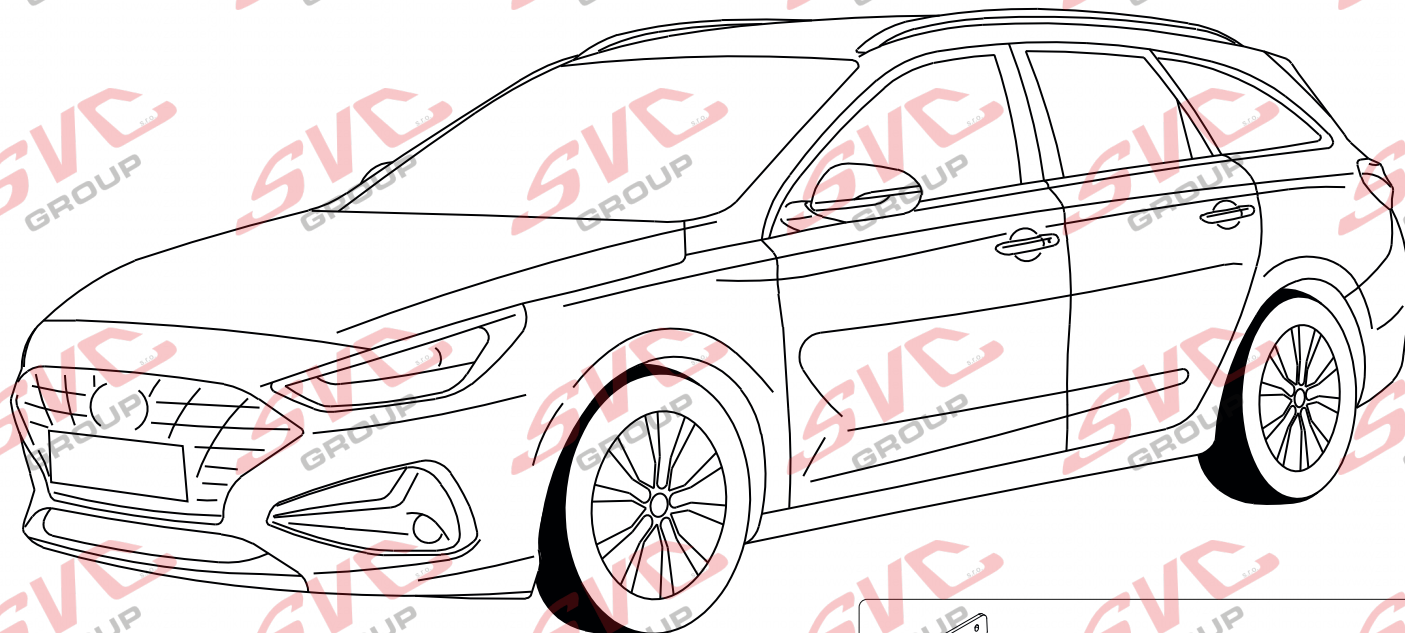

CZ Pro podrobné montážní instrukce a podmínky výrobku si naskenujte QR kód
SK Pre podrobné montážne pokyny a podmienky produktu si môžete skenovať QR kód
GB For detailed installation instructions and product conditions, scan the QR code
DE Scannen Sie den QR-Code, um detaillierte Installationsanweisungen und Produktbedingungen zu erhalten
FR Pour des instructions d'installation détaillées et les conditions du produit, scannez le code QR
ITA Per istruzioni di installazione dettagliate e condizioni del prodotto, eseguire la scansione del codice QR
PL Aby uzyskać szczegółowe instrukcje dotyczące instalacji i warunki produktu, zeskanuj kod QR
SP Para obtener instrucciones detalladas de instalación y condiciones del producto, escanee el código QR
NL Voor gedetailleerde installatie-instructies en productvoorwaarden, scan de QR-code
FIN Tarkemmat asennusohjeet ja tuotteen ehdot on tarkistettava QR-koodilla
HU A részletes telepítési utasítások és a termék feltételei között olvassa el a QR kódot
SLO Za podrobna navodila za namestitve in pogoje izdelka skenirajte kodo QR
RU Подробные инструкции по установке и условиям продукта отсканируйте QR-код.

e-mail: scv@scvgroup.cz Tel.: +420 491421021 +420 491421022 mob.: +420 603360607



Hyundai I30 Combi r.v. 2020 ->



VTZ 001-507

16,3



A-507-2020



VTZ 002-507

16,9



V-507-2020



VTZ 003-507

18,9



AV-507-2020



23/6000



1 700/100 D=8,91



55R-01-0522



1,5->2,0 h



2->2,5 h

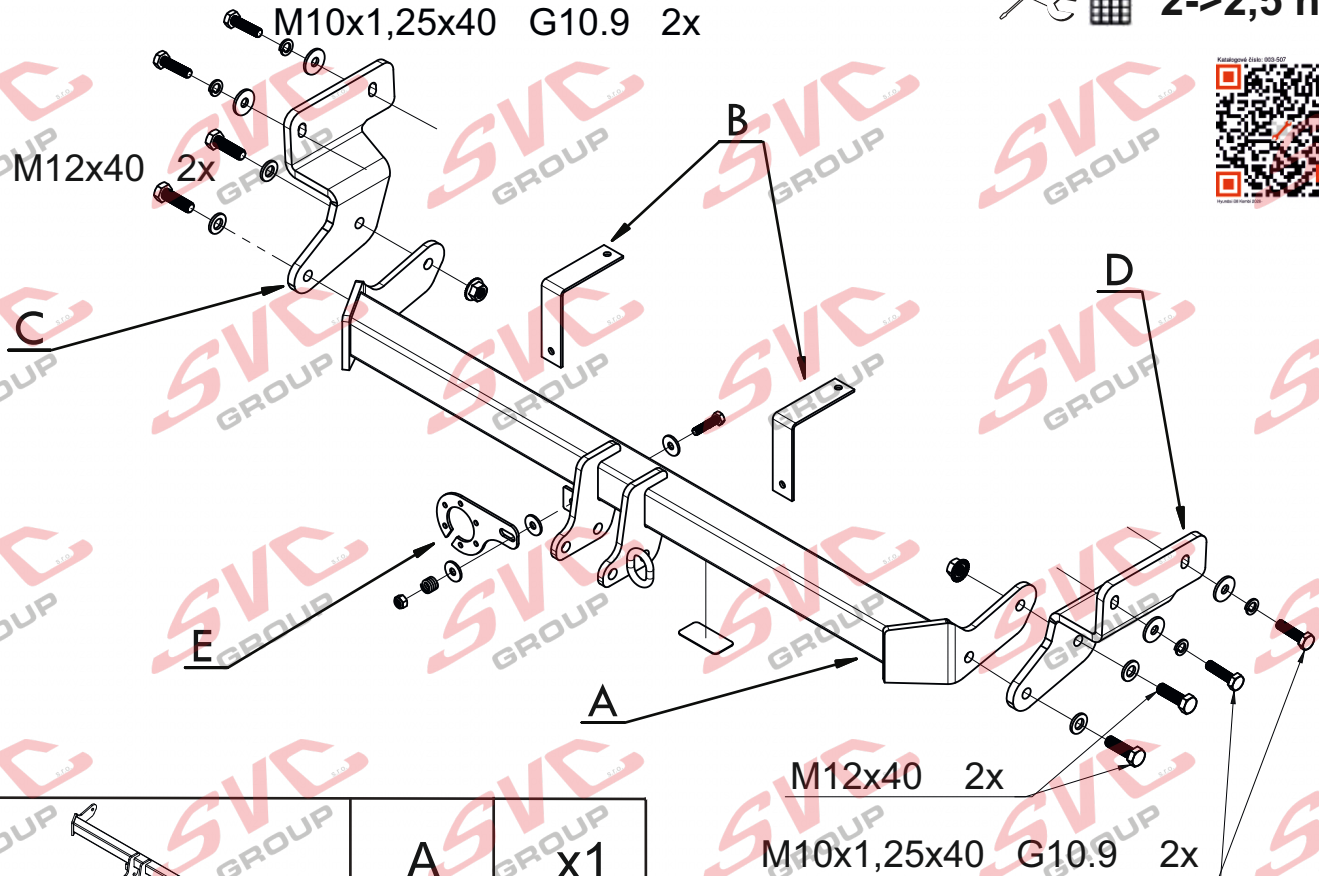

| | | | | | |
|-----------------|--------|------------|--|-------------------|-----|
| | A | x1 | | M10x1,25x40 G10.9 | 4ks |
| | B | x2 | | M12x40 | 4ks |
| | C | x1 | | Ø10 | 4ks |
| | D | x1 | | Ø12 | 4ks |
| | E | x1 | | Ø10 | 4ks |
| | Krátké | x1 | | M12 | 4ks |
| VTZ 001/2/3-507 | | VT-041 1ks | | | |

SVC GROUP



SVC GROUP s.r.o.

Průmyslová zóna - 179

547 01 Náchod-ČR

www.svcgroup.cz

e-mail: svc@svcgroup.cz

Tel.: +420 491421021

+420 491421022

mob.: +420 603360607

ode you an download the extended assembly instructions

SVC GROUP



Hyundai Combi

Crosswagon - CW



.v. 2020 ->

100

1 700

D= 8,91

kN



VTZ 001-507



VTZ 002-507



VTZ 003-507

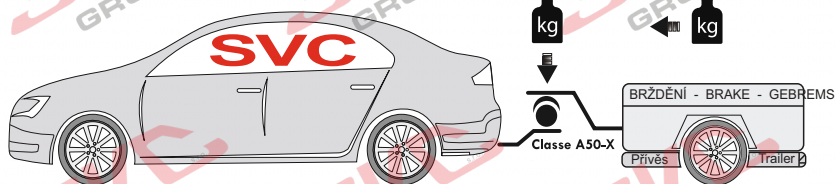

M10x1,25x40 G10.9 2x

M12x40 2x

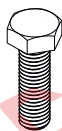

M10x1,25x40 G10.9 4x
M12x40 4x



Ø10 4x



Ø12 4x



Ø10 4x



M12 4x

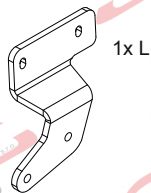

1x L

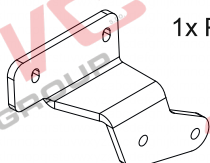

1x P

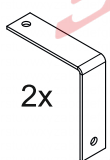

2x

M12x40 2x

M10x1,25x40 G10.9 2x

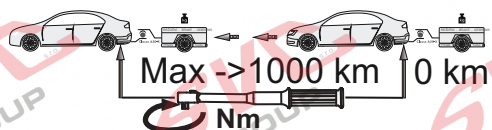
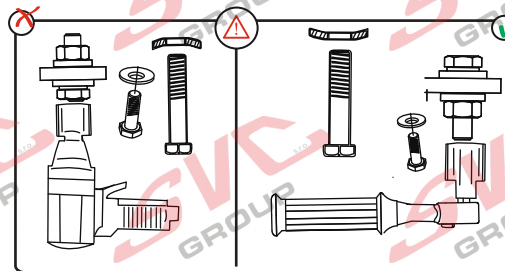

| Pevnost | 8,8 | 10,9 | 12,9 |
|---------|-------|-------|-------|
| M6 | 9,7 | 14,3 | 16,1 |
| M8 | 24,5 | 35,9 | 42,0 |
| M10 | 48,4 | 71,0 | 83,0 |
| M12 | 84,0 | 123,0 | 144,0 |
| M14 | 133,0 | 196,0 | 229,0 |
| M16 | 137,0 | 307,0 | 359,0 |



Nm



Homologce EHK 55-R

55R-01-0494

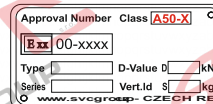

- | | |
|---|--|
| CZ Informace k provozu / homologaci | NL Monteringsanvisningar |
| SK Informácie na prevádzku / homologáciu | ES Instrucciones de montaje |
| EN Operating / homologation information | FIN Montage-instructie |
| DE Betriebs- / Zulassungsinformationen | SV Asennusohjeet |
| HU Üzemeltetési / homologációs információk | NOR Drifts- / homologasjonsinformasjon |
| FR Informations d'exploitation / homologatio | PL Informacje dotyczące pracy / homologacji |
| IT Informazioni sull'operazione / omologazio | RU Информация о работе / омологации |



SVC GROUP s.r.o.

Průmyslová zóna - 179
547 01 Náchod-ČR

www.svcgroup.cz
e-mail: svc@svcgroup.cz

Tel.: +420 491421021
+420 491421022
mob.: +420 603360607

önnen Sie die erweiterte Montageanleitung herunterladen

SVC GROUP ©-



Hyundai Combi

Crosswagon - CW



.v. 2020 ->

N-1

CS Montážní návod

Pro podrobné montážní instrukce a podmínky výrobku si naskenujte QR kód

1. Odmontujte zadní světlá, nárazník s jeho výztuhou (pozor na elektroinstalaci). Odmontujte levou a pravou plastovou kapsu u nosníků.
2. Namontujte levý a pravý bok tažného zařízení k nosníkům za pomoci šroubů M10x1.25x40 (10.9) přes velkoplošné podložky. Mezi takto připravené boky namontujte hlavní nosník tažného zařízení za pomoci 4 šroubů M12x40. Tažné zařízení vyrovnejte a dotáhněte dle utahovacích momentů.
3. Upravte plastovou výztuhu dle obrázků, vyměňte plastové držáky za kovové. Zhotovte výřez nárazníku dle typu tažného zařízení.
4. Namontujte zpět všechny díly odmontované v bodě č. 1.

EN Installation instructions

For detailed installation instructions and product conditions, scan the QR code

1. Remove rear lights and the bumper with its plastic stiener (be careful not to damage the wiring). Remove left and right plastic pockets near the beams.
2. Install left and right sides of the tow bar to the beams using screws M10x1.25x40 (10.9) and large-area washers. With using of 4 screws M12x40 install the main beam of the tow bar between the sides prepared in previous step. Align all the parts of the tow bar and tighten them to prescribed torques.
3. Modify the plastic stiener according to the picture and replace plastic holders with the metal ones. Make a cut-out in the bumper according to the type of tow bar.
4. Reinstall all the parts removed within the step 1.

SK Montážny návod

Pre podrobné montážne pokyny a podmienky produktu si môžete skenovať QR kód

1. Demontirajte zadnje luči, odbijač in njegovo ojačitev (bodite pozorni na ožičenje). Odstranite levi in desni plastični žep zraven nosilcev.
2. Pritrdite levo in desno bočno stran vlečne kljuke na nosilca s pomočjo vijakov M10x1.25x40 (10.9) in širokih podložk. Med tako pripravljene bočni strani namestite glavni nosilec vlečne kljuke s 4 vijaki M12x40. Poravnajte vlečno kljuko in jo zategnite glede na zatezne momente.
3. Prilagodite plastično ojačitev glede na slike, plastična držala pa zamenjajte s kovinskimi. Naredite izrez za odbijač glede na tip vlečne kljuke.
4. Vse dele, demontirane v točki št. 1, montirajte nazaj.

DE Montageanleitung

Scannen Sie den QR-Code, um detaillierte Installationsanweisungen und Produktbedingungen zu erhalten

1. Hecklichter, Stoßstange und deren Strebe ausbauen (Achtung auf Elektroinstallation). Linke und rechte Kunststofftasche bei den Trägern demontieren.
2. Rechte und linke Seite der Zugeinrichtung an die Träger mit den Schrauben M10x 1.25x40 (10.9) und großächigen U-Scheiben montieren. Zwischen die derart vorbereiteten Seitenteile den Hauptträger der Zugeinrichtung mit 4 Schrauben M12x40 montieren. Die Zugeinrichtung ausrichten und entsprechend den Anzugsmomenten festziehen.
3. Die Kunststoffstrebe anpassen, s. Abbildungen, und Kunststhalter durch Metallhalter ersetzen. In der Stoßstange einen Ausschnitt je nach dem Typ der Zugeinrichtung herstellen.
4. Alle im Punkt Nr. 1 ausgebauten Teile wieder einbauen.

PL Instrukcja montażu

Aby uzyskać szczegółowe instrukcje instalacji i warunki produktu, zeskanuj kod QR

1. Demontujemy tylne lampy i zderzak z jego wzmocnieniem (uwaga na instalację elektryczną). Demontujemy lewą i prawą plastikową kieszeń koło belek.
2. Montujemy lewy i prawy bok haka holowniczego do belek za pomocą śrub M10x1.25x40 (10.9) przez podkładki wielkopowierzchniowe. Między tak przygotowanymi bokami montujemy główną belkę haka holowniczego za pomocą 4 śrub M12x40. Ustawiamy równo hak holowniczy i dokręcamy go z zachowaniem zalecanych momentów.
3. Plastikowe wzmocnienie przystosowujemy zgodnie z rysunkami, plastikowe uchwyty wymieniamy na metalowe. Wykonujemy wycięcie w zderzaku zgodnie z typem haka holowniczego.
4. Montujemy z powrotem wszystkie części zdemontowane w punkcie nr 1.

FR Notice de montage

Pour des instructions d'installation détaillées et les conditions du produit, scannez le code QR

1. Déposer les feux arrières, le pare-chocs et son renfort (faire attention à l'installation électrique). Retirez la poche gauche et droite en plastique des travers.
2. À l'aide des vis M10x1.25x40 (10.9) et des larges rondelles, monter le côté gauche et droit du dispositif d'attelage sur les travers. À l'aide des 4 vis M12x40, monter la traverse principale du dispositif d'attelage entre les côtés ainsi préparés. Aligner le dispositif d'attelage et serrer aux couples préconisés.
3. Ajuster le renfort en plastique selon les images, remplacer les supports en plastique par des supports métalliques. Faire une découpe du pare-chocs en fonction du type de dispositif d'attelage.
4. Reposer toutes les pièces déposées à la section n°1.

FI Asennusohje

Tarkemmat asennusohjeet ja tuotteen ehdot on tarkistettava QR-koodilla

1. Irrota takavalot, puskuri ja sen jäykiste (varo sähkölaitteita). Irrota palkkien vasen ja oikea muovitasku.
2. Asenna vetolaitteen vasen ja oikea sivuosa palkkeihin ruuveilla M10x1.25x40 (10.9) suurilla aluslevyjä käyttäen. Asenna näin valmistettujen sivuosien väliin vetolaitteen pääpalkki 4 ruuvilla M12x40. Suorista vetolaite ja kiristä kiristysmomenttien mukaisesti.
3. Korjaa muovijäykistettä kuvien mukaisesti, vaihda muovipidikkeet metallisiin. Tee puskuriin leikkaus vetolaitteen tyyppiin mukaan.
4. Asenna takaisin kaikki kohdassa 1. irrotetut osat.



SVC GROUP s.r.o.

Průmyslová zóna - 179

www.svcgroup.cz

Tel.: +420 491421021

+420 491421022

547 01 Náchod-ČR

e-mail: svc@svcgroup.cz

mob.: +420 603360607

ode you an download the extended assembly instructions

SVC GROUP © 05/19

QR k

1.

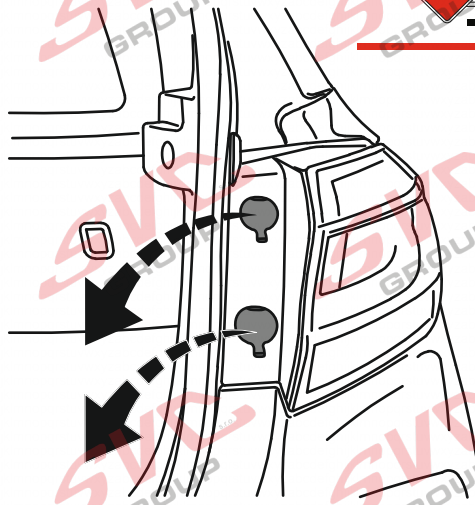
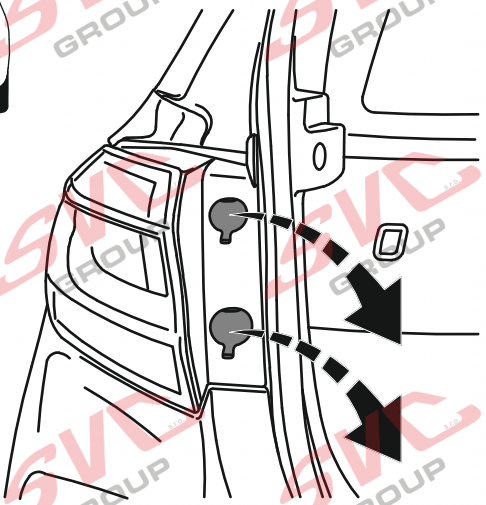
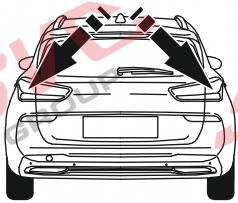

2.

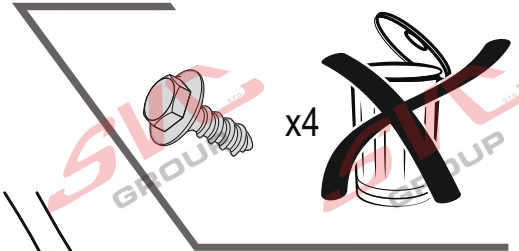
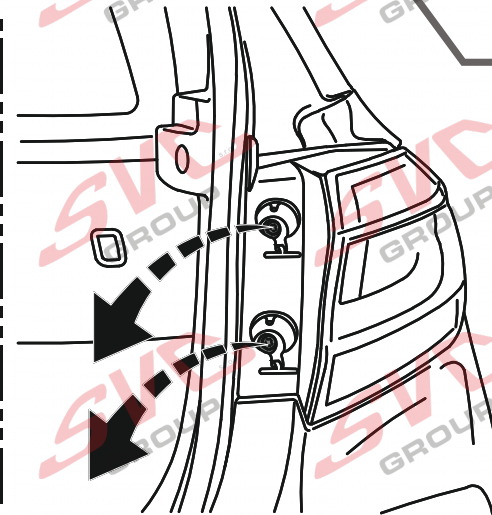
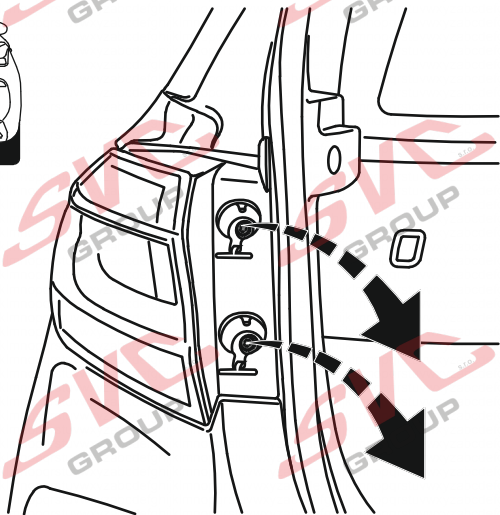
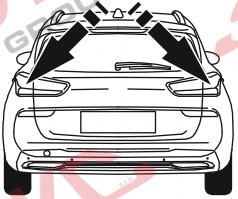

x4

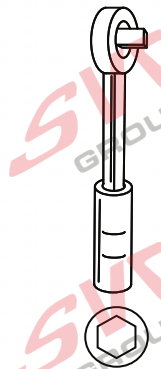

3.

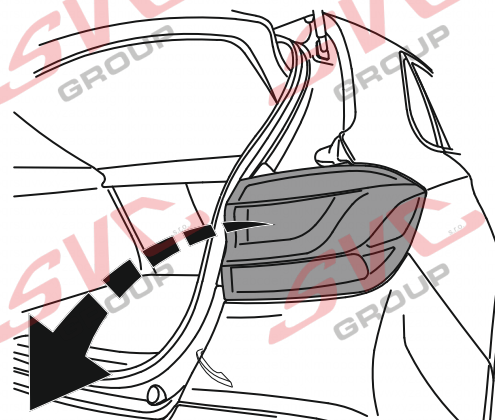
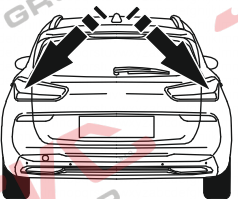

4.

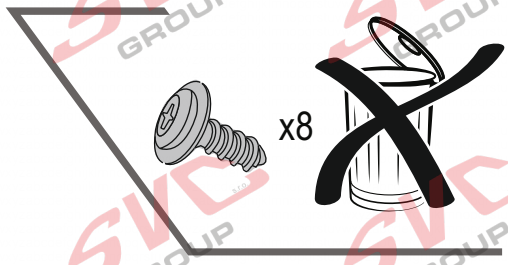
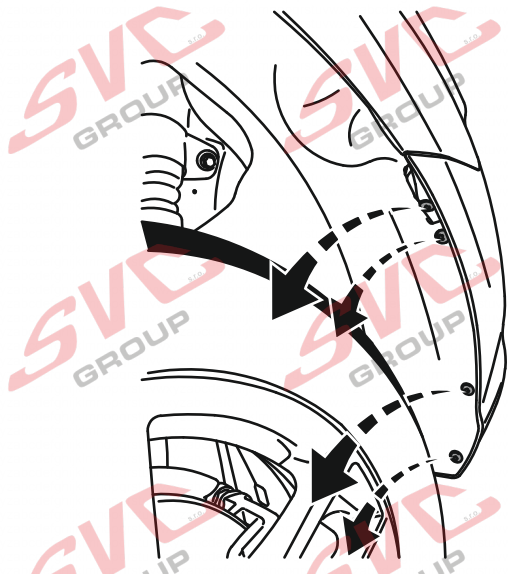
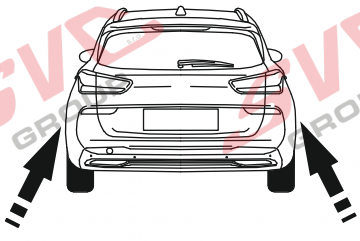

5.

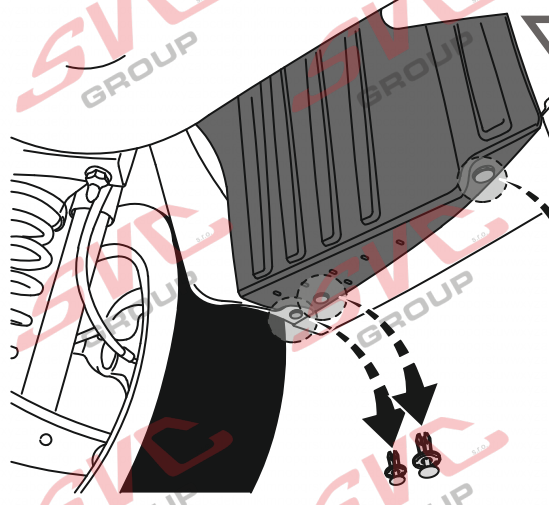
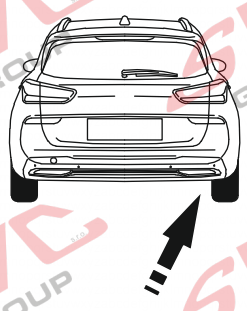

6.

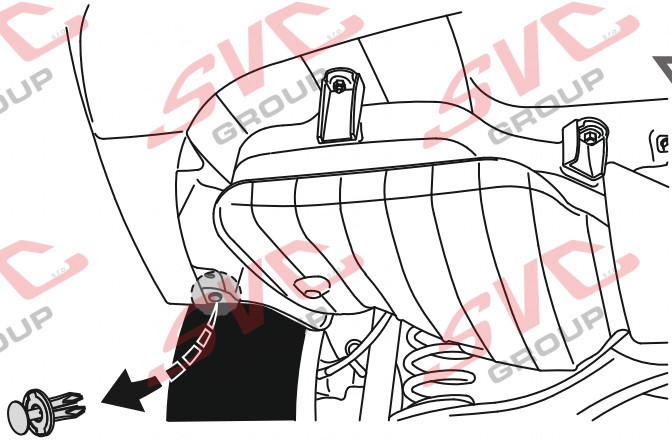
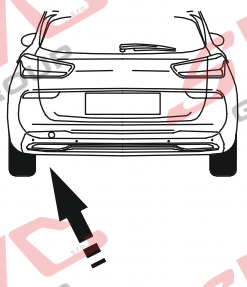

7.

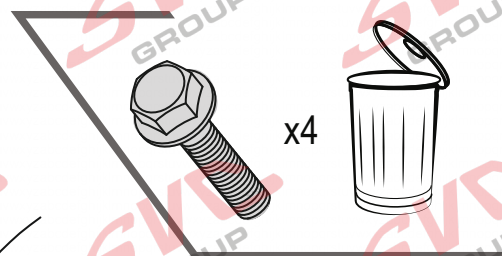
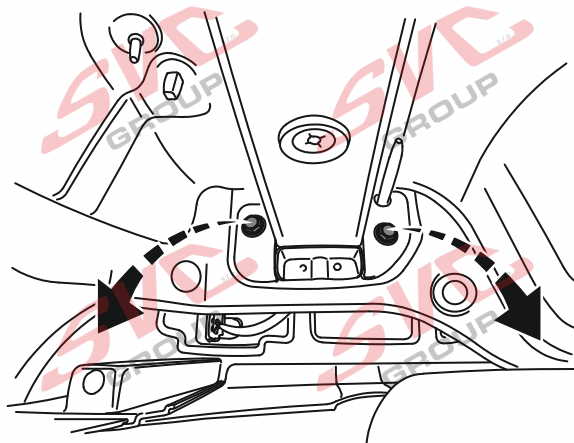
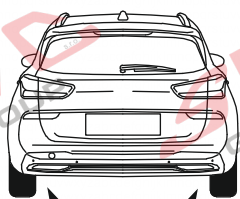

8.

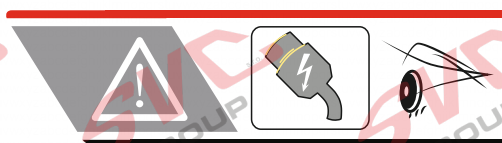
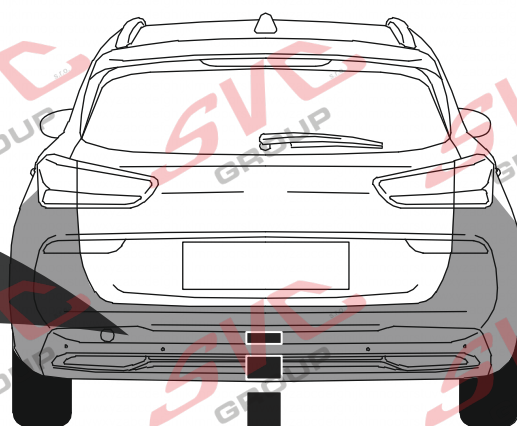
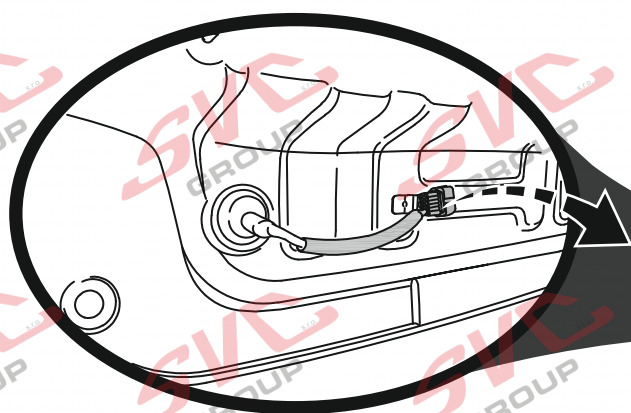

9.

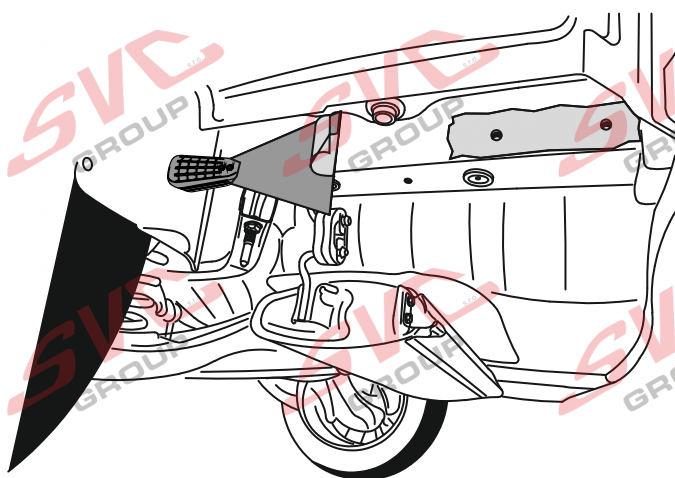
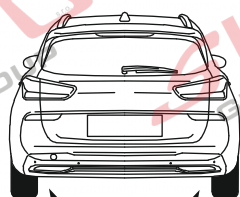

10.

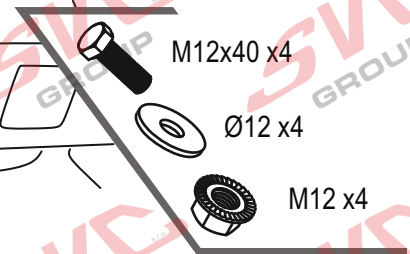
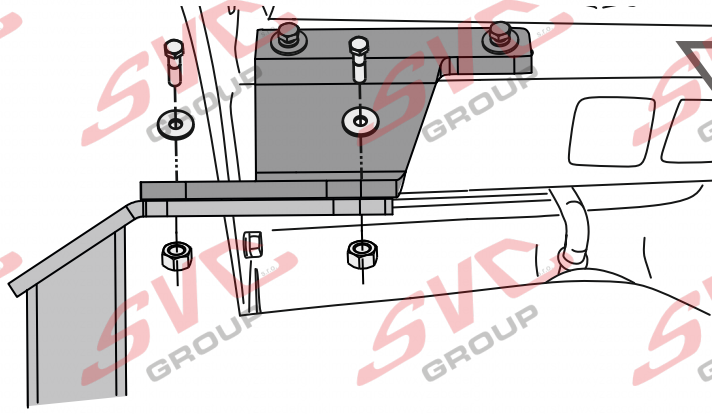
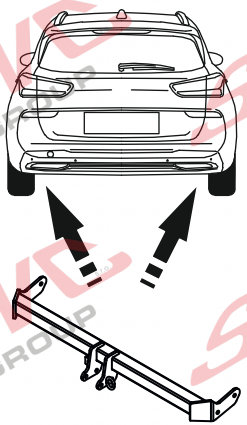
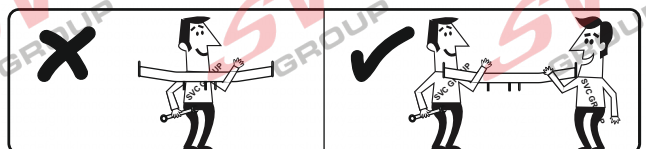
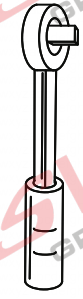
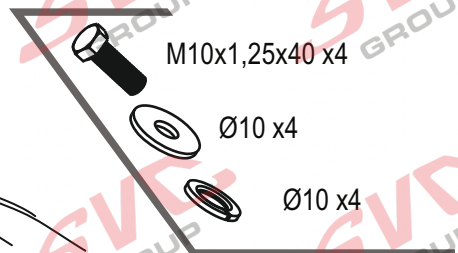
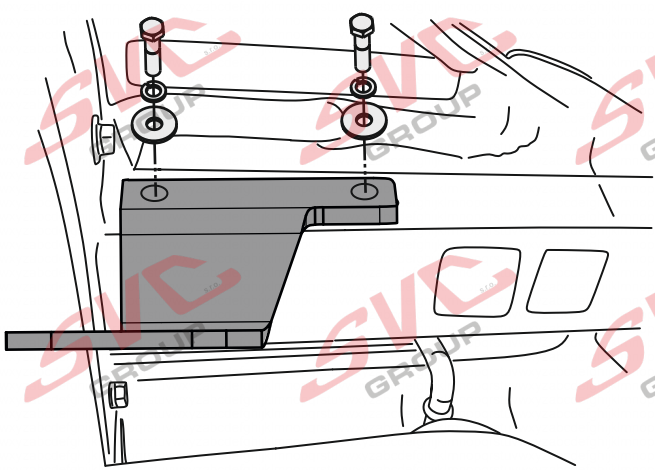
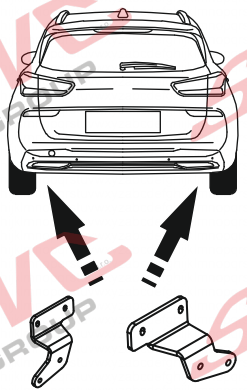

11.

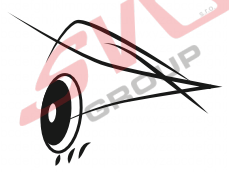
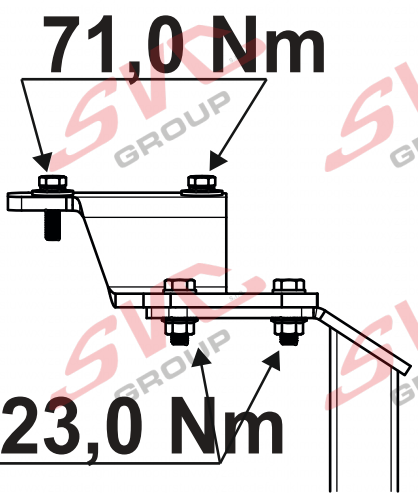
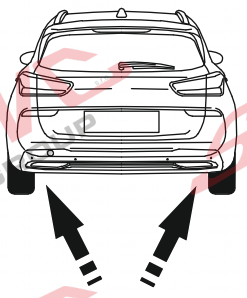

10

12

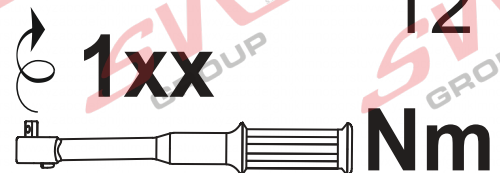



12.

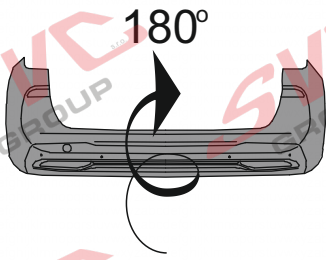

POHLED
OD SPODU
NÁRAZNÍKU

OSA VOZIDLA

SPODNÍ VIDITELNÁ HRANA NÁRAZNÍKU

Š-B

2-B

VÝŘEZ SVC

180 mm
180 mm

20 mm
5 mm

70 mm
40 mm

85 mm
65 mm



KONEC ČERNÉHO PLASTU



13.

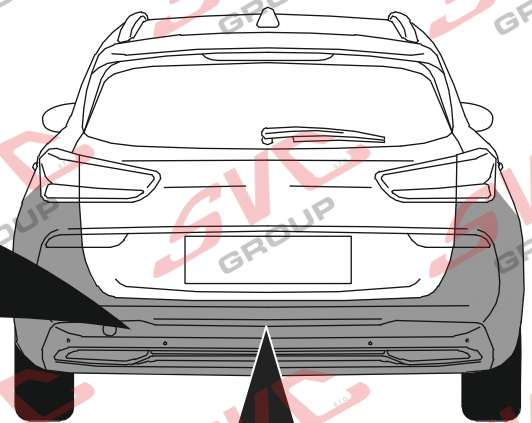
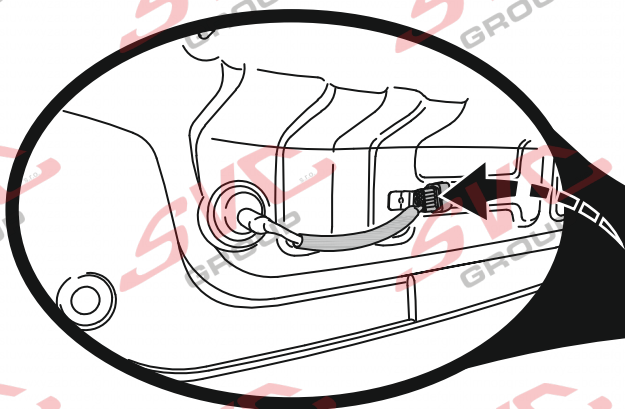

14.

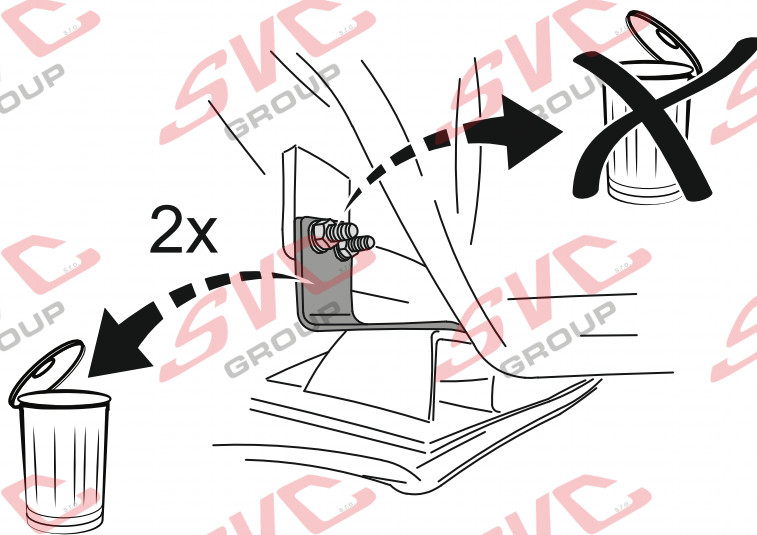
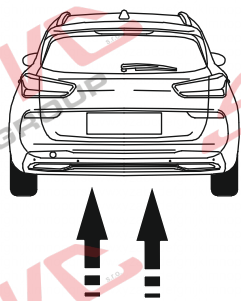

15.

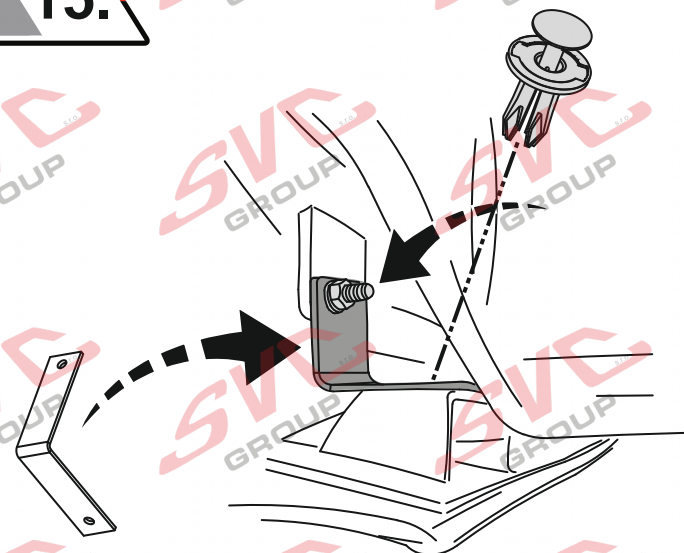
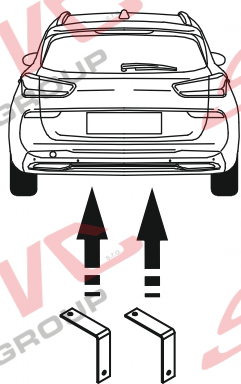

16.

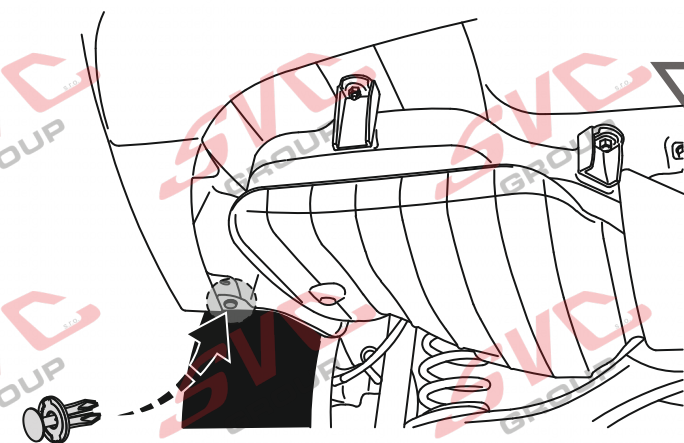
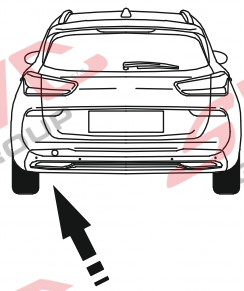

17.

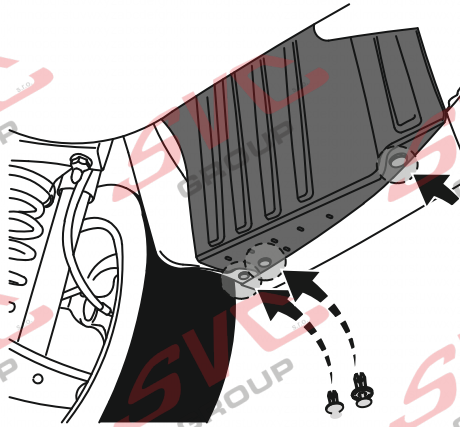
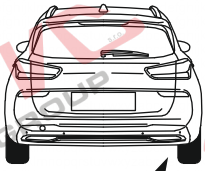

x3



18.

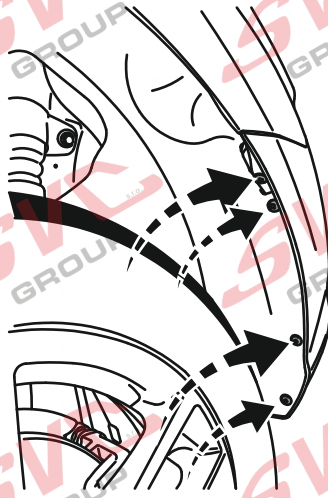
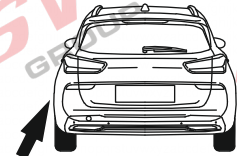

x8



19.

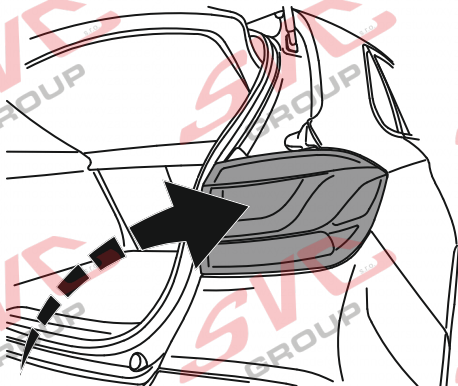
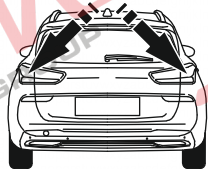

x4

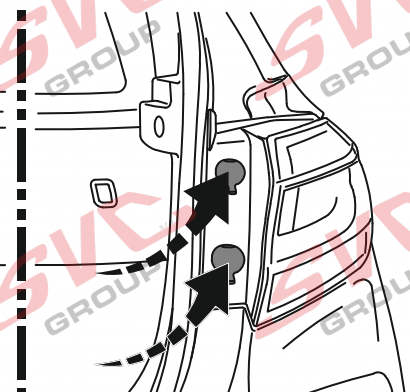
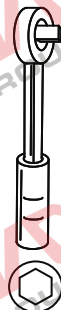

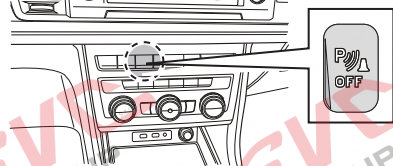
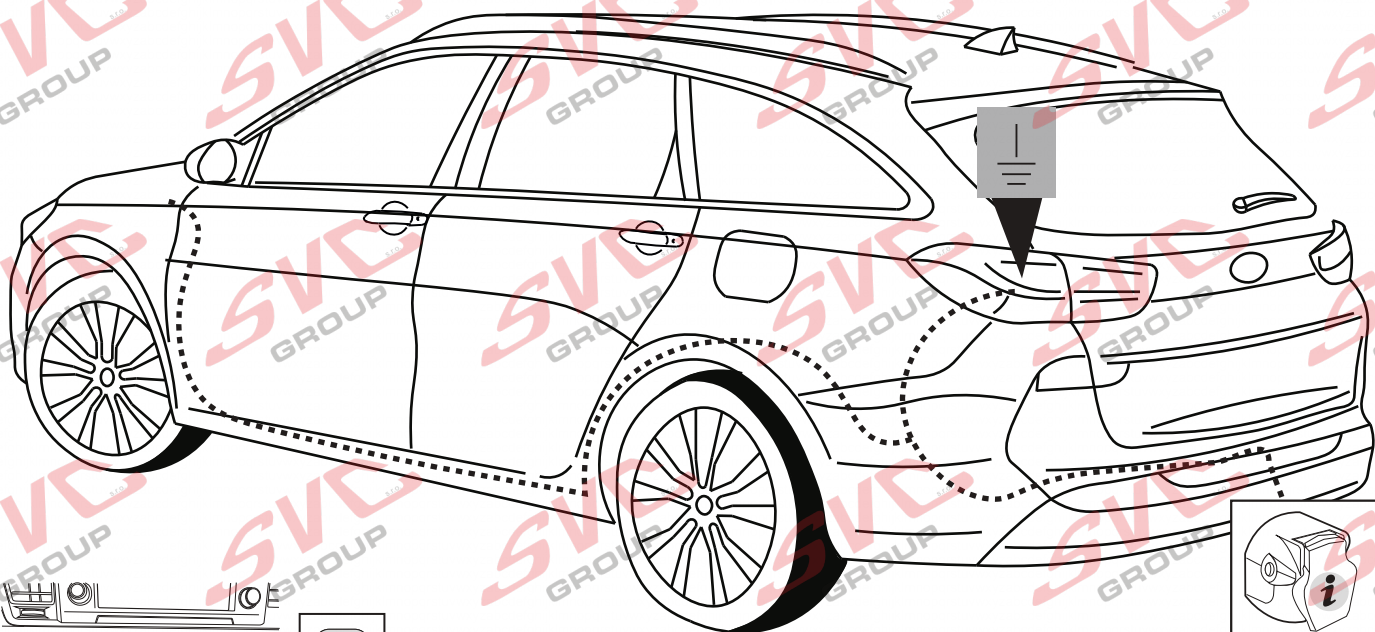
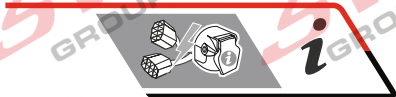

Informace pro odpojování couvacích senzorů PDC pro tažné zařízení

Vypínač pro vypínání couvacích senzorů PDC je umístěný na palubní desce vozu.

Nemusíte tedy pracně na elektro instalaci vozu napojovat odpojování couvacích senzorů PDC a zpětných kamer od elektro přípojky tažných zařízení.

Pokud chcete senzory vypnout, použijte vypínač na palubní desce.

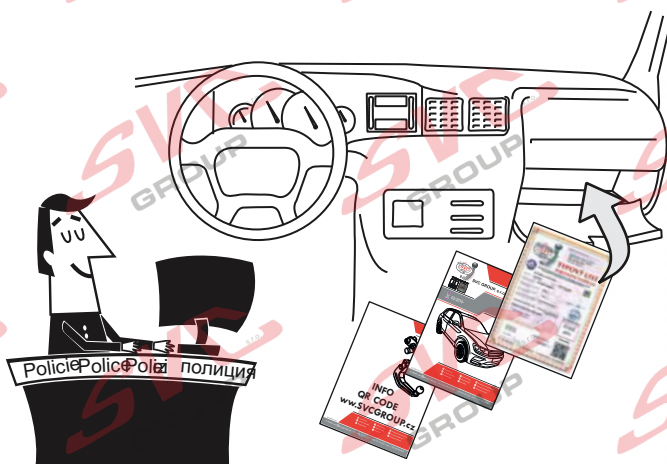
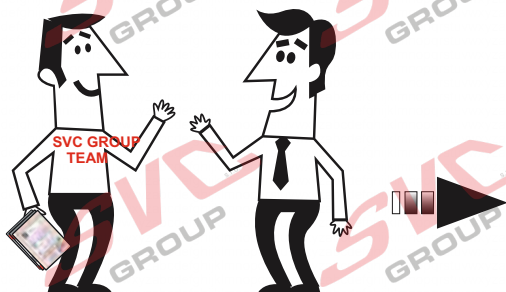

SVC GROUP

Děkuje za důvěru / Дякує за довіру
Thank you for trust / Danke für Vertrauen
Merci pour votre confiance / Grazie per la tua fiducia
Tankwól foar jû fertrouwen / Спасібо за за́віренн

Registrace / Registrácia
Registration / Registrierung
Inscription / Registrare
Rekstrinti / Регістрація

