

Tažné zařízení MG ZS a ZS.EV

Originál SVC GROUP s.r.o.

01/2019->



Tažné zařízení
Anhängvorrichtungen
Attelages
TOWBARS

SVC GROUP s.r.o.

Vysokov 179, 547 01 Náchod, Česká Republika



www.svcgroup.cz



Katalogové číslo / Catalogue number / Katalognummer / Numero di catalogo:

VTZ 001-531

VTZ 002-531

VTZ 003-531

LUXURY
CONFORT

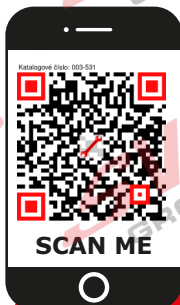
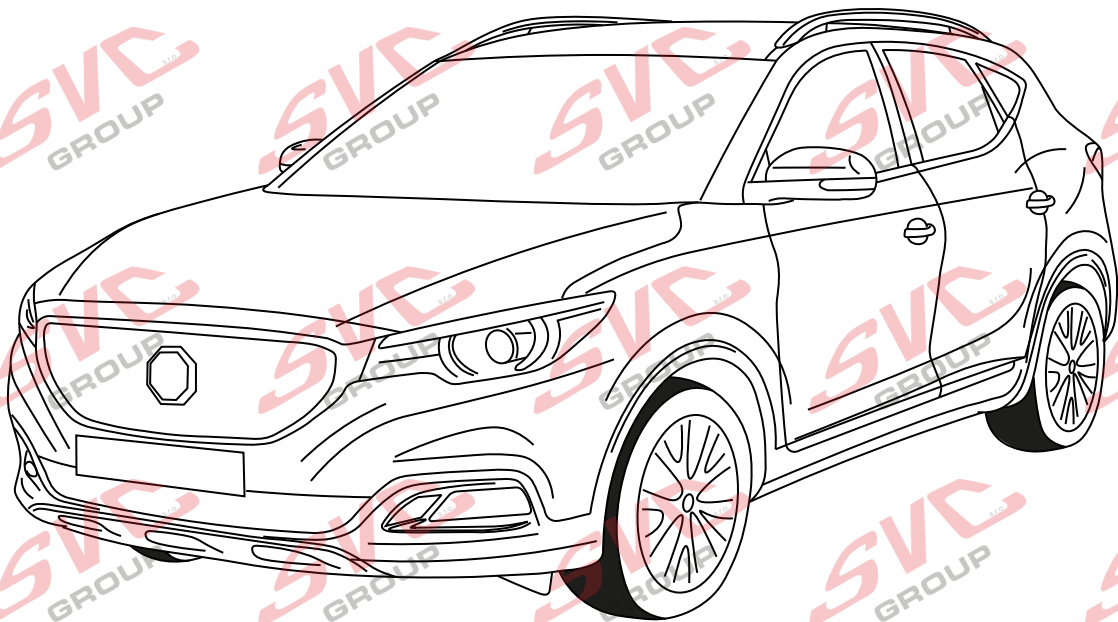
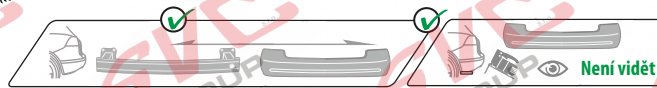

- CZ Pro podrobné montážní instrukce a podmínky výrobku si naskenujte QR kód
- SK Pre podrobné montážne pokyny a podmienky produktu si môžete skenovať QR kód
- GB For detailed installation instructions and product conditions, scan the QR code
- DE Scannen Sie den QR-Code, um detaillierte Installationsanweisungen und Produktbedingungen zu erhalten
- FR Pour des instructions d'installation détaillées et les conditions du produit, scannez le code QR
- ITA Per istruzioni di installazione dettagliate e condizioni del prodotto, eseguire la scansione del codice QR
- PL Aby uzyskać szczegółowe instrukcje dotyczące instalacji i warunki produktu, zeskanuj kod QR
- SP Para obtener instrucciones detalladas de instalación y condiciones del producto, escanee el código QR
- NL Voor gedetailleerde installatie-instructies en productvoorwaarden, scan de QR-code
- FIN Tarkemmat asennusohjeet ja tuotteen ehdot on tarkistettava QR-koodilla
- HU A részletes telepítési utasítások és a termék feltételei között olvassa el a QR kódot
- SLO Za podrobna navodila za namestitve in pogoje izdelka skenirajte kodo QR
- RU Подробные инструкции по установке и условиям продукта отсканируйте QR-код.

e-mail: svc@scvgroup.cz Tel.: +420 491421021 +420 491421022 mob.: +420 603360607

© SVC GROUP s.r.o.

SK - Tažné zariadenie, GB - Towbars, PL - Haki holownicze, DE - Anhängvorrichtungen, FR - Attelages, SPA - Ganchos, HUN - Vonohorgok, RO - Cârlig de remorcare



Tažné zařízení MG ZS a ZS EV

Originál SVC GROUP s.r.o.



55R-01-638



18A6004



VTZ 001-531 A-531-2024



1000/83 D= 6,87



VTZ 002-531 A-531-2024



55R-01-0639



VTZ 003-531 AV-531-2024



1,5->2 h

2->2,5 h

M10x35 G10.9 2x

M12x35 G10.9 3x

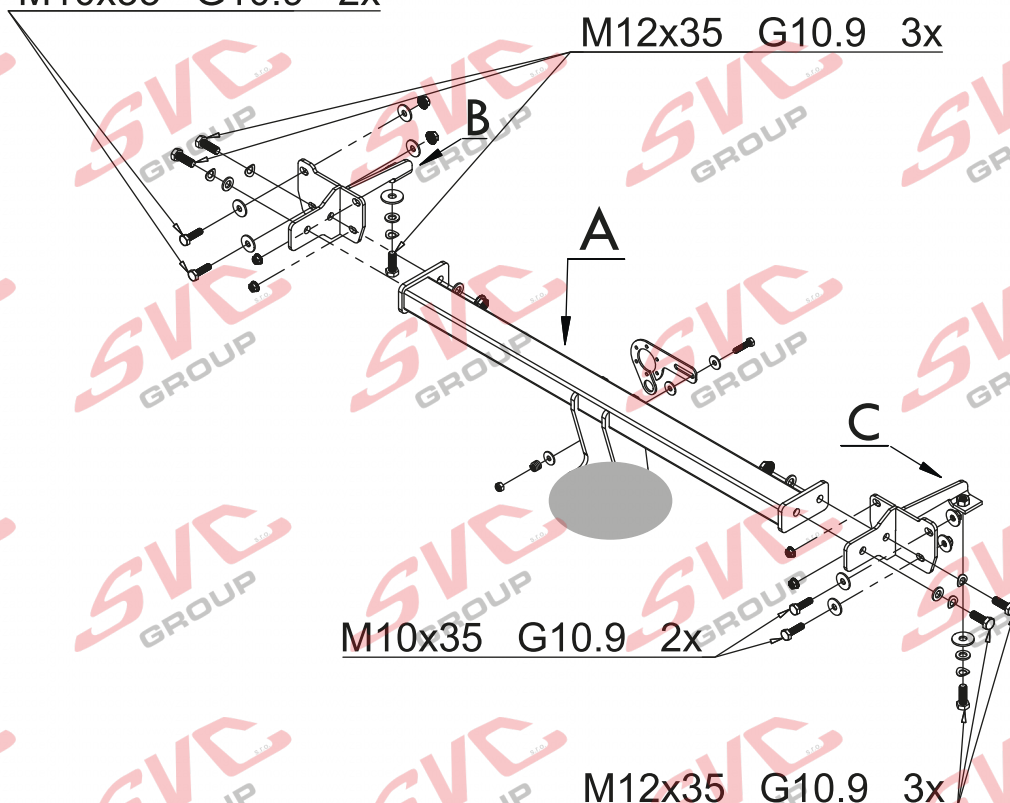

M10x35 G10.9 2x

M12x35 G10.9 3x

	A	x1		M12x35 G10.9	6ks
				M10x35 G10.9	4ks
	B	x1		Ø12	6ks
				Ø10	6ks
	C	x1		Ø12	2ks
				Ø10	6ks
				M12	2ks
				M10	6ks
				M8	4ks
Krátké					

SVC GROUP



SVC GROUP s.r.o. Průmyslová zóna - 179 547 01 Náchod-ČR

www.svcgroup.cz

e-mail: svc@svcgroup.cz

Tel.: +420 491421021

+420 491421022

mob.: +420 603360607

QR kódem si stáhnete si rozšířeny montážní návod / With QR code you can download the extended assembly instructions

SVC GROUP ©- 05/19



Tažné zařízení MG ZS a ZS EV



Montážní návod
 Montážny návod
 Installation instructions
 Installationsanleitung
 Instructions d'installation
 Инструкция по установке



55R-01-638

85

1 000

D= 6,87



kN



VTZ 001-531 A-531-2024



VTZ 002-531 A-531-2024



VTZ 003-531 AV-531-2024

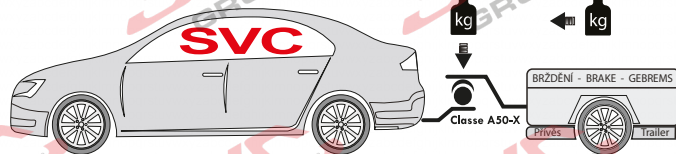

1,5->2,0 h



2->2,5 h

M10x35 G10.9 2x

M12x35 G10.9 3x

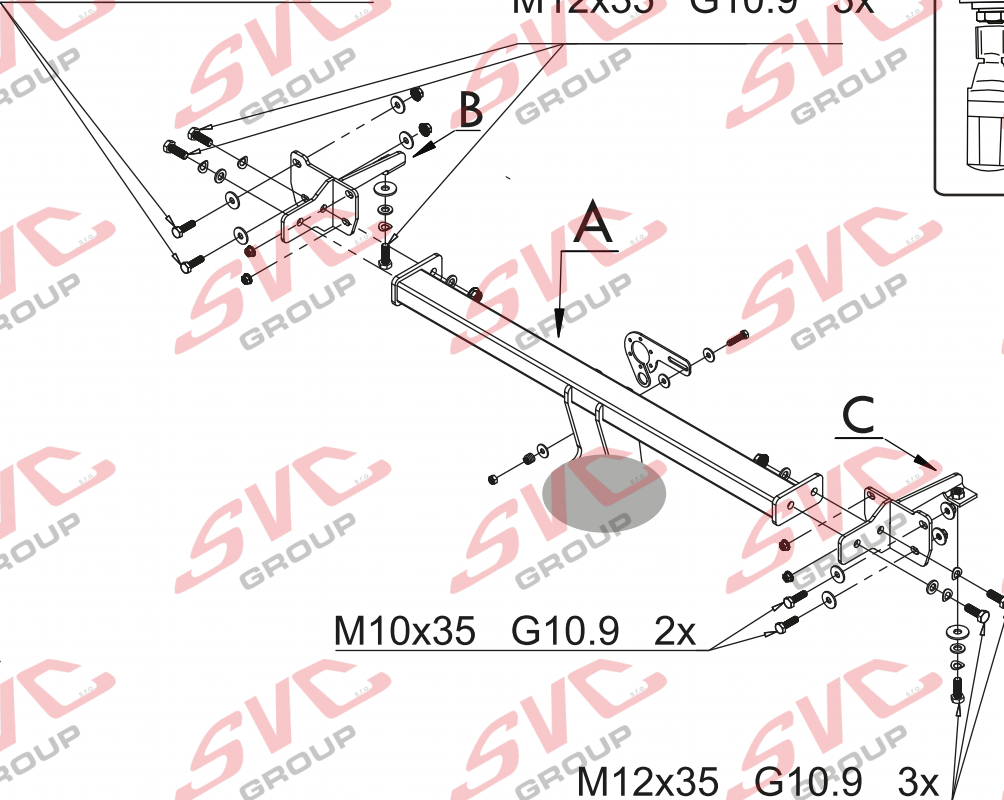
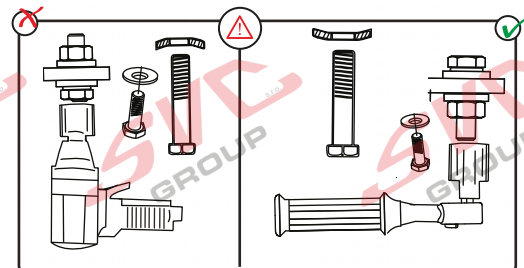

M10x35 G10.9 2x

M12x35 G10.9 3x

Max -> 1000 km 0 km

Nm

Pevnost	8,8	10,9	12,9
M6	9,7	14,3	16,1
M8	24,5	35,9	42,0
M10	48,4	71,0	83,0
M12	84,0	123,0	144,0
M14	133,0	196,0	229,0
M16	137,0	307,0	359,0

Nm

Homologace EHK 55-R

Tržní číslo

Approval Number Class **A50-X**

00-xxxx

Type: D-Value: kN

Series: Vert.Id: kg

www.svcgroup.cz - CZECH REPUBLIC

- CZ Informace k provozu / homologaci
- SK Informácie na prevádzku / homologáciu
- EN Operating / homologation information
- DE Betriebs- / Zulassungsinformationen
- HU Üzemeltetési / homologációs információk
- FR Informations d'exploitation / homologatio
- IT Informazioni sull'operazione / omologazio
- NL Monteringsanvisningar
- ES Instrucciones de montaje
- FIN Montage-instructie
- SV Asennusohjeet
- NOR Drifts- / homologasjonsinformasjon
- PL Informacje dotyczące pracy / homologacji
- RU Информация о работе / омологации



Tažné zařízení MG ZS a ZS EV

N-1

CS Montážní návod

Pro podrobné montážní instrukce a podmínky výrobku si naskenujte QR kód

1. Odmontujte zadní světla, nárazník a jeho plechovou výtuhu (tato nebude již zapotřebí). Uvolněte tepelný štít výtoku na levé straně. Odstraňte z nosníků náštřík v místě uchycení tažného zařízení.
2. Do nosníků zasuňte pravý a levý bok tažného zařízení a přichyťte k nosníkům šrouby M12 x 35 (10.9.) přes velkoplošné podložky. K zadnímu čelu přichyťte 4 šrouby M10 x 35 (10.9.) a 4 matky M8 límcové. Nedotahujte!
3. Namontujte hlavní nosník tažného zařízení 4 šrouby M12 x 35 (10.9.). Poté vše vyrovnejte a dotáhněte dle utahovacích momentů.
4. Namontujte zpět všechny díly odmontované v bodě č. 1.

EN Installation instructions

For detailed installation instructions and product conditions, scan the QR code

1. Remove the rear lights, bumper and its sheet metal reinforcement (this will no longer be needed). Release the heat shield on the left side. Remove the spray from the beams where the towing bracket attaches.
2. Insert the right and left sides of the towing bracket into the beams and attach to the beams with M12 x 35 bolts (10.9) through the large washers. Attach 4 M10 x 35 (10.9.) bolts and 4 M8 collar nuts to the rear face. Do not tighten!
3. Fit the main towing bracket with 4 M12 x 35 screws (10.9.). Then align everything and tighten according to the tightening torques.
4. Refit all parts removed in step 1.

SK Montážny návod

Pre podrobné montážne pokyny a podmienky produktu si môžete skenovať QR kód

1. Odstranite zadnje luči, odbijač in njegovo pločevinasto ojačitev (ta ne bo več potrebna). Sprostite toplotni ščit na levi strani. Z nosilcev, na katerih je pritrjen nosilec za vleko, odstranite sprej.
2. Desno in levo stran nosilca za vleko vstavite v nosilce in jih pritrdite z vijaki M12 x 35 (10.9) skozi velike podložke. Na zadnjo stran pritrdite 4 vijake M10 x 35 (10.9.) in 4 obojne matice M8. Ne zategujte!
3. S 4 vijaki M12 x 35 (10.9.) pritrdite glavni nosilec za vleko. Nato vse skupaj poravnajte in zategnite v skladu z zategovalnimi momenti.
4. Ponovno namestite vse dele, ki so bili odstranjeni v koraku 1.

DE Montageanleitung

Scannen Sie den QR-Code, um detaillierte Installationsanweisungen und Produktbedingungen zu erhalten

1. Entfernen Sie die Rückleuchten, die Stoßstange und deren Blechverstärkung (diese wird nicht mehr benötigt). Lösen Sie das Hitzeschild auf der linken Seite. Entfernen Sie das Spray von den Trägern, an denen die Abschlepphalterung befestigt ist.
2. Setzen Sie die rechte und linke Seite der Abschleppkonsole in die Träger ein und befestigen Sie sie mit Schrauben M12 x 35 (10.9) durch die großen Unterlegscheiben an den Trägern. Befestigen Sie 4 Schrauben M10 x 35 (10.9.) und 4 Bundmuttern M8 an der Rückwand. Nicht festziehen!
3. Montieren Sie die Hauptzugvorrichtung mit 4 Schrauben M12 x 35 (10.9.). Anschließend alles ausrichten und gemäß den Anzugsdrehmomenten anziehen.
4. Montieren Sie alle in Schritt 1 entfernten Teile wieder. Montieren Sie den Sensor an der Zugvorrichtung mit den Zugstangen, machen Sie den Ausschnitt entsprechend der Abbildung und dem Typ der Zugvorrichtung und montieren Sie alle in Punkt 1 entfernten Teile wieder.

PL Instrukcja montażu

Aby uzyskać szczegółowe instrukcje instalacji i warunki produktu, zeskanuj kod QR

1. Zdemontować tylne światła, zderzak i jego blaszane wzmocnienie (nie będzie już potrzebne). Zdejmij osłonę termiczną po lewej stronie. Usuń spray z belek, do których przymocowany jest hak holowniczy.
2. Włóż prawą i lewą stronę wspornika holowniczego do belek i przymocuj do belek śrubami M12 x 35 (10.9) przez duże podkładki. Przymocuj 4 śruby M10 x 35 (10.9.) i 4 nakrętki kołnierzykowe M8 do tylnej ściany. Nie dokręcać!
3. Zamontować główny wspornik holowniczy za pomocą 4 śrub M12 x 35 (10.9.). Następnie wyrównaj wszystko i dokręć zgodnie z momentami dokręcania.
4. Ponownie zamontuj wszystkie części zdemontowane w kroku 1.

FR Notice de montage

Pour des instructions d'installation détaillées et les conditions du produit, scannez le code QR

1. Retirer les feux arrière, le pare-chocs et son renfort en tôle (il ne sera plus nécessaire). Dégager le bouclier thermique sur le côté gauche. Enlever le spray sur les poutres où se fixe le support d'attelage.
2. Insérez les côtés droit et gauche du support de remorquage dans les poutres et fixez-les avec des boulons M12 x 35 (10.9) à travers les grandes rondelles. Fixez 4 boulons M10 x 35 (10.9.) et 4 écrous à collet M8 à la face arrière. Ne pas serrer !
3. Montez le support de remorquage principal avec 4 vis M12 x 35 (10.9.). Ensuite, alignez tout et serrez selon les couples de serrage.
4. Remonter toutes les pièces retirées à l'étape 1.

FI Asennusohje

Tarkemmat asennusohjeet ja tuotteen ehdot on tarkistettava QR-koodilla

1. Irrota takavalot, puskuri ja sen peltivahvike (tätä ei enää tarvita). Irrota vasemmanpuoleinen lämpösuoja. Poista ruisku palkeista, joihin hinauskiinnike kiinnittyy.
2. Työnnä hinauskiinnikkeen oikea ja vasen puoli palkkien sisään ja kiinnitä palkkeihin M12 x 35 -pulteilla (10.9) suurten aluslevyjen läpi. Kiinnitä 4 M10 x 35 (10.9.) pulttia ja 4 M8-kaulamutteria takapintaan. Älä kiristä!
3. Asenna päävetokannatin 4 ruuvilla M12 x 35 (10.9.). Kohdista sitten kaikki ja kiristä kiristysmomenttien mukaisesti.
4. Asenna kaikki vaiheessa 1 poistetut osat takaisin paikalleen.



SVC GROUP s.r.o. Průmyslová zóna - 179 547 01 Náchod-ČR

www.svcgroup.cz
e-mail: svc@svcgroup.cz

Tel.: +420 491421021
+420 491421022
mob.: +420 603360607

QR kódem stáhnete rozšířený montážní návod / With QR code you can download the extended assembly instructions

SVC GROUP ©- 05/19



Tažné zařízení MG ZS a ZS EV

N-1

ES Manual de montaje

Para obtener instrucciones detalladas de instalación y condiciones del producto, escanee el código QR

1. Retire las luces traseras, el parachoques y su refuerzo de chapa (ya no será necesario). 2. Soltar el escudo térmico del lado izquierdo. Quitar el spray de las vigas donde se sujeta el soporte de remolque.
2. Inserte los lados derecho e izquierdo del soporte de remolque en los largueros y fíjelos con tornillos M12 x 35 (10.9) a través de las arandelas grandes.
3. Fije 4 pernos M10 x 35 (10.9.) y 4 tuercas de collarín M8 a la cara posterior. No apriete.
3. Coloque el soporte de remolque principal con 4 tornillos M12 x 35 (10.9.). Luego alinee todo y apriete según los pares de apriete.
4. Vuelva a montar todas las piezas desmontadas en el paso 1.

IT Istruzioni di montaggio per la

Per istruzioni di installazione dettagliate e condizioni del prodotto, eseguire la scansione del codice QR

1. Rimuovere le luci posteriori, il paraurti e il relativo rinforzo in lamiera (non sarà più necessario). Sganciare lo scudo termico sul lato sinistro. Rimuovere lo spray dalle travi dove si attacca la staffa di traino.
2. Inserire i lati destro e sinistro della staffa di traino nelle travi e fissarli con i bulloni M12 x 35 (10.9) attraverso le rondelle grandi. Fissare 4 bulloni M10 x 35 (10.9.) e 4 dadi a collare M8 alla parte posteriore. Non serrare!
3. Montare la staffa di traino principale con 4 viti M12 x 35 (10.9.). Allineare quindi il tutto e serrare secondo le coppie di serraggio.
4. Rimontare tutte le parti rimosse al punto 1.

NO Monteringsanvisning

For installasjonsinstruksjoner og produktbetingelser, skann QR-koden

1. Fjern baklyktene, støtfangeren og metallforsterkningen (dette er ikke lenger nødvendig). Løsne varmeskjoldet på venstre side. Fjern sprayen fra bjelkene der hengerfestet festes.
2. Sett inn høyre og venstre side av tilhengerfestet i bjelkene og fest det til bjelkene med M12 x 35-bolter (10.9) gjennom de store skivene. Fest 4 bolter M10 x 35 (10.9.) og 4 muttere M8 på baksiden. Ikke trekk til!
3. Monter hovedtilhengerfestet med 4 skruer M12 x 35 (10.9.). Juster deretter alt og trekk til i henhold til tiltrekkingsmomentene.
4. Monter alle delene som ble fjernet i trinn 1.

NL Montagehandleiding

Scan de QR-code voor installatie-instructies en instructies voor productcondities

1. Verwijder de achterlichten, de bumper en de plaatversterking (deze zijn niet meer nodig). Maak het hitteschild aan de linkerkant los. Verwijder de spray van de balken waar de trekhaak aan vastzit.
2. Steek de rechter- en linkerkant van de trekhaak in de balken en bevestig aan de balken met M12 x 35 bouten (10.9) door de grote ringen. Bevestig 4 M10 x 35 (10.9.) bouten en 4 M8 kraagmoeren aan de achterkant. Niet vastdraaien!
3. Monteer de hoofd draagbeugel met 4 M12 x 35 bouten (10.9.). Lijn vervolgens alles uit en draai vast volgens de aandraaimomenten.
4. Monteer alle in stap 1 verwijderde onderdelen.

HU Szerelési útmutató

A telepítési és a termékfeltételekkel kapcsolatos utasításokat olvassa be a QR-kódot

1. Távolítsa el a hátsó lámpákat, a lökhárítót és annak lemezmege erősítését (erre már nem lesz szükség). Oldja ki a bal oldali hővédő pajzsot. Távolítsa el a spray-t a gerendákról, ahol a vonóhorog rögzül.
2. Illesse a vonóhorog jobb és bal oldalát a gerendákba, és a nagy alátéteken keresztül M12 x 35 csavarokkal (10.9) rögzítse a gerendákhoz. Csatlakoztasson 4 db M10 x 35 (10.9.) csavart és 4 db M8-as galléranycát a hátsó oldalhoz. Ne húzza meg!
3. Szerelje fel a fő vontatási konzolt 4 M12 x 35 csavarral (10.9.). Ezután igazítson ki mindent, és húzza meg a meghúzási nyomtatóknak megfelelően.
4. Szerelje vissza az 1. lépésben eltávolított összes alkatrészt.

RU Инструкция по монтажу

Подробные инструкции по установке и условиям продукта отсканируйте QR-к

1. Снимите задние фонари, бампер и его усиление из листового металла (оно больше не понадобится). Освободите теплозащитный экран с левой стороны. Снимите напыление с балки, где крепится буксировочный кронштейн.
2. Вставьте правую и левую стороны буксировочного кронштейна в балки и закрепите их болтами M12 x 35 (10.9) через большие шайбы. Прикрепите 4 болта M10 x 35 (10.9.) и 4 воротниковые гайки M8 к задней поверхности. Не затягивайте!
3. Установите основной буксировочный кронштейн с помощью 4 болтов M12 x 35 (10.9.). Затем все выровняйте и затянуть в соответствии с моментами затяжки.
4. Установите на место все детали, снятые на шаге 1.



SVC GROUP s.r.o. Průmyslová zóna - 179
547 01 Náchod-ČR

www.svcgroup.cz
e-mail: svc@svcgroup.cz

Tel.: +420 491 421 021
+420 491 421 022
mob.: +420 603 360 607

SVC GROUP ©- 05/19

QR kódem stáhnete rozšířený montážní návod / Verwenden Sie den QR-Code, um die erweiterte Montageanleitung herunterzuladen



1.

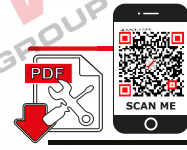
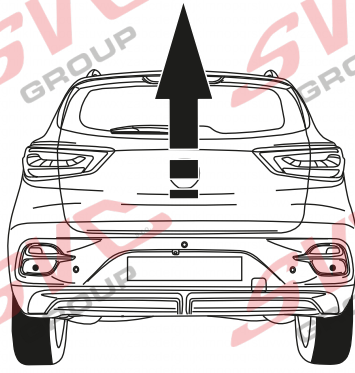

Montážní návod
Montážny návod
Installation instructions
Installationsanleitung
Instructions d'installation
Инструкция по установке



2.

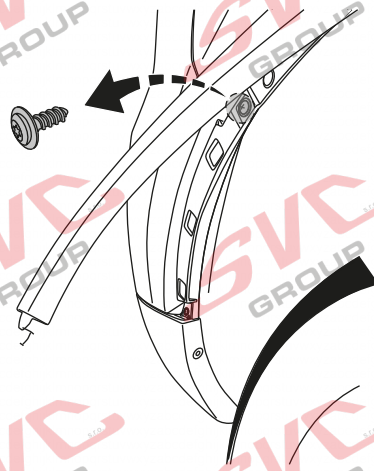
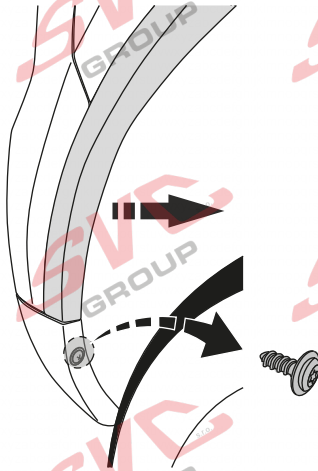
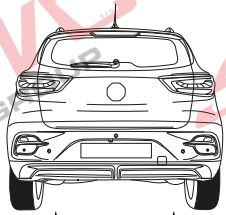

PH2



3.

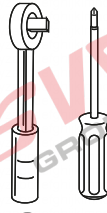
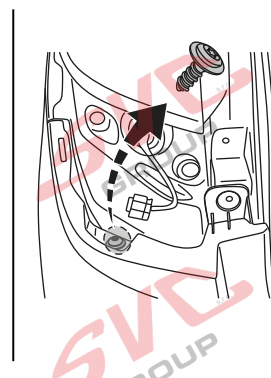
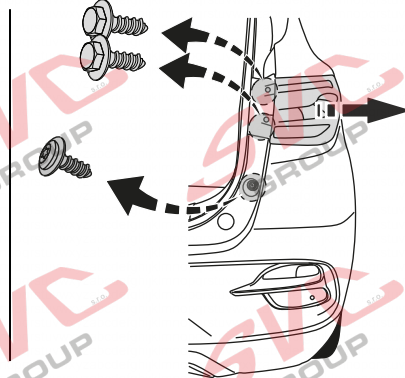
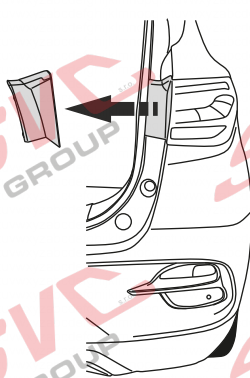
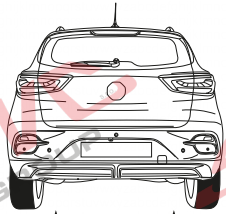

10 PH2



4.

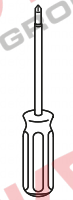
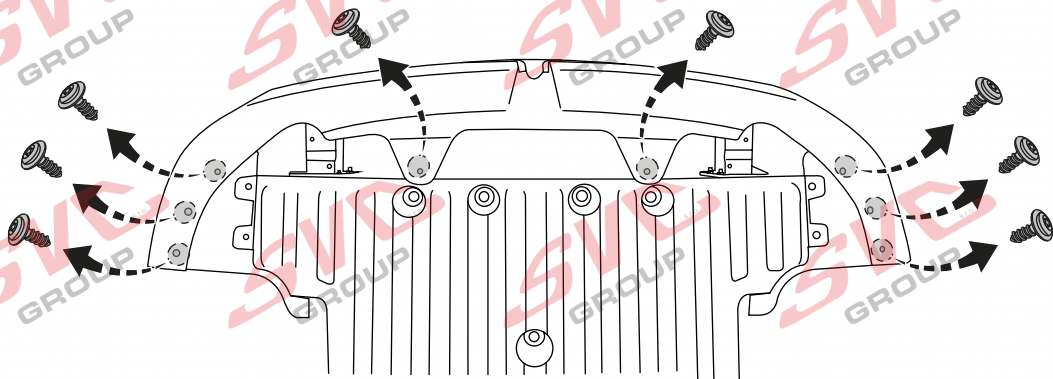
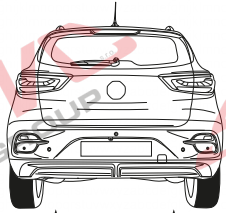

PH2

SVC GROUP ©-4014



SVC GROUP s.r.o. Průmyslová zóna - 179 547 01 Náchod-ČR

www.svcgroup.cz e-mail: svc@svcgroup.cz

Tel.: +420 491421021 +420 491421022 mob.: +420 603360607

QR kódem stáhnete rozšířeny montážní návod / Met QR-code kunt u de uitgebreide montage-instructies downloaden

SVC GROUP ©- 05/19



5.

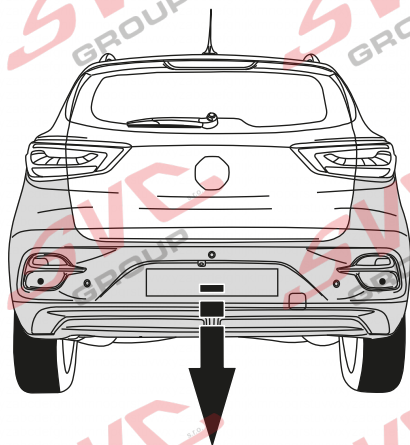
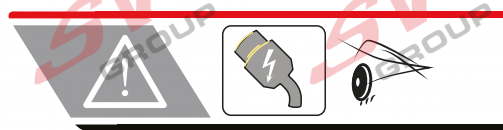

6.

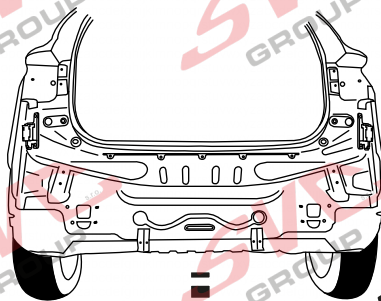

13



7.

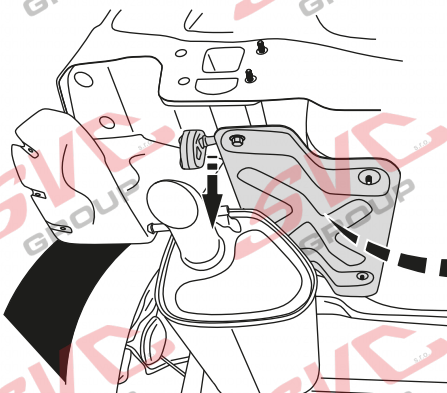
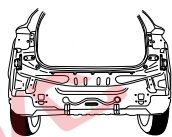

8.

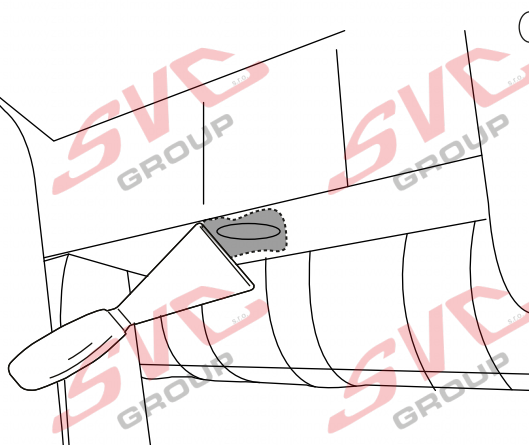
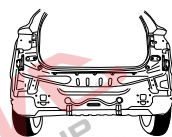

9.

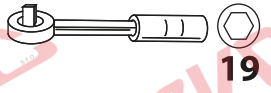
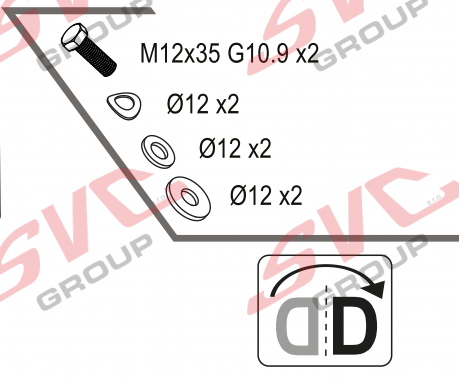
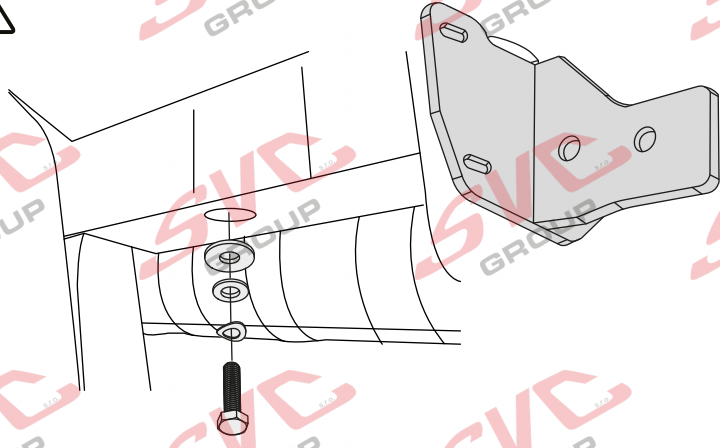
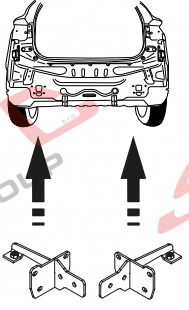

10.

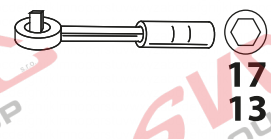
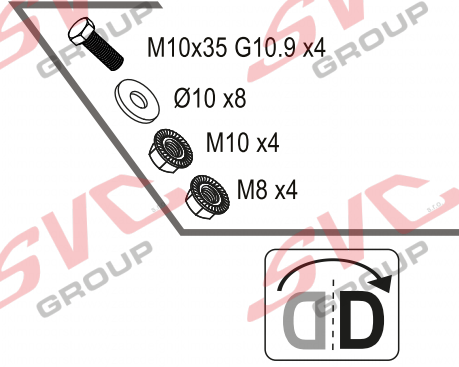
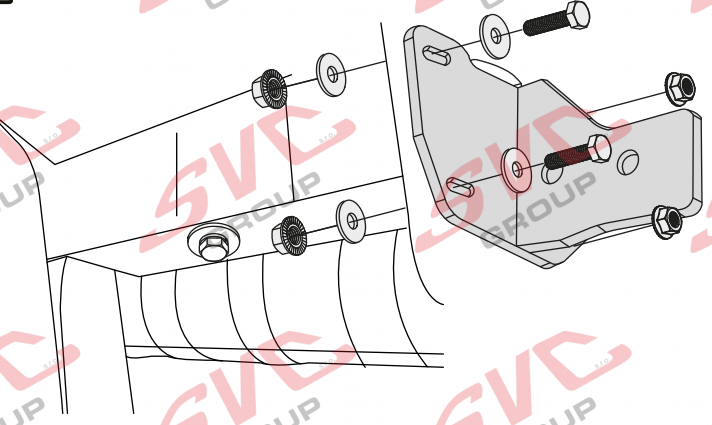
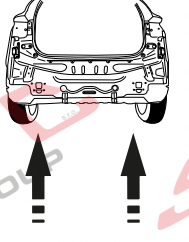

11.

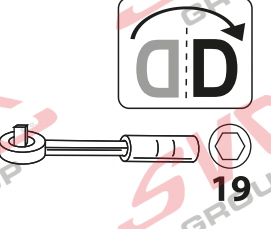
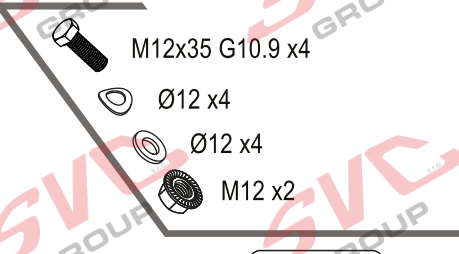
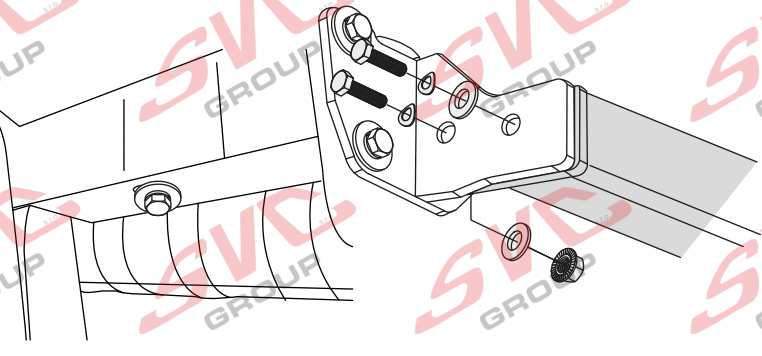
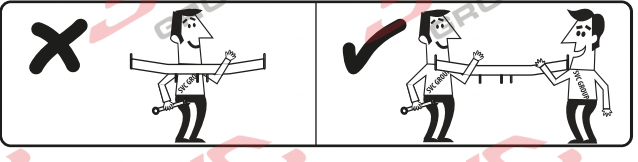
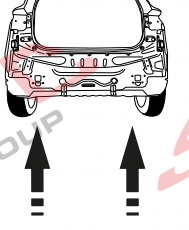

12.

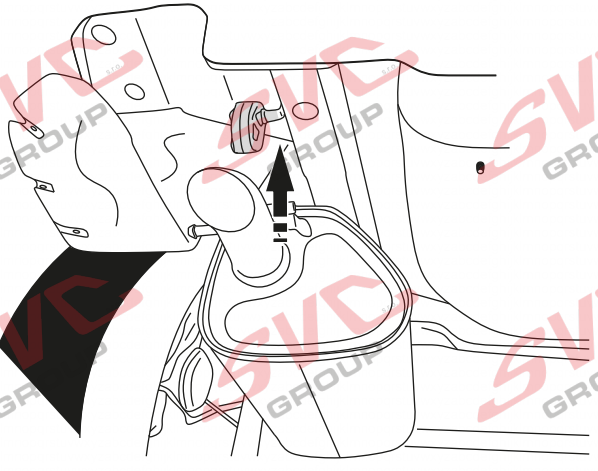
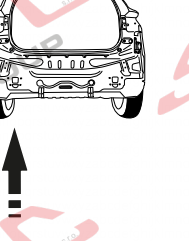



12.

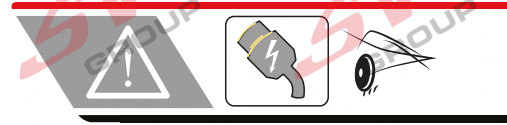
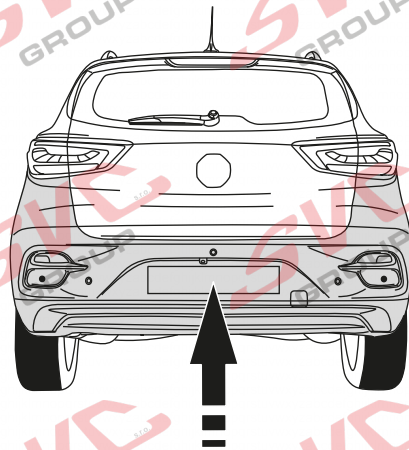

13.

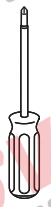
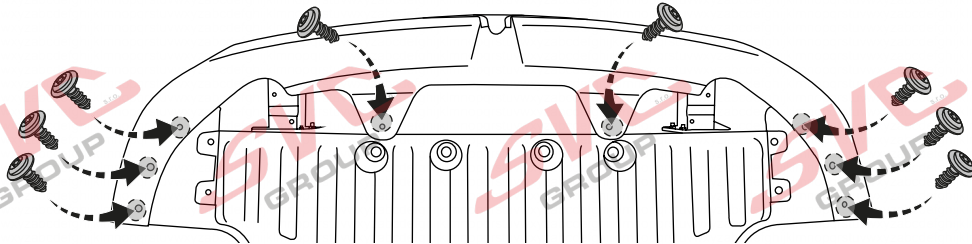
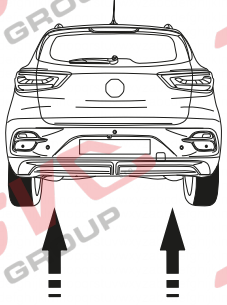

PH2



14.

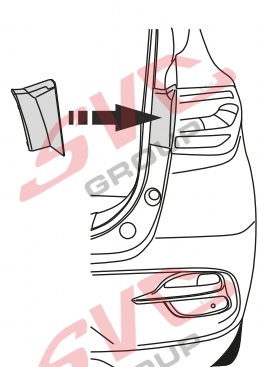
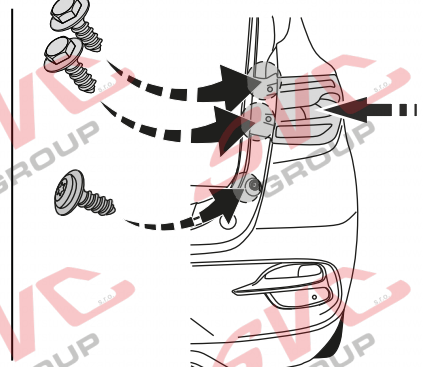
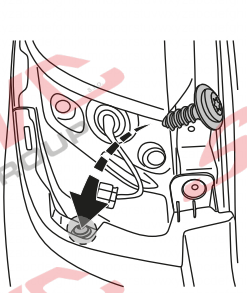
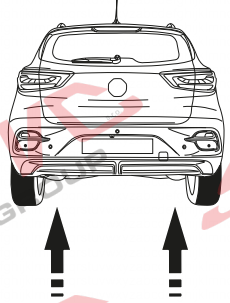
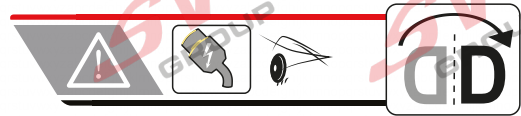

10 PH2



15.

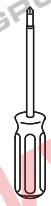
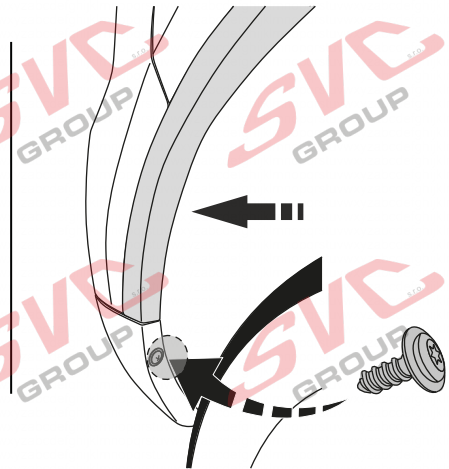
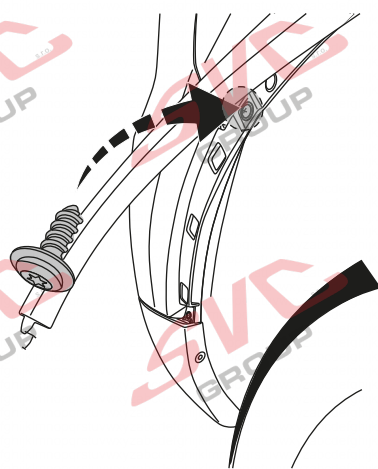
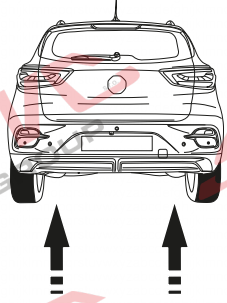

PH2



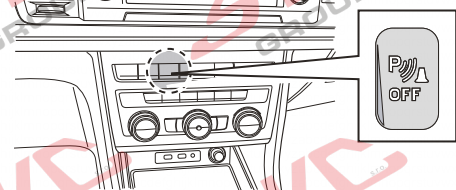
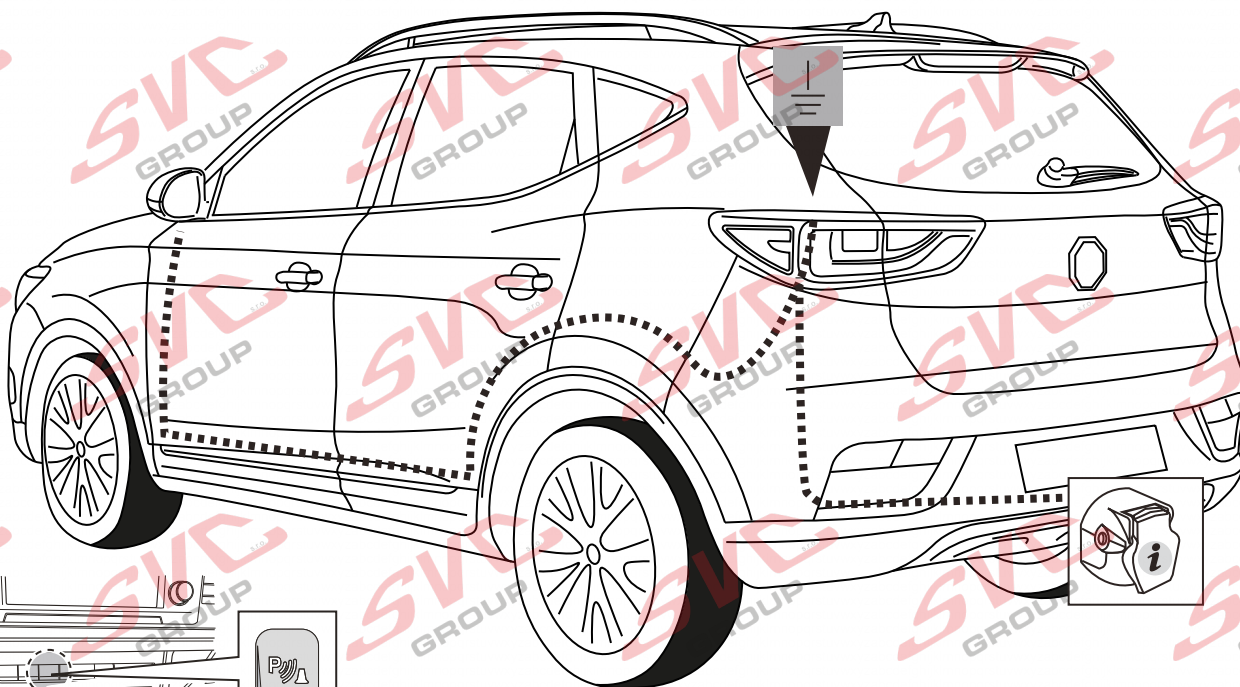

Informace pro odpojování couvacích senzorů PDC pro tažné zařízení

Vypínač pro vypínání couvacích senzorů PDC je umístěný na palubní desce vozu.

Nemusíte tedy pracně na elektro instalaci vozu napojovat odpojování couvacích senzorů PDC a zpětných kamer od elektro přípojky tažných zařízení.

Pokud chcete senzory vypnout, použijte vypínač na palubní desce.

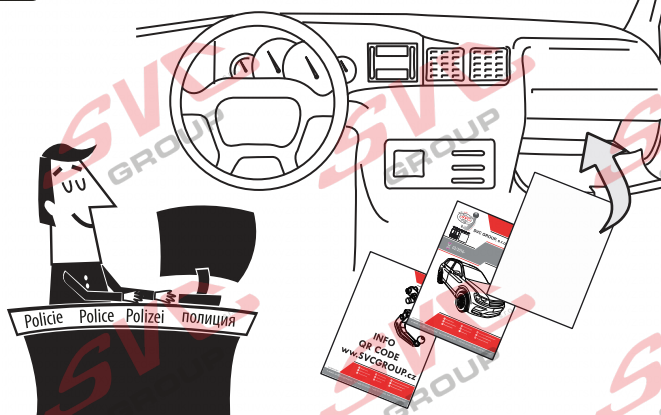

SVC GROUP

Děkuje za důvěru / Āakuje za dōvěru

Thank you for your trust / Danke Für dein Vertrauen

Merci pour votre conance / Grazie per la tua ducia

Tankewol foar jo fertrouwen / Спасибо за vaše dōvěrie

Registrace / Registračia

Registration / Registrierung

Inscription / Registrazone

Rekisterōinti / Регистрация

SVC GROUP ©- 15/2020



SVC GROUP s.r.o. Průmyslová zóna - 179
547 01 Náchod-ČR

www.svcgroup.cz

e-mail: svc@svcgroup.cz

Tel.: +420 491421021

+420 491421022

mob.: +420 603360607

SVC GROUP ©- 05/19

QR kódem stáhnete rozšířený montážní návod / QR kódem stiahnete rozšírené montážny návod



T-1

CZ Informace k provozu / homologaci

Výrobek je vyráběn dle platných norem EHK-55 R pro prodej ve státech EU. Informace pro použití, provoz a záruky pro tažné zařízení naleznete na našem webu, www.svcgroup.cz

Technické informace > Tažné zařízení > Všeobecné podmínky použití výrobku. Nebo si je stáhněte aplikace přes přiložený QR-cod

Součástí dodávky tažného zařízení je dodán TYPOVÝ LIST. Tento typový list slouží pro zapsání výrobku do technického průkazu vozidla, a obsahuje základní podmínky pro použití výrobku.

Typový list slouží i jako záruční lis proto jej uschovejte v dokumentaci vozidla.

SK Informácie na prevádzku / homologáciu

Výrobok je vyrábaný podľa platných noriem EHK-55 R pre predaj v štátoch EÚ. Informácie pre použitie, prevádzku a záruky pre ťažné zariadenie nájdete na našom webe, www.svcgroup.cz

Technické informácie > Ťažné zariadenie > Všeobecné podmienky použitia výrobku. Alebo si ich stiahnite aplikácie cez priložený QR-cod

Súčasťou dodávky ťažného zariadenia je dodaný TYPOVÝ LIST. Tento typový list slúži pre zapísanie výrobku do technického preukazu vozidla, a obsahuje základné podmienky použitia výrobku.

Typový list slúži aj ako záručný lis preto ho uschovajte v dokumentácii vozidla.

EN Operating / homologation information

The product is manufactured according to the applicable EHK-55 R standards for sale in EU countries. Information on the use, operation and warranties for the towbar can be found on our website, www.svcgroup.com

Technical information > Towing hitch > General conditions of use. Or download them via QR-cod

The towing device is supplied with a TYPE SHEET. This data sheet is used to enter the product in the vehicle registration document and contains the basic conditions for use of the product.

The data sheet also serves as a warranty press, so keep it in the vehicle documentation.

DE Betriebs / Zulassungsinformationen

Das Produkt wird gemäß den geltenden EHK-55 R-Standards für den Verkauf in EU-Ländern hergestellt. Informationen zu Verwendung, Betrieb und Gewährleistung der Anhängerkupplung finden Sie auf unserer Website www.svcgroup.com

Technische Informationen > Anhängerkupplung > Allgemeine Nutzungsbedingungen. Oder laden Sie sie per QR-Code herunter

Die Anhängervorrichtung wird mit einem TYPENBLATT geliefert. Dieses Datenblatt dient zur Eintragung des Produkts in das Kfz-Kennzeichen und enthält die Grundbedingungen für die Verwendung des Produkts. Das Datenblatt dient auch als Garantiepresse. Bewahren Sie es daher in der Fahrzeugdokumentation auf.

HU Üzemeltetési / homologációs információk

Das Produkt wird gemäß den geltenden EHK-55 R-Standards für den Verkauf in EU-Ländern hergestellt. Informationen zu Verwendung, Betrieb und Gewährleistung der Anhängerkupplung finden Sie auf unserer Website www.svcgroup.com

Technische Informationen > Anhängerkupplung > Allgemeine Nutzungsbedingungen. Oder laden Sie sie per QR-Code herunter

Die Anhängervorrichtung wird mit einem TYPENBLATT geliefert. Dieses Datenblatt dient zur Eintragung des Produkts in das Kfz-Kennzeichen und enthält die Grundbedingungen für die Verwendung des Produkts. Das Datenblatt dient auch als Garantiepresse. Bewahren Sie es daher in der Fahrzeugdokumentation auf.

FR Informations d'exploitation / homologation

Le produit est fabriqué conformément aux normes EHK-55 R applicables pour la vente dans les pays de l'UE. Des informations sur l'utilisation, le fonctionnement et les garanties de l'attelage sont disponibles sur notre site Web, www.svcgroup.com.

Informations techniques > Attelage de remorquage > Conditions générales d'utilisation. Ou téléchargez-les via QR-cod

Le dispositif de remorquage est fourni avec une feuille de type. Cette fiche technique est utilisée pour entrer le produit dans le certificat d'immatriculation du véhicule et contient les conditions de base pour l'utilisation du produit. La fiche technique sert également de presse de garantie, conservez-la dans la documentation du véhicule.

IT Informazioni sull'operazione / omologazione

Il prodotto è fabbricato secondo le norme EHK-55 R applicabili in vendita nei paesi dell'UE. Informazioni sull'uso, il funzionamento e le garanzie per il gancio di traino sono disponibili sul nostro sito Web www.svcgroup.com

Informazioni tecniche > Gancio di traino > Condizioni generali d'uso. Oppure scaricali tramite QR-cod

Il dispositivo di rimorchio viene fornito con una SCHEDA TIPO. Questa scheda tecnica viene utilizzata per inserire il prodotto nel certificato di immatricolazione del veicolo e contiene le condizioni di base per l'uso del prodotto. La scheda tecnica funge anche da stampa di garanzia, quindi conservala nella documentazione del veicolo.



SVC GROUP s.r.o. Průmyslová zóna - 179
547 01 Náchod-ČR

www.svcgroup.cz
e-mail: svc@svcgroup.cz

Tel.: +420 491421021
+420 491421022
mob.: +420 603360607

QR kódem stáhněte rozšířený montážní návod / QR-kóddal letöltheti a kibővített összeszerelési utasításokat

SVC GROUP ©- 05/19



T-2

NL Monteringsanvisningar

Het product is vervaardigd volgens de toepasselijke EHK-55 R-normen voor verkoop in EU-landen. Informatie over het gebruik, de werking en de garanties voor de trekhaak vindt u op onze website, www.svcgroup.com *Technische informatie* > *Trekhaak* > *Algemene gebruiksvoorwaarden*. Of download ze via QR-cod
Het sleepapparaat wordt geleverd met een TYPE BLAD. Dit gegevensblad wordt gebruikt om het product in het voertuigregistratiedocument in te voeren en bevat de basisvoorwaarden voor het gebruik van het product. Het gegevensblad dient ook als garantiepers, dus bewaar het in de voertuigdocumentatie.

ES Instrucciones de montaje

El producto se fabrica de acuerdo con los estándares EHK-55 R aplicables para la venta en países de la UE. Puede encontrar información sobre el uso, el funcionamiento y las garantías de la barra de remolque en nuestro sitio web, www.svcgroup.com *Información técnica* > *Enganche de remolque* > *Condiciones generales de uso*. O descárguelos a través de QR-cod
El dispositivo de remolque se suministra con una HOJA DE TIPO. Esta hoja de datos se utiliza para ingresar el producto en el documento de registro del vehículo y contiene las condiciones básicas para el uso del producto. La hoja de datos también sirve como una prensa de garantía, por lo tanto, consérvela en la documentación del vehículo.

FIN Montage-instructie

Tuote on valmistettu EU-maissa myytävien EHK-55 R-standardien mukaisesti. Tietoja vetokoukun käytöstä, käytöstä ja takuista löytyy verkkosivuiltamme www.svcgroup.com *Tekniset tiedot* > *Vetokoukku* > *Yleiset käyttöohjeet*. Tai lataa ne QR-koodin kautta
Hinauslaite toimitetaan TYYPPI-ARKKI. Tätä lomaketta käytetään tuotteen syöttämiseen ajoneuvon rekisteröintitodistukseen, ja se sisältää tuotteen käytön perusedellytykset. Tietolomake toimii myös takuupuristimena, joten säilytä se ajoneuvon dokumenteissa.

SL

Izdelek je izdelan po veljavnih standardih EHK-55 R za prodajo v državah EU. Informacije o uporabi, delovanju in garancijah za vlečno ploščo najdete na našem spletnem mestu www.svcgroup.com *Tehnični podatki* > *Vlečna kljuka* > *Splošni pogoji uporabe*. Ali pa jih prenesite preko QR-kod
Vlečna naprava je opremljena s TIPNIM LISTOM. Ta podatkovni list se uporablja za vnos izdelka v registracijski dokument vozila in vsebuje osnovne pogoje za uporabo izdelka. Podatkovni list služi tudi kot garancijski tisk, zato ga hranite v dokumentaciji vozila.

NOR Drifts- / homologasjonsinformasjon

Produktet er produsert i henhold til gjeldende EHK-55 R standarder for salg i EU-land. Informasjon om bruk, drift og garantier for tilhengerfeste finner du på vår hjemmeside, www.svcgroup.com
Teknisk informasjon > *Tilhengerfeste* > *Generelle bruksbetingelser*. Eller last dem ned via QR-koding
Tøeanordningen leveres med TYPEBLAD. Dette databladet brukes til å oppgi produktet i kjøretøyets registreringsbevis og inneholder de grunnleggende betingelsene for bruk av produktet. Databladet fungerer også som garantipresse, så hold det i bilens dokumentasjon.

PL Informacje dotyczące pracy / homologacji

Produkt jest wytwarzany zgodnie z obowiązującymi normami EHK-55 R na sprzedaż w krajach UE. Informacje na temat użytkowania, obsługi i gwarancji na hak holowniczy można znaleźć na naszej stronie internetowej www.svcgroup.com *Informacje techniczne* > *Zacpek holowniczy* > *Ogólne warunki użytkowania*. Lub pobierz je za pomocą kodu QR
Urządzenie holownicze jest dostarczane z ARKUSZEM TYPU. Ta karta danych służy do wpisania produktu do dokumentu rejestracyjnego pojazdu i zawiera podstawowe warunki użytkowania produktu. Karta danych służy również jako prasa gwarancyjna, dlatego przechowuj ją w dokumentacji pojazdu.

RU Информация о работе / омологации

El producto se fabrica de acuerdo con los estándares EHK-55 R aplicables para la venta en países de la UE. Puede encontrar información sobre el uso, el funcionamiento y las garantías de la barra de remolque en nuestro sitio web, www.svcgroup.com
Información técnica > *Enganche de remolque* > *Condiciones generales de uso*. O descárguelos a través de QR-cod
El dispositivo de remolque se suministra con una HOJA DE TIPO. Esta hoja de datos se utiliza para ingresar el producto en el documento de registro del vehículo y contiene las condiciones básicas para el uso del producto. La hoja de datos también sirve como una prensa de garantía, por lo tanto, consérvela en la documentación del vehículo.



SVC GROUP s.r.o. Průmyslová zóna - 179 471 01 Náchod-ČR

www.svcgroup.cz
e-mail: svc@svcgroup.cz

Tel.: +420 491 421 021
+420 491 421 022
mob.: +420 603 360 607

QR kódom stáhnete rozšírený montážní návod / Con il codice QR è possibile scaricare le istruzioni di assemblaggio estese

SVC GROUP ©- 05/19



CZ Pozor informace k záruce
SK Pozor informácie k záruke
EN Note the warranty information
DE Beachten Sie die Garantieinformationen

HU Vegye gyelembe a jótállási információkat
FR Notez les informations de garantie
IT Nota le informazioni sulla garanzia
NL Let op de garantie-informatie

ES Atención
FIN Huomio
PL Uwaga
RU Внимание

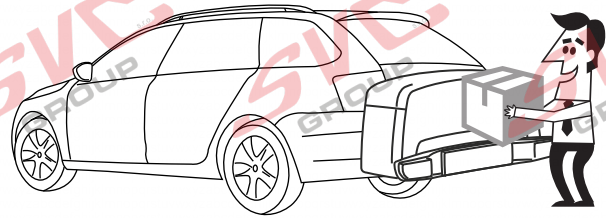
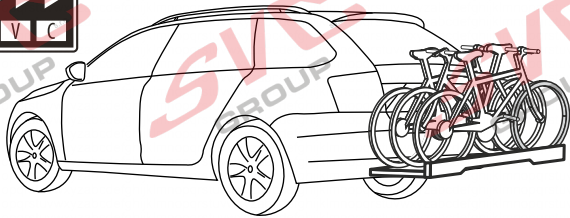

VTZ 001-531
VTZ 003-531

VTZ 002-531



3
max.

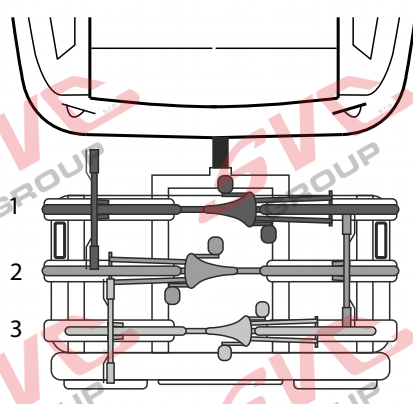

max. manual

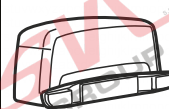
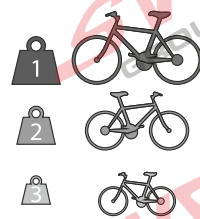

max. manual

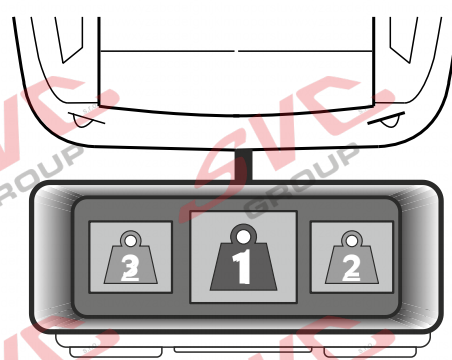

MAX.
5 km/h

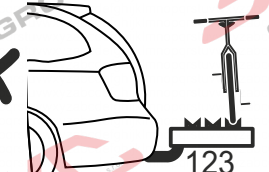
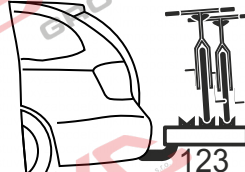
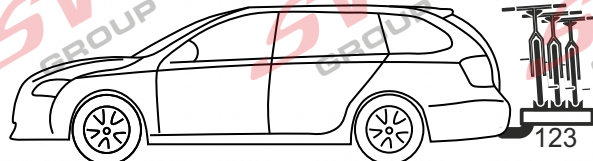
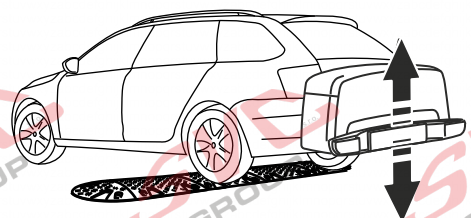
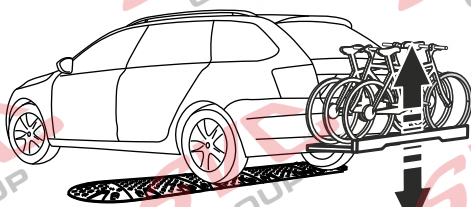

Vysokov 179
 547 01 Náchod, Česká Republika

+420 603 360 607 +420 491421021



www.svcgroup.cz



CZ Pozor informace k záruce

SK Pozor informácie k záruce

EN Note the warranty information

DE Beachten Sie die Garantieinformationen

HU Vegye gyelembe a jótállási információkat

FR Notez les informations de garantie

IT Nota le informazioni sulla garanzia

NL Let op de garantie-informatie

ES Atención

FIN Huomio

PL Uwaga

RU Внимание

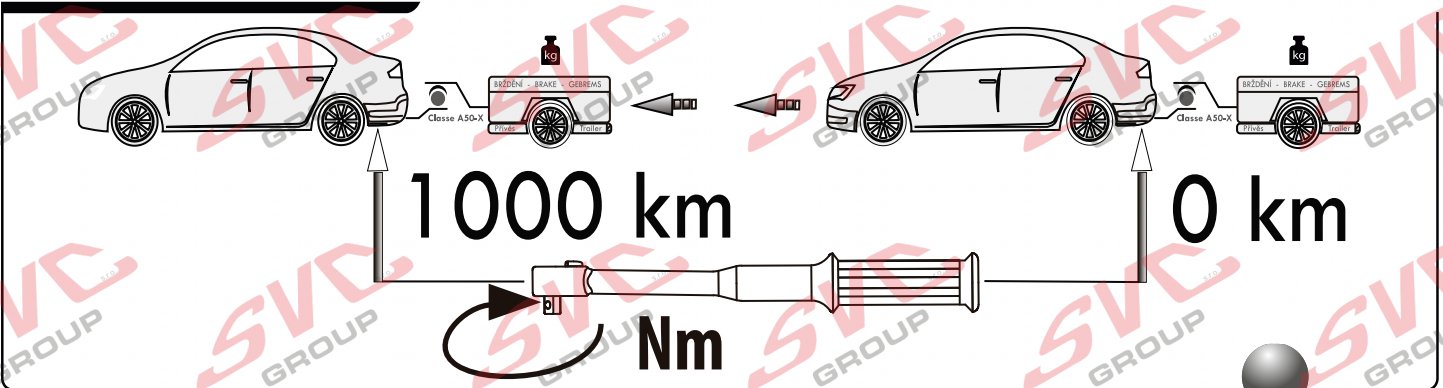
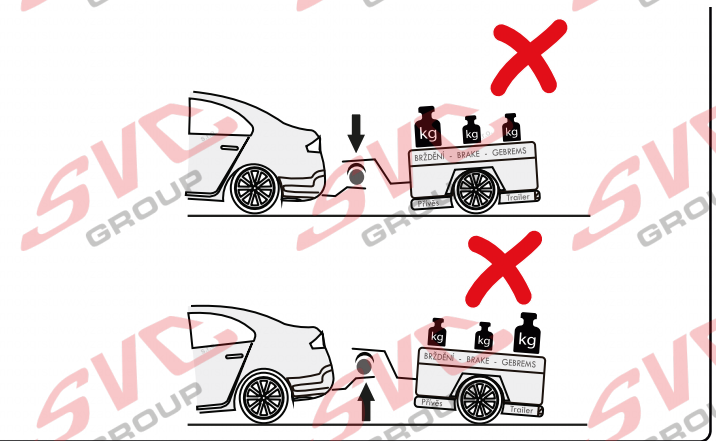
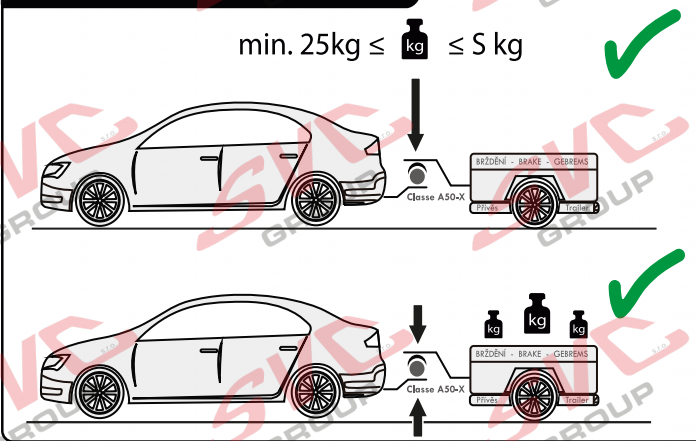
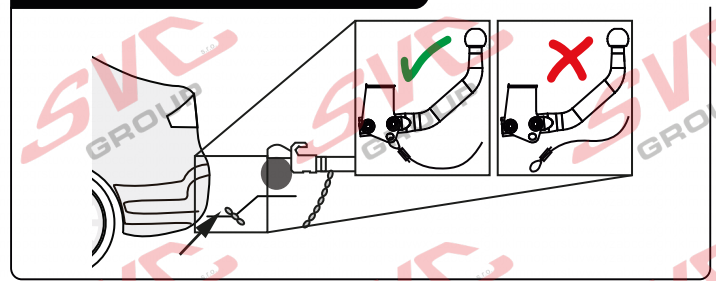
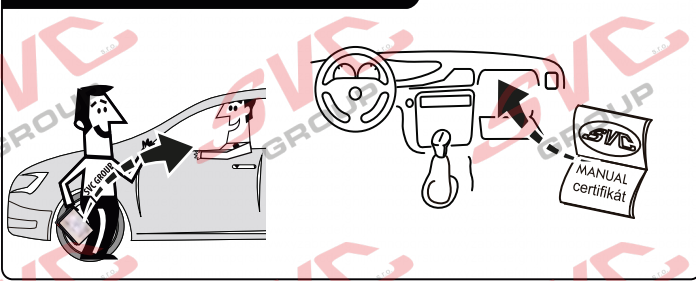
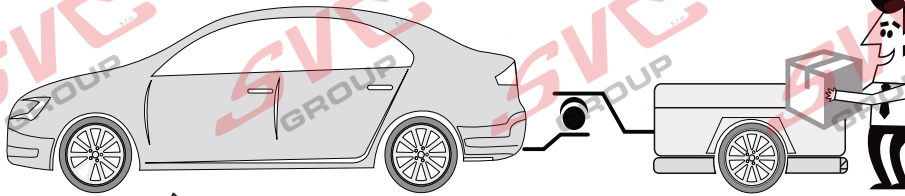

Vysokov 179
547 01 Náchod, Česká Republika

+420 603 360 607 +420 491421021



www.svcgroup.cz

Service Vitver Centrum

SVC GROUP ©-08-2019



CZ Pozor informace k záruce
SK Pozor informácie k záruke
EN Note the warranty information
DE Beachten Sie die Garantieinformationen

HU Vegye gyelembe a jótállási információkat
FR Notez les informations de garantie
IT Nota le informazioni sulla garanzia
NL Let op de garantie-informatie

ES Atención
FIN Huomio
PL Uwaga
RU Внимание

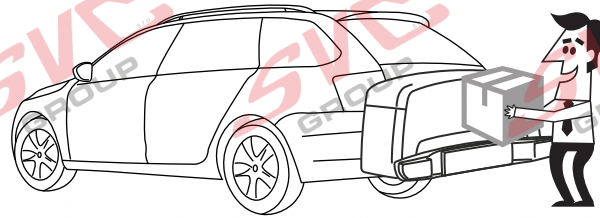
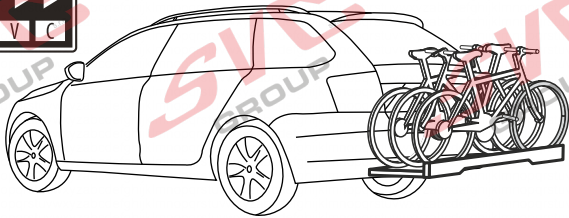

VTZ 001-531
VTZ 003-531

VTZ 002-531



3
max.

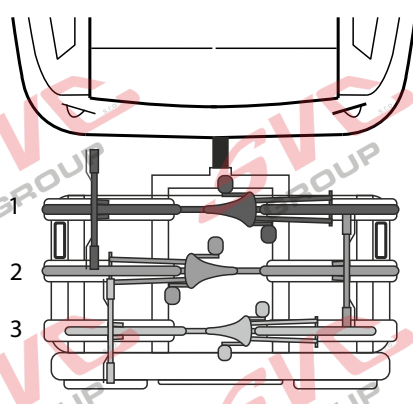

max. manual

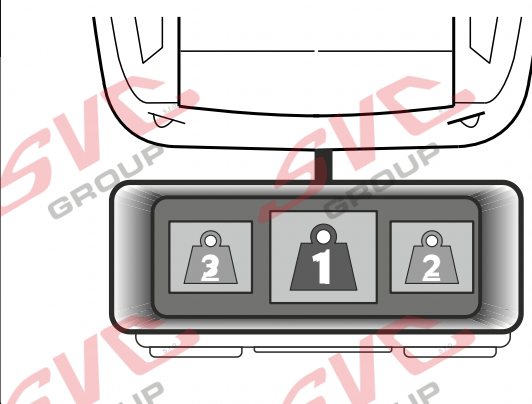
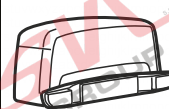
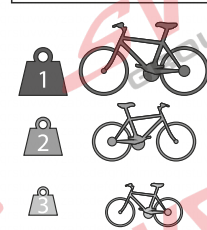

MAX.
5 km/h

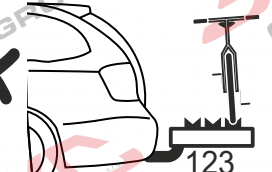
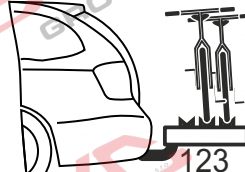
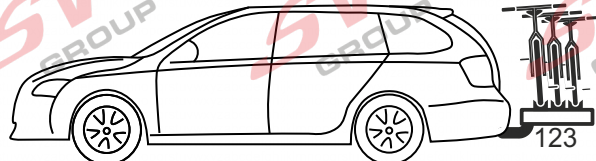
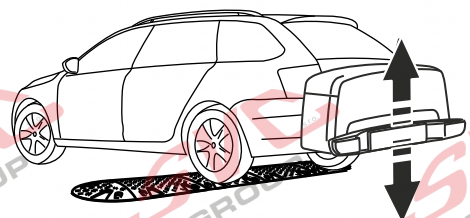
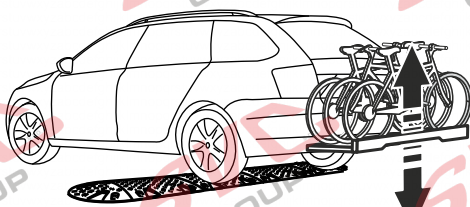

Vysokov 179
 547 01 Náchod, Česká Republika

+420 603 360 607 +420 491421021



www.svcgroup.cz