

POWER EXTENSION FOR +15

Partnr.: SP-135-ZZ

Engine off

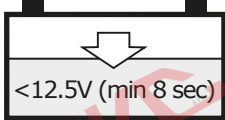

Engine running

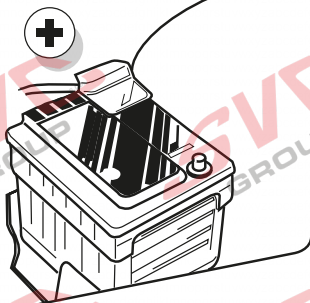
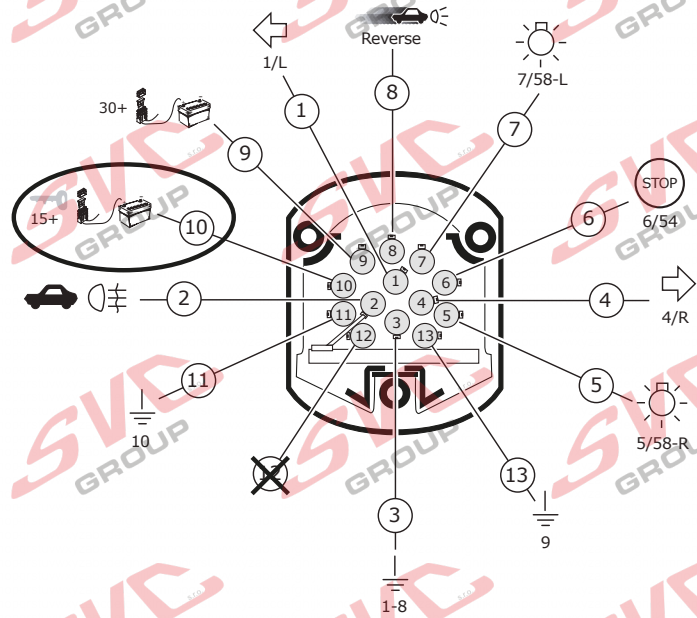
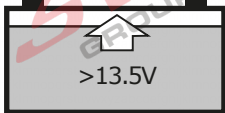

PIN 10

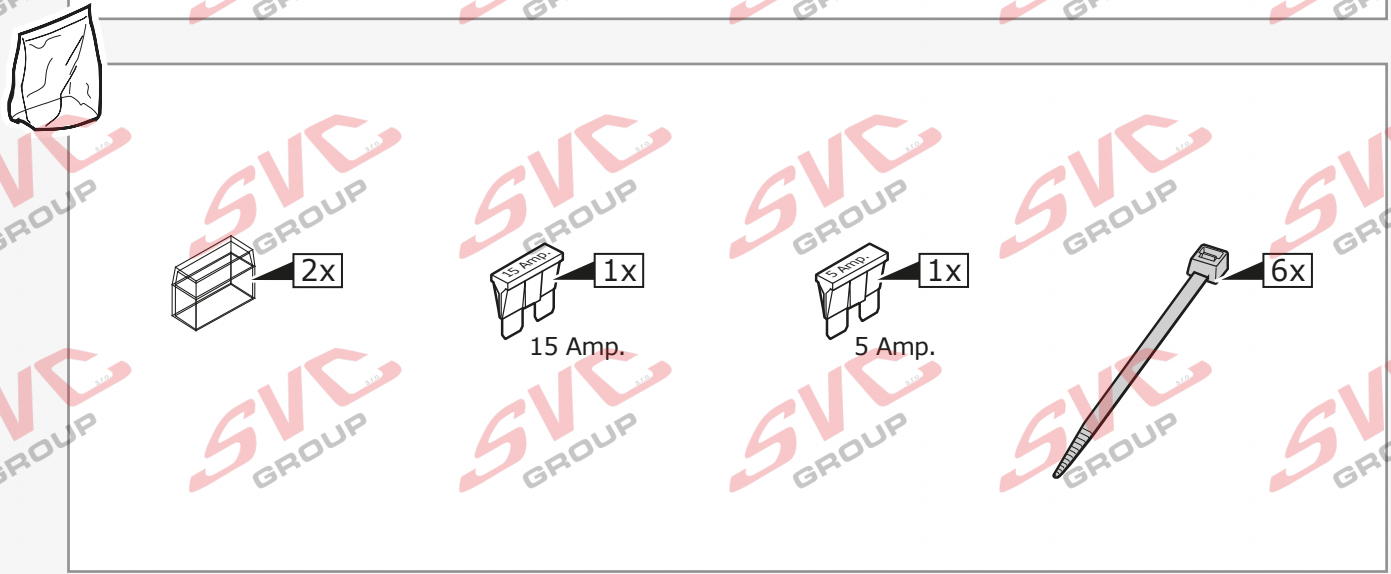
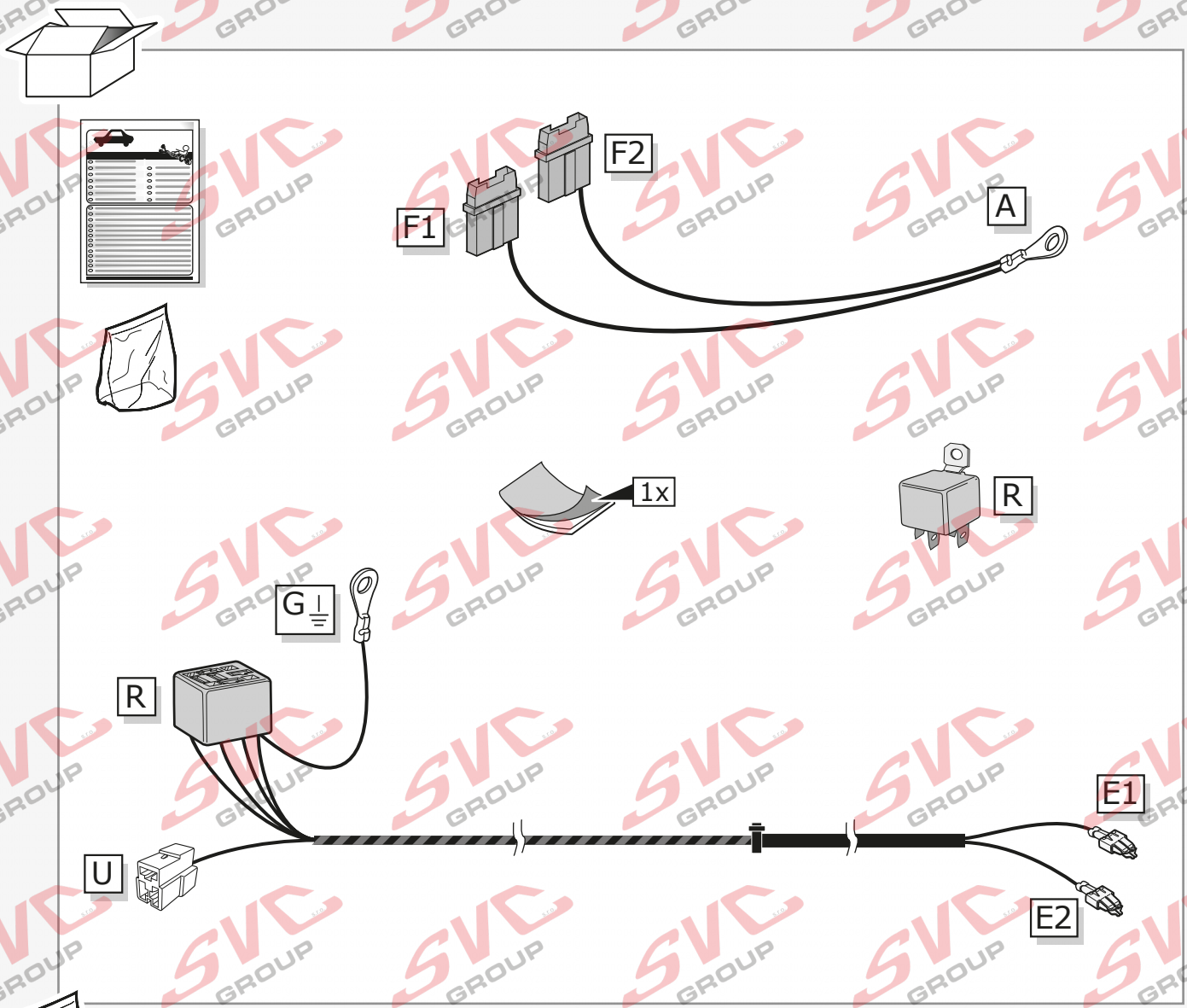

ROUTING

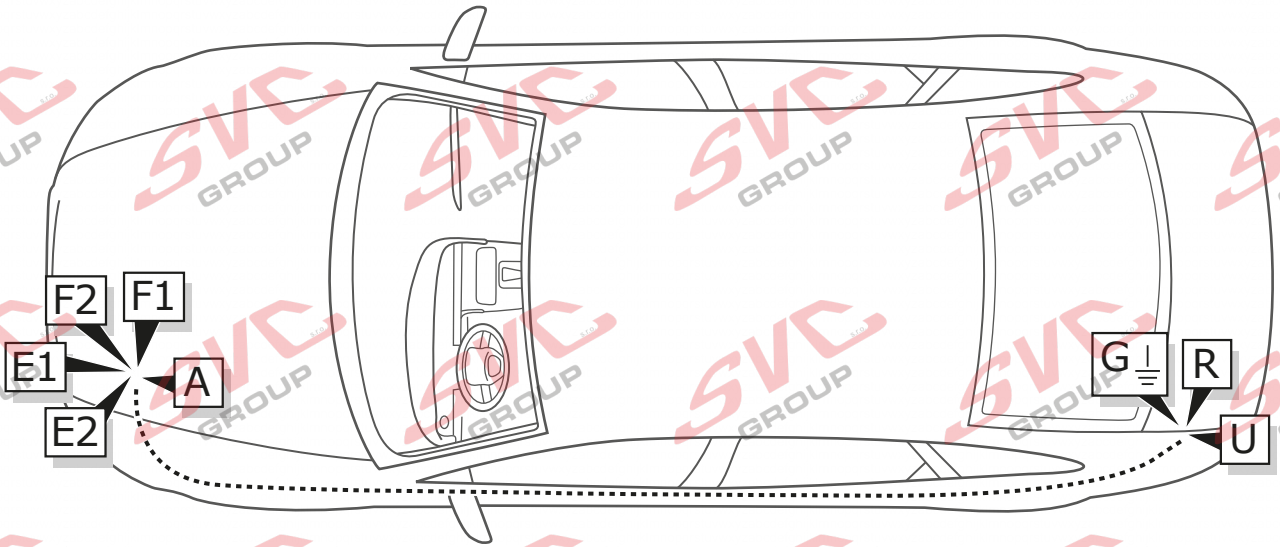

1

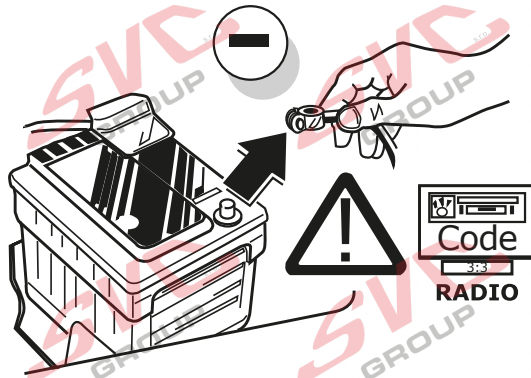

2

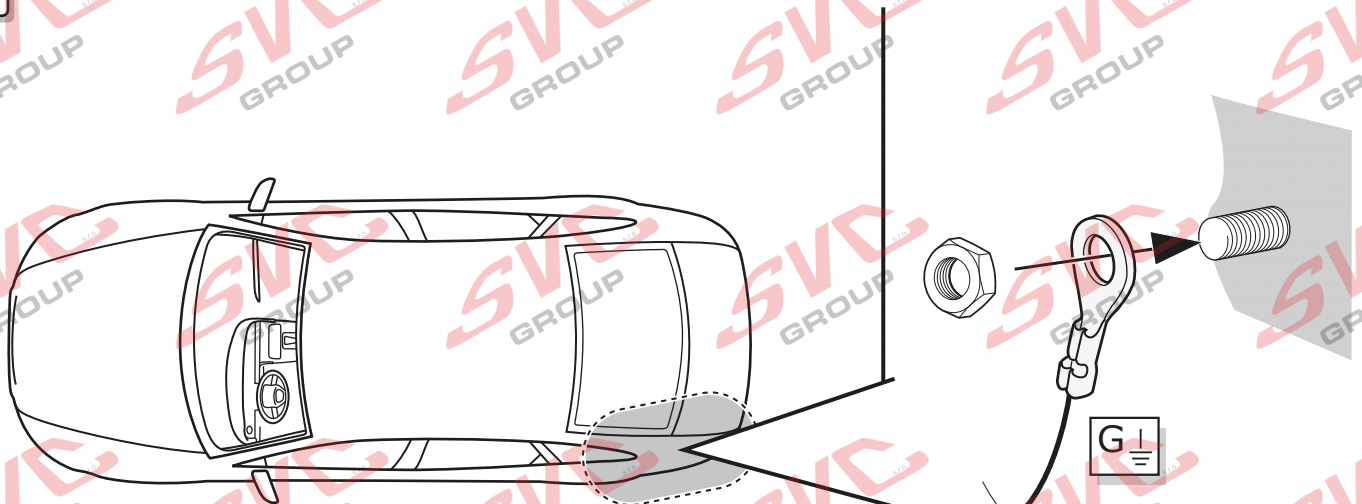

3



Info



- DE Elektrosätze
- FR Faisceaux d'Attelage
- NL Trekhaakkabelsets
- GB Tow bar wiring kit
- ES Kit eléctrico de enganche
- IT Set di cavi per gancio da traino
- SE Kabelsats dragkrok
- CZ Souprava pro elektrické připojení tažné tyče
- DK Ledningsføringsæt til trækstang
- FI Vetokoukun johtosarja
- GR Σετ καλωδίων μπάρας ρυμούλκησης
- NO Trekkrok kabelsett
- PL Zestaw okablowania dyszla holowniczego

U

- DE Elektrosätze
- FR Faisceaux d'Attelage
- NL Trekhaakkabelsets
- GB Tow bar wiring kit
- ES Kit eléctrico de enganche
- IT Set di cavi per gancio da traino
- SE Kabelsats dragkrok
- CZ Souprava pro elektrické připojení tažné tyče
- DK Ledningsføringsæt til trækstang
- FI Vetokoukun johtosarja
- GR Σετ καλωδίων μπάρας ρυμούλκησης
- NO Trekkrok kabelsett
- PL Zestaw okablowania dyszla holowniczego

4

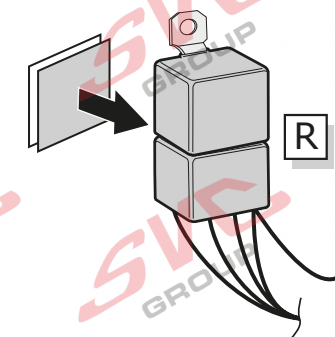
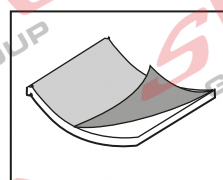
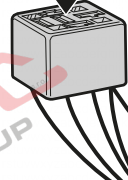
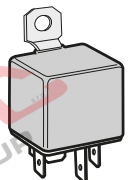

3

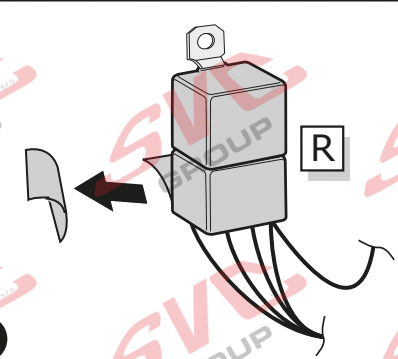

4

5

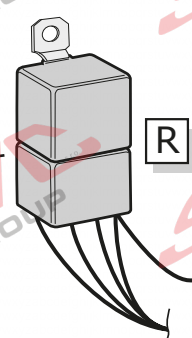
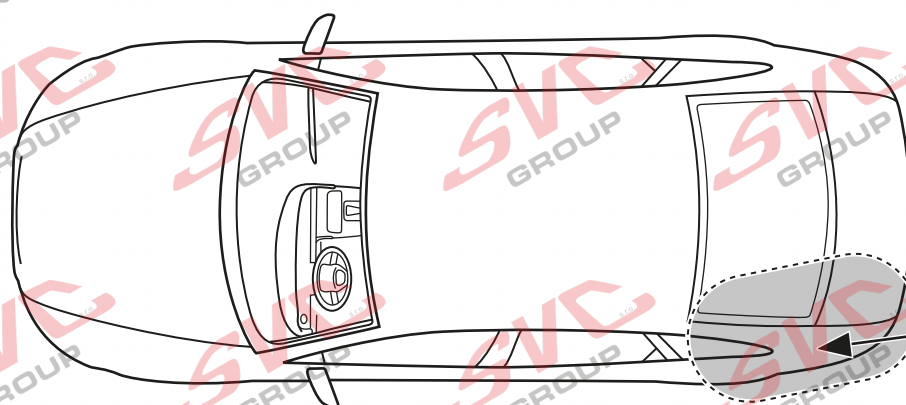

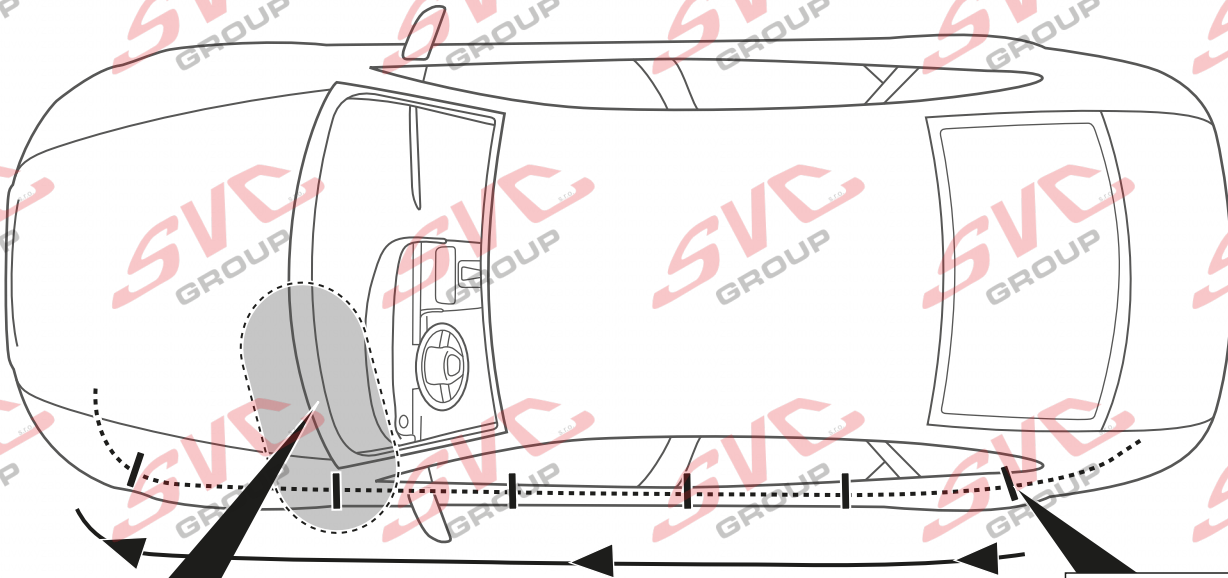

Option 1

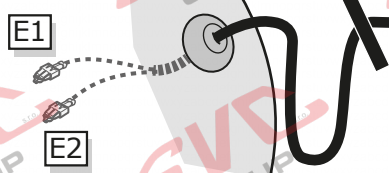
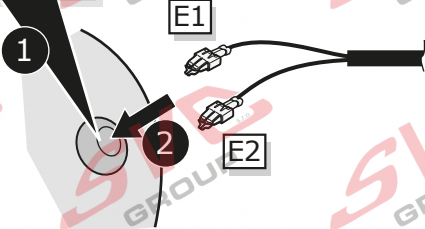
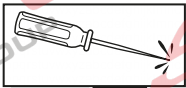

Option 2

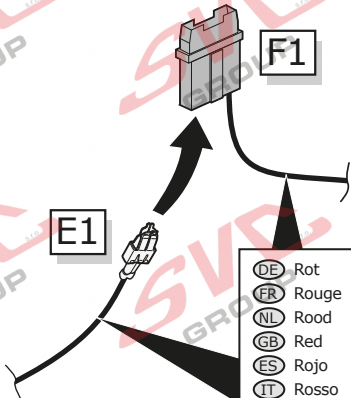
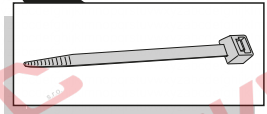
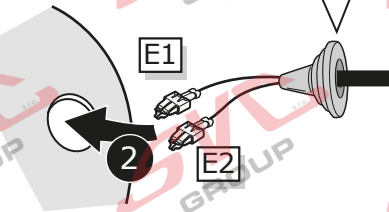
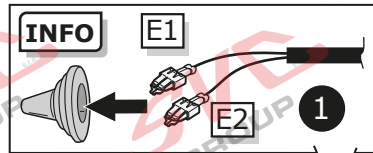
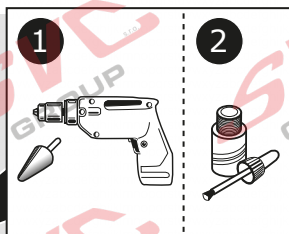

DE Rot	CZ Červená
FR Rouge	DK Rød
NL Rood	FI Punainen
GB Red	GR Κόκκινο
ES Rojo	NO Rød
IT Rosso	PL Czerwony
SE Röd	

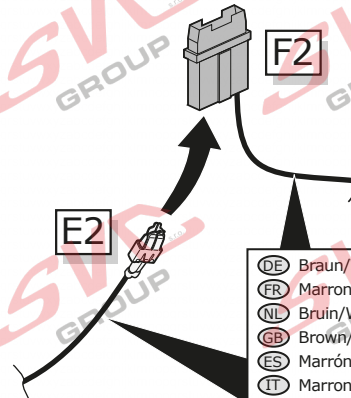

DE Braun/Weiß	CZ Hnědo/Bílá
FR Marron/Blanc	DK Brun/Hvid
NL Bruin/Wit	FI Ruskea/Valkoinen
GB Brown/White	GR Καφέ/Λευκό
ES Marrón/Blanco	NO Brun/Hvit
IT Marrone/Bianco	PL Brązowy/Biały
SE Brun/Vit	

8

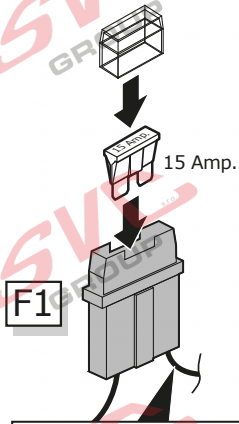

(DE) Rot	(CZ) Červená
(FR) Rouge	(DK) Rød
(NL) Rood	(FI) Punainen
(GB) Red	(GR) Κόκκινο
(ES) Rojo	(NO) Rød
(IT) Rosso	(PL) Czerwony
(SE) Röd	

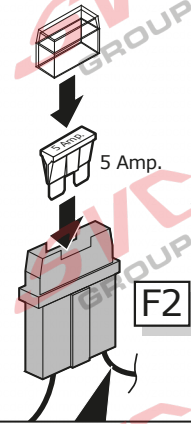

(DE) Braun/Weiß	(CZ) Hnědo/Bílá
(FR) Marron/Blanc	(DK) Brun/Hvid
(NL) Bruin/Wit	(FI) Ruskea/Valkoinen
(GB) Brown/White	(GR) Καφέ/Λευκό
(ES) Marrón/Blanco	(NO) Brun/Hvit
(IT) Marrone/Bianco	(PL) Brązowy/Biały
(SE) Brun/Vit	

9

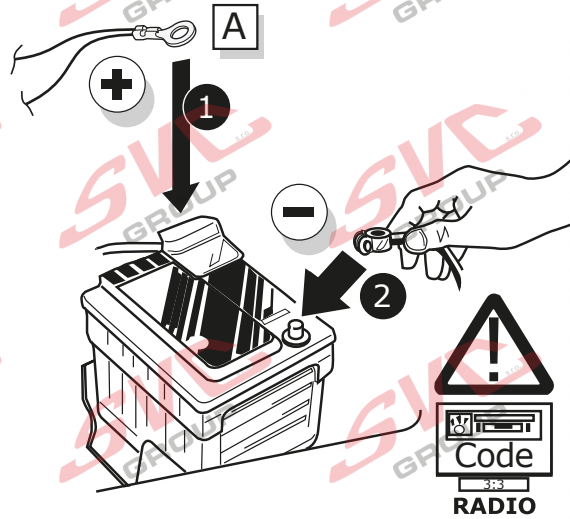

INFO

Products & Service: <https://www.ecs-electronics.nl/test-equipment>

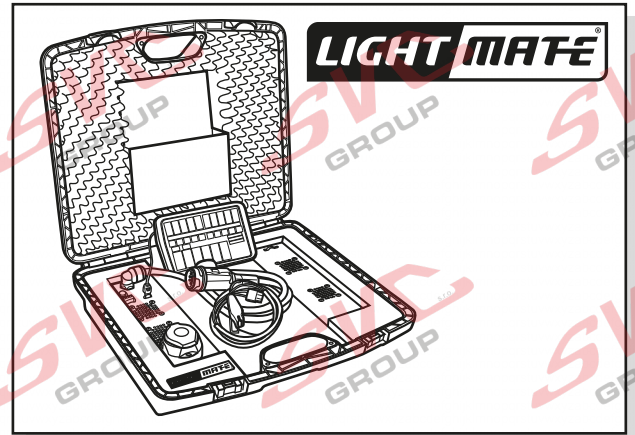
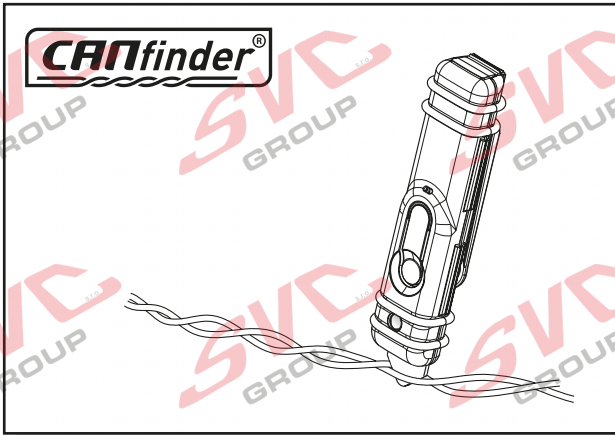

INFO



**FITTERS
TECHNICAL
SUPPORT**

**CALL
FREE
00800
2255
2327**



**MONDAY TO FRIDAY
08.00 - 12.00
13.00 - 17.00**

ts@ecs-electronics.nl
www.ecs-electronics.nl
tel: +31 (0)76 573 0020