

# Montážní návod

(Montážny návod, Fitting instruction, Montageanleitung,  
Istruzioni di montaggio, Monteringshandledning,  
Asennusohje, Instruction de montage,  
Montegehandleiding, Инструкция по установке)



## Tažné zařízení

Ťažné zariadenie  
Towbars  
Trekhaak  
Anhängerkupplung de  
Dispositif d'attelage  
Equipo de remolque  
Sprzęt holowniczy  
Hinauslaitteet  
Буксирное оборудование



výrobce / dodavatel  
**SVC Group s.r.o.**

**Odkaz na produkt:**

<https://www.svcgroup.cz/tazne-zarizeni-sro-uby-pevny-skoda-rapid-monte-carlo-10-20-12-2018-p7283-v960>



[www.svcgroup.cz](http://www.svcgroup.cz)

CZ - Tažné zařízení / SK - Ťažné zariadenie / GB - Towbars / PL - Haki holownicze  
DE - Anhängervorrichtungen / FR - Attelages / SPA - Ganchos / HUN – Vonohorgok  
RUS/FIN/LIT - Фаркопы / RO - Cârlig de remorcare

TYP VTZ 001-512 VTZ 002-512 VTZ 003-512

www.svcgroup.cz



**SVC GROUP s.r.o.**  
Průmyslová zóna 179  
547 01 Náchod  
Česká republika



Peugeot 2008/2008-e  
Opel Mokka / e-Mokka



01/2020 ->

03/2021 ->



1->2,0 h



2->2,5 h



Výřez není vidět

Výřez v vodorovné části pod vozem

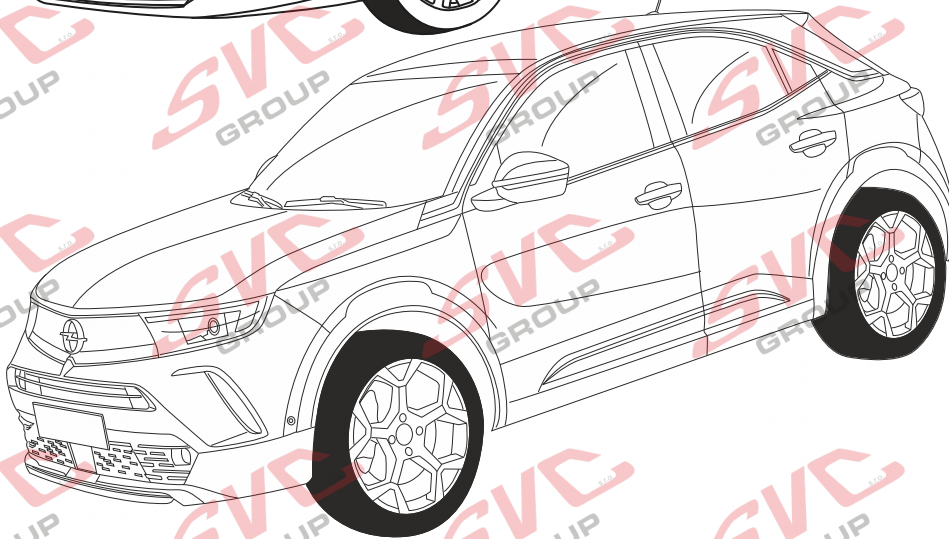
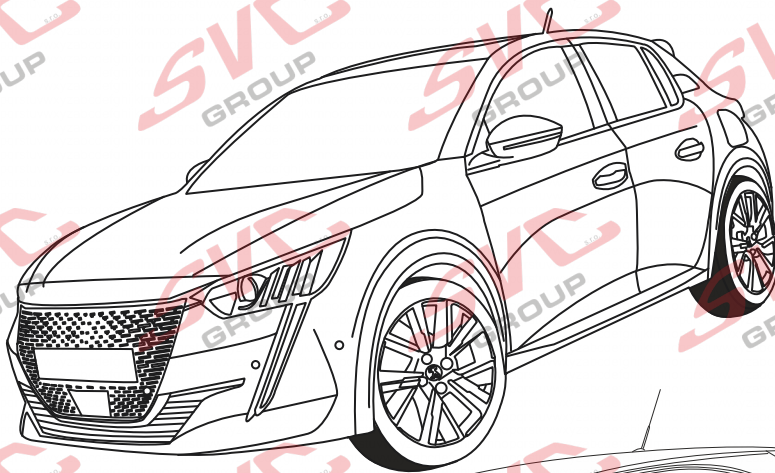
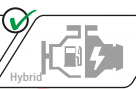

### Opel Mokka

Katalogová čísla pro příbal je  
součástí dodávky  
Catalog numbers for the package

1.001-512

1.002-512

1.003-512

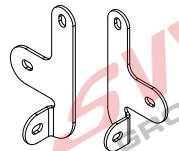

SCAN ME



CZ Pro podrobné montážní instrukce a podmínky výroby si naskenujte QR kód  
SK Pre podrobné montážne pokyny a podmienky produktu si môžete skenovať QR kód  
GB For detailed installation instructions and product conditions, scan the QR code  
DE Scannen Sie den QR-Code, um detaillierte Installationsanweisungen und Produktbedingungen zu erhalten  
FR Pour des instructions d'installation détaillées et les conditions du produit, scannez le code QR  
ITA Per istruzioni di installazione dettagliate e condizioni del prodotto, eseguire la scansione del codice QR  
PL Aby uzyskać szczegółowe instrukcje dotyczące instalacji i warunki produktu, zeskanuj kod QR  
SP Para obtener instrucciones detalladas de instalación y condiciones del producto, escanee el código QR  
NL Voor gedetailleerde installatie-instructies en productvoorwaarden, scan de QR-code  
FIN Tarkemmat asennusohjeet ja tuotteen ehdot on tarkistettava QR-koodilla  
HU A részletes telepítési utasítások és a termék feltételei között olvassa el a QR kódot  
SLO Za podrobna navodila za namestitve in pogoje izdelka skenirajte kodo QR  
RU Подробные инструкции по установке и условиям продукта отсканируйте QR-код.

SVC GROUP ©-11/19

e-mail: scv@scvgroup.cz Tel.: +420 491421021 +420 491421022 mob.: +420 603360607





Peugeot 2008/2008-e 01/2020->  
Opel Mokka / e-Mokka 03/2021->

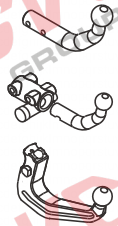

**VTZ 001-512**

**VTZ 002-512**

**VTZ 003-512**

**85**

**1400**

**7,53**

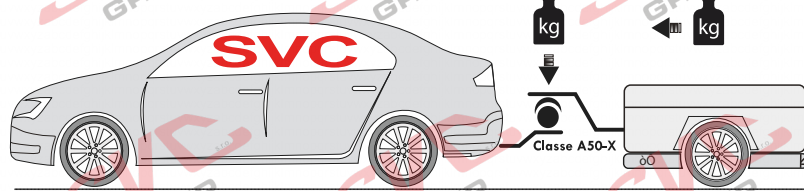

Katalogová čísla pro příbal  
Catalog numbers for the package  
1.001-512  
1.002-512  
1.003-512

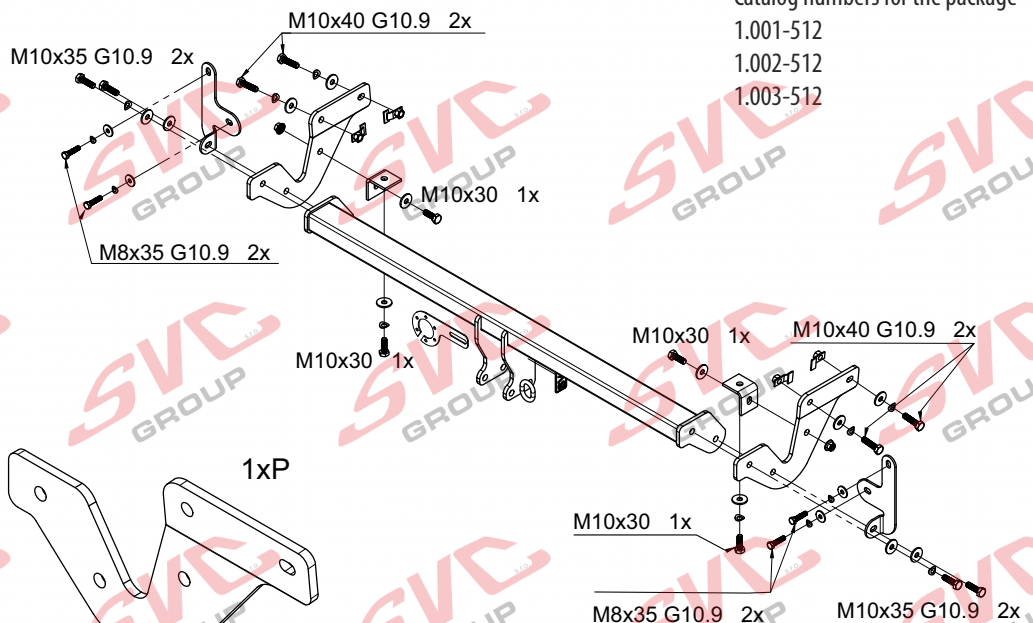

- M10x40 G10.9 4x
- M10x35 G10.9 4x
- M10x30 4x
- M8x35 G10.9 4x

- Ø10 8x
- Ø8 4x

- Ø10 12x
- Ø8 4x

- M10 4x

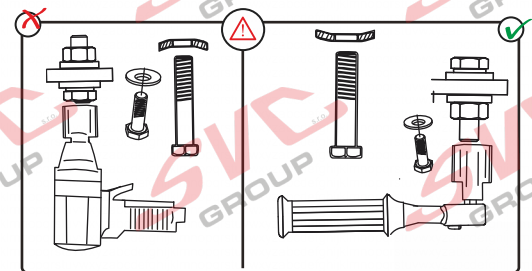
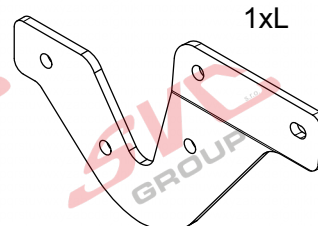
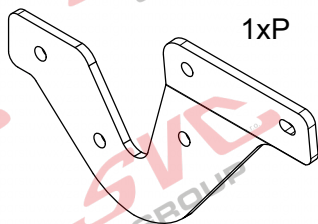
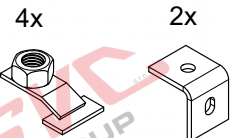

**55R-01-0553**

Pevnost	8,8	10,9	12,9
M6	9,7	14,3	16,1
M8	24,5	35,9	42,0
M10	48,4	71,0	83,0
M12	84,0	123,0	144,0
M14	133,0	196,0	229,0
M16	137,0	307,0	359,0

**55R-01-0553**

Approval Number Class <b>A50-X</b>	
Type	00-xxxx
D-Value	DL kN
Series	Vert.Id SL kg

- CZ Informace k provozu / homologaci
- SK Informácie na prevádzku / homologáciu
- EN Operating / homologation information
- DE Betriebs- / Zulassungsinformationen
- HU Üzemeltetési / homologációs információk
- FR Informations d'exploitation / homologatio
- IT Informazioni sull'operazione / omologazio
- NL Monteringsanvisningar
- ES Instrucciones de montaje
- FIN Montage-instructie
- SV Asennusohjeet
- NOR Drifts- / homologasjonsinformasjon
- PL Informacje dotyczące pracy / homologacji
- RU Информация о работе / омологации



SVC GROUP s.r.o. Průmyslová zóna - 179 547 01 Náchod-ČR

www.svcgroup.cz  
e-mail: svc@svcgroup.cz

Tel.: +420 491 421 021  
+420 491 421 022  
mob.: +420 603 360 607

QR kódem stáhnete rozšířeny montážní návod/ QR kódem stiahnete rozšírené montážny návod

SVC GROUP ©- 05/19



Peugeot 2008/2008-e 01/2020->  
Opel Mokka / e-Mokka 03/2021 ->



23/6000



1 400/85 D=7,53



55R-01-0553



1,5->2,0 h



2->2,5 h



**VTZ 001-512**

16,3



A-512-2021



**VTZ 002-512**

16,9



V-512-2021



**VTZ 003-512**

18,9



AV-512-2021

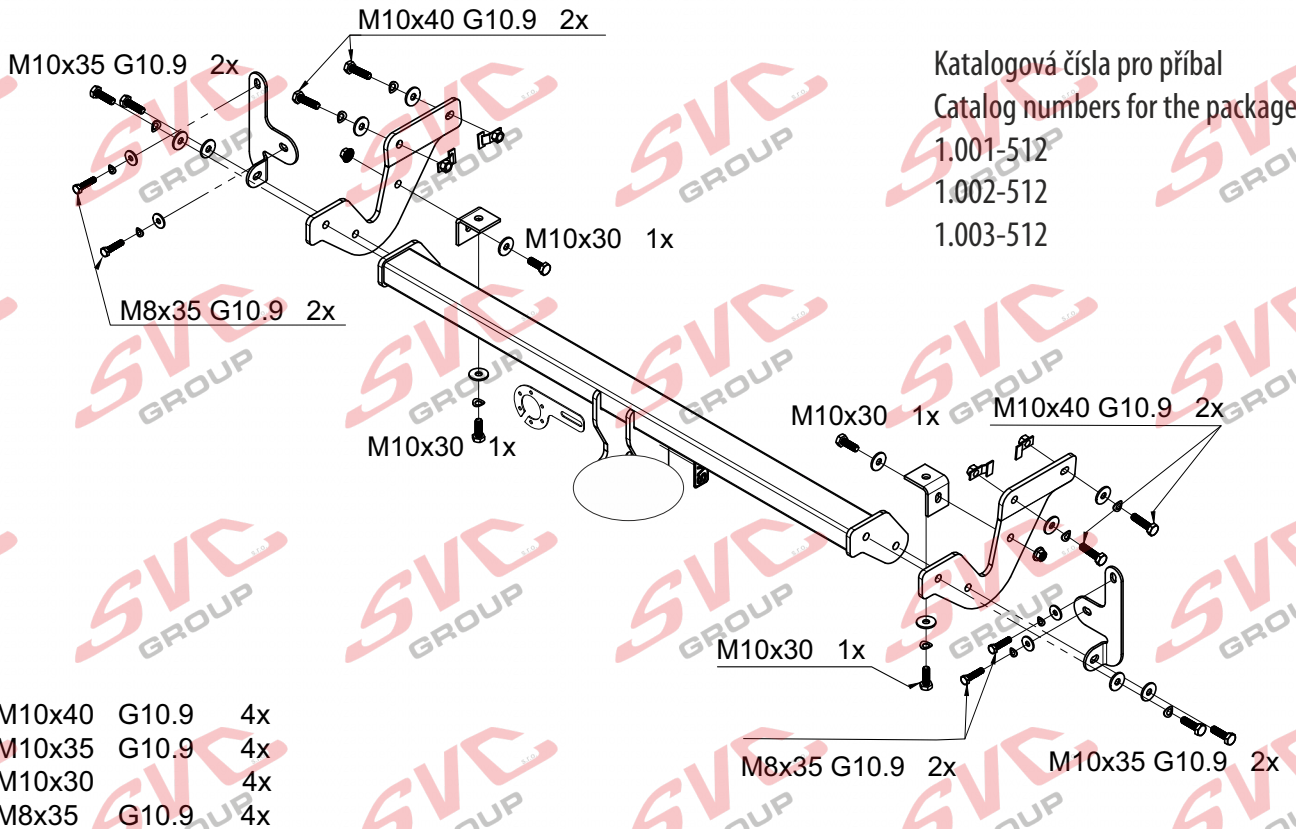

Katalogová čísla pro příbal  
Catalog numbers for the package

1.001-512

1.002-512

1.003-512

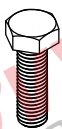

M10x40 G10.9 4x  
M10x35 G10.9 4x  
M10x30 4x  
M8x35 G10.9 4x



Ø10 8x  
Ø8 4x

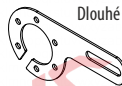

Dlouhé



Ø10 12x  
Ø8 4x



M10 4x

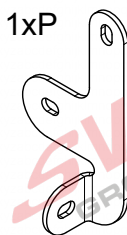

1xP

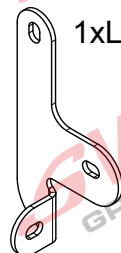

1xL

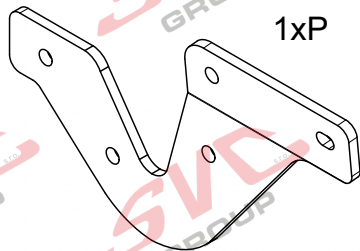

1xP

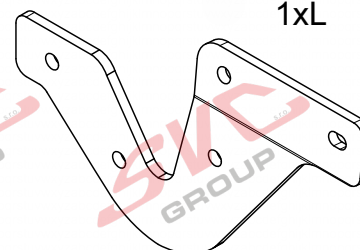

1xL

SVC GROUP



SVC GROUP s.r.o. Průmyslová zóna - 179 547 01 Náchod-ČR

www.svcgroup.cz  
e-mail: svc@svcgroup.cz

Tel.: +420 491 421 021  
+420 491 421 022  
mob.: +420 603 360 607

QR kódem si stáhnete si rozšířený montážní návod / With QR code you can download the extended assembly instructions

SVC GROUP ©- 05/19





Peugeot 2008/2008-e 01/2020->

Opel Mokka / e-Mokka 03/2021 ->

N-1

### CS Montážní návod Opel Mokka, Peugeot 2008

1. Odmontujte zadní světla, nárazník a uvolněte zadní část podběhů. Odmontujte zadní kola.
2. Odlepte záslepy na nosnících vozidla v místech úchytných bodů. Odšroubujte z výztuhy vozidla šrouby M8 z každé strany 2x dle obrázku.
3. Do nosníků vozidla nasuňte do úchytných bodů karosářské matky. Poté našroubujte levý a pravý bok tažného zařízení. (Nedotahujte) Od spodu nosníku přichyťte příložku tvaru L a tuto spojte s bokem tažného zařízení.
4. Do otvorů výztuhy namontujte přílohu 4 šrouby M8. (Nedotahujte) Poté namontujte hlavní nosník tažného zařízení. Celé tažné zařízení vyrovnejte a dotáhněte dle utahovacích momentů.
5. Namontujte zpět všechny díly odmontované v bodě č.1. Namontujte zpět zadní kola.

### SK Montážny návod Opel Mokka, Peugeot 2008 -

1. Odmontujte zadné svetlá, nárazník a uvoľnite zadnú časť podbehov. Odmontujte zadné kolesá.
2. Odlepte zaslepte na nosníkoch vozidla v miestach úchytných bodov. Odskrutkujte z výstuhu vozidla skrutky M8 z každej strany 2x podľa obrázku.
3. Do nosníkov vozidla nasuňte do úchytných bodov karosárske matky. Potom naskrutkujte ľavý a pravý bok ťažného zariadenia. (Nedotahujte) Od spodu nosníka prichyťte príložku tvare L a túto spojte s bokom ťažného zariadenia.
4. Do otvorov výstuhu namontujte prílohu 4 skrutkami M8. (Nedotahujte) Potom namontujte hlavný nosník ťažného zariadenia. Celé ťažné zariadenie vyrovnejte a dotiahnite podľa utahovacích momentov.
5. Namontujte späť všetky diely odmontované v bode č.1. Nainštalujte zadné kolesá.

### EN Installation instructions Opel Mokka, Peugeot 2008

1. Remove rear lights, bumper and release rear part of the wheel arches. Remove rear wheels.
2. Remove the stickers from vehicle beams at the fastening points. Remove two M8 screws from the vehicle stiffener on both sides as shown in the picture.
3. Insert J-nuts into vehicle beams and slide them into fastening points. Then screw on right and left sides of the tow bar. (Tighten only lightly). Attach L-shaped bracket from below the beam and connect it with the side of the tow bar.
4. Fix fitting plates into stiffener openings by four M8 screws. (Tighten only lightly). Then install the main beam of the tow bar. Then, align all the parts of the tow bar and tighten them to prescribed torques.
5. Reinstall all the parts removed within the step 1. Reinstall the rear wheels.

### DE Montageanleitung Opel Mokka, Peugeot 2008

1. Die Hecklichter und Stoßstange ausbauen und den hinteren Teil der Radläufe lösen. Die Hinterräder demontieren.
2. Blindverschlüsse auf den Trägern des Fahrzeugs, auf der Stelle der Befestigungspunkte, abnehmen. Die Schrauben M8 aus der Strebe des Fahrzeugs demontieren, 2 auf jeder Seite gemäß der Abbildung.
3. In die Träger des Fahrzeugs, in die Befestigungspunkte, Karosseriemuttern einstecken. Dann die linke und rechte Seite der Zugeinrichtung anschrauben (nicht festziehen). Von der unteren Seite des Trägers eine L-Scheibe befestigen und diese mit der Seite der Zugeinrichtung verbinden.
4. In die Öffnungen der Strebe 4 Schrauben M8 montieren (nicht festziehen). Dann den Hauptträger der Zugeinrichtung montieren. Die gesamte Zugeinrichtung ausrichten und mit entsprechenden Drehmomenten festziehen.
5. Alle im Punkt Nr. 1 ausgebauten Teile wieder einbauen. Die Hinterräder wieder montieren.

### IT Istruzioni di montaggio per l'Opel Mokka, Peugeot 2008

1. Smontare i fanali posteriori e il paraurti e allentare la parte posteriore dei copriruota. Smontare le ruote posteriori.
2. Allontanare le chiusure cieche dai supporti del veicolo, nel luogo dei punti di fissaggio. Svitare i bulloni M8 dal rinforzo del veicolo, 2 su ogni lato, vedi figura.
3. Inserire i dadi per carrozzeria nei supporti del veicolo, nei punti di fissaggio. Quindi montare il fianco sinistro e destro del dispositivo di traino (non serrare a fondo). Dal disotto del supporto fissare una piastrina a L collegandola con il fianco del dispositivo di traino.
4. Montare i 4 bulloni M8 nei fori del rinforzo (non serrare a fondo). Quindi montare il supporto principale del dispositivo di traino. Allineare tutto il dispositivo di traino e serrare con le coppie di serraggio prescritte.
5. Rimontare tutti i componenti smontati nel punto 1. Rimontare le ruote posteriori.



SVC GROUP s.r.o.

Průmyslová zóna - 179

547 01 Náchod-ČR

www.svcgroup.cz

e-mail: svc@svcgroup.cz

Tel.: +420 491 421 021

+420 491 421 022

mob.: +420 603 360 607

SVC GROUP © - 05/19

QR kódem stáhnete rozšířeny montážní návod/ QR kódem stiahnete rozšírené montážny návod

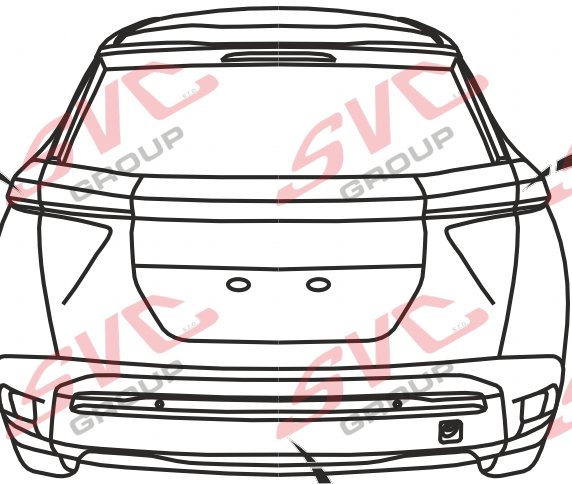

Montážní návod  
 Montážny návod  
 Installation instructions  
 Installationsanleitung  
 Instructions d'installation  
 Инструкция по установке

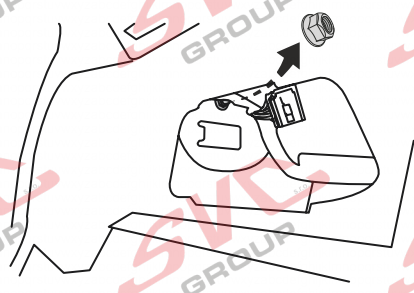
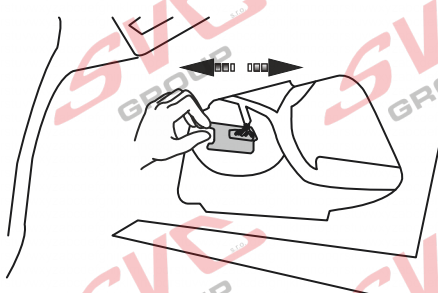
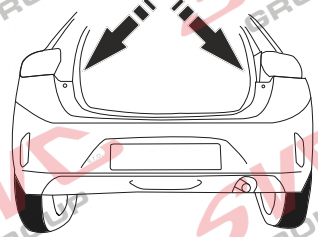
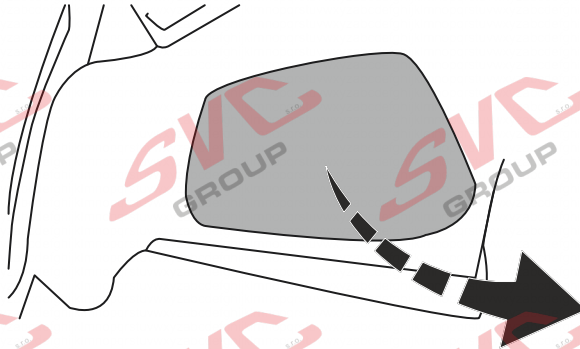
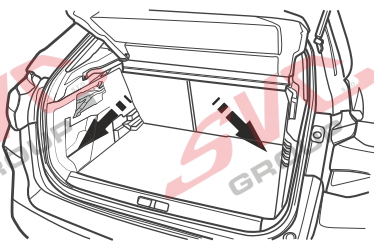



4.

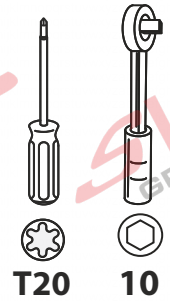
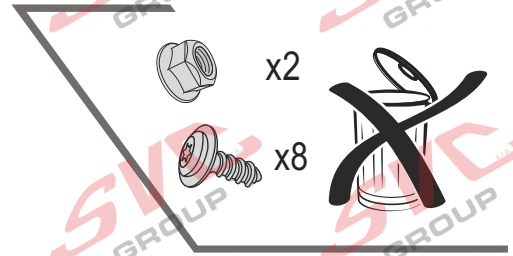
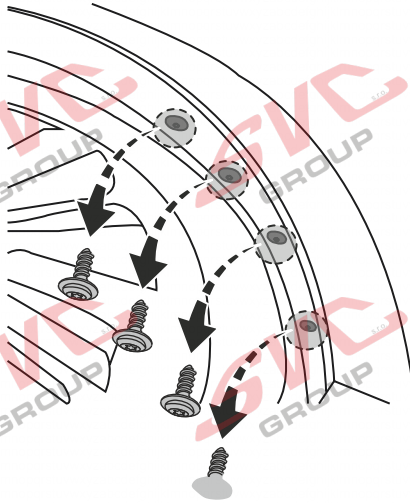
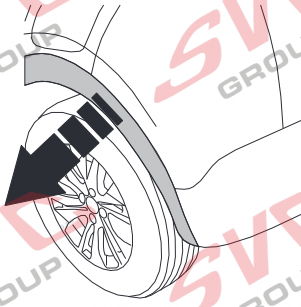

Dle přístupu a typu vozu

???

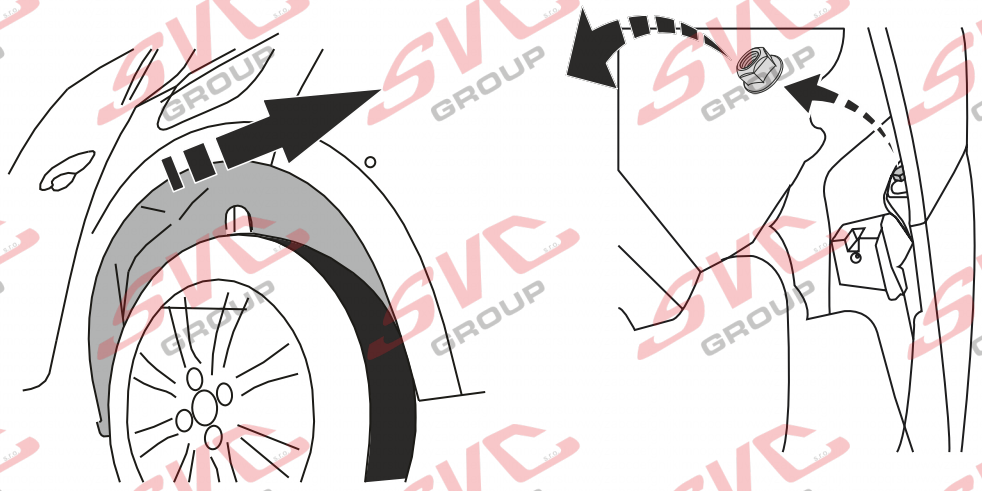
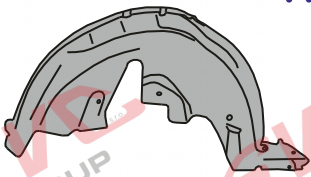

5.

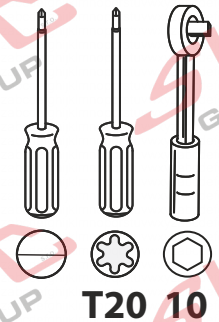
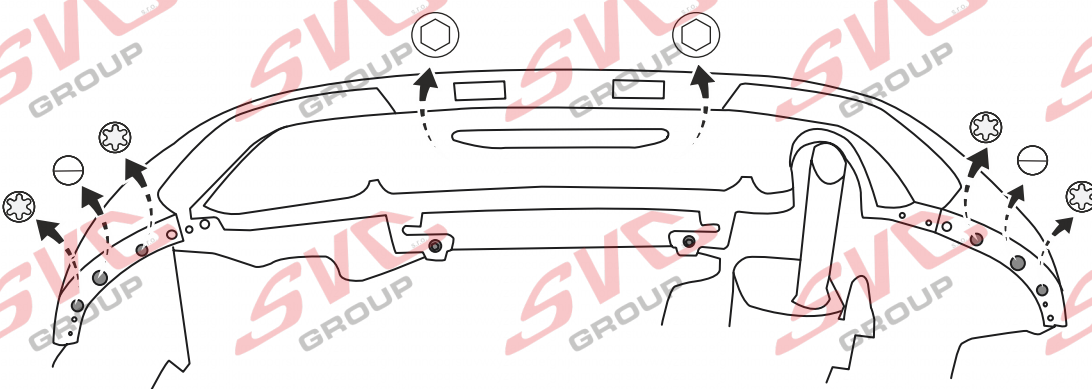

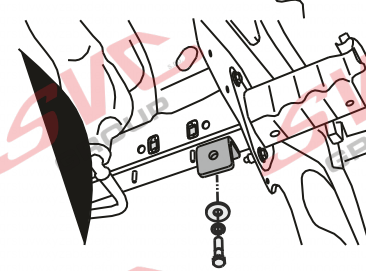
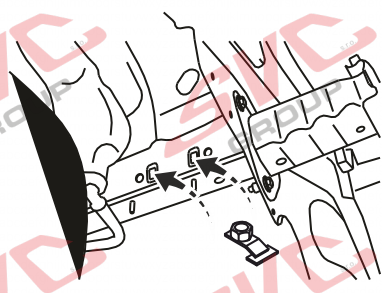
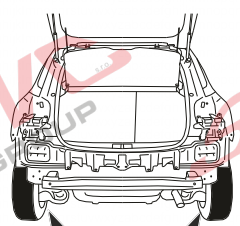
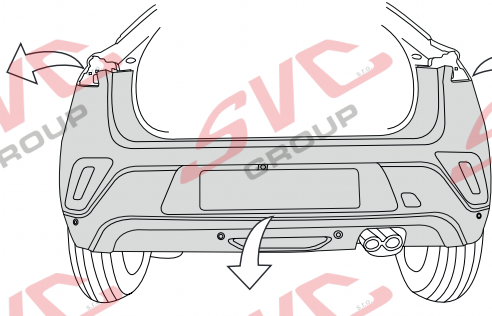

T20



x4

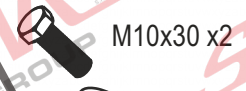

M10x30 x2



Ø10 x2

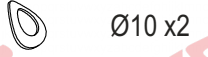

Ø10 x2

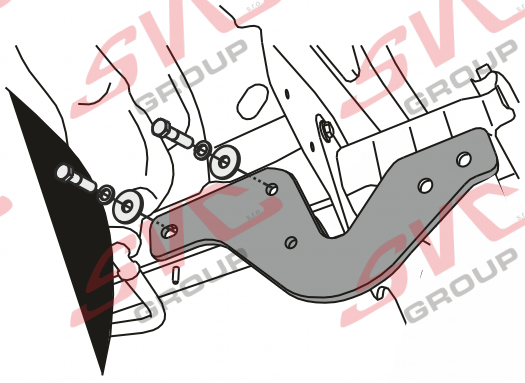
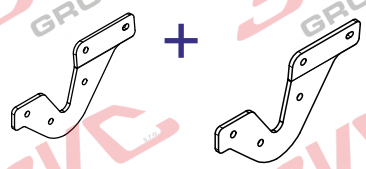

M10x40 x4



Ø10 x4

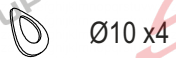

Ø10 x4



17

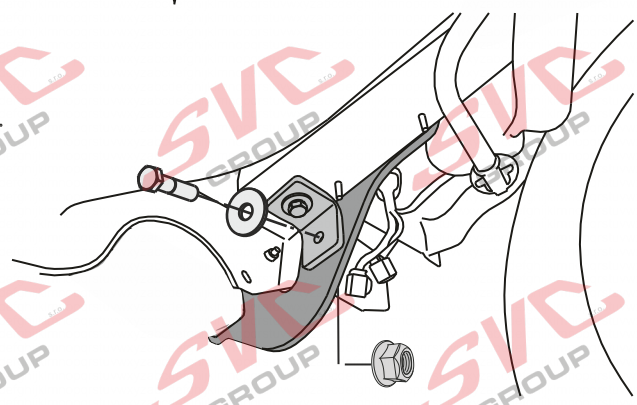

M10x20 x2



Ø10 x2



M10 x 2

SVC GROUP

SVC GROUP s.r.o. Průmyslová zóna - 179 547 01 Náchod-ČR www.svcgroup.cz e-mail: svc@svcgroup.cz

Tel.: +420 491 421 021 +420 491 421 022 mob.: +420 603 360 607

QR kódem stáhnete rozšířený montážní návod / Met QR-code kunt u de uitgebreide montage-instructies downloaden

SVC GROUP © - 05/19 05/19



8.

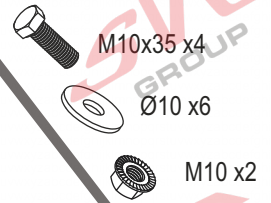
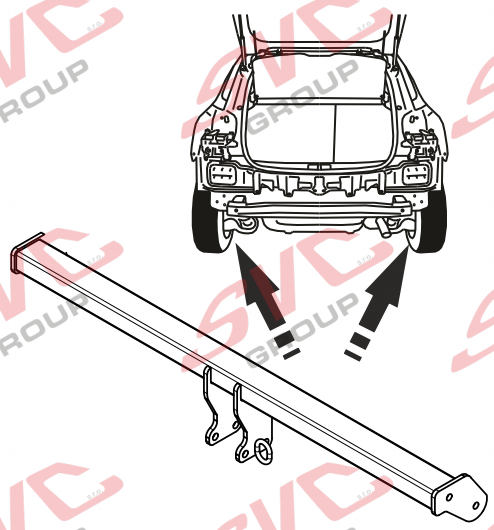
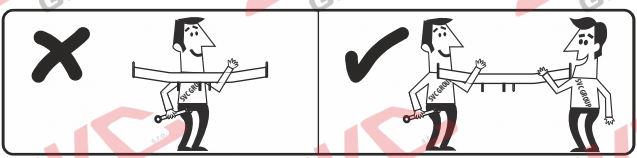

Jen pro vozidlo Opel Mokka / Only for Opel Mokka / Uniquement pour Opel Mokka / Nur für Opel Mokka

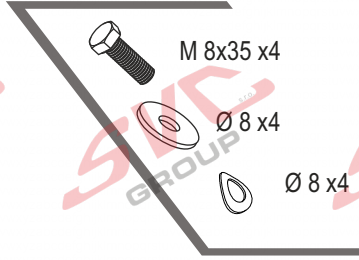
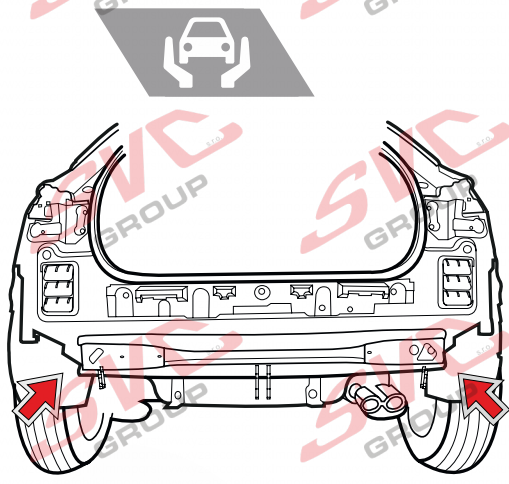
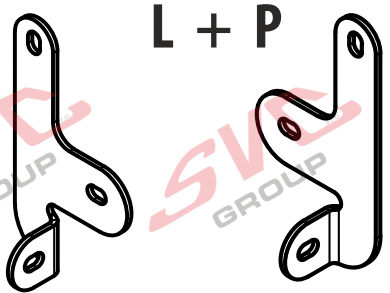

Katalogová čísla pro příbal  
Catalog numbers for the package

- 1.001-512
- 1.002-512
- 1.003-512

M8x35 G10.9 2x

M10x35 G10.9



9.

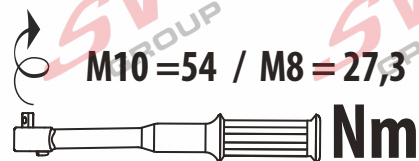
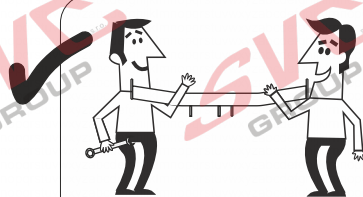
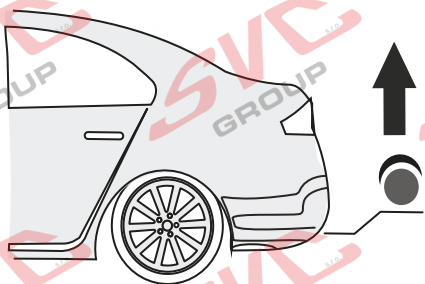

10.

Jen pro Peugeot II 2020 -> Only for Peugeot II 2020 -> Uniquement pour Peugeot II 2020 -> Nur für Peugeot II 2020 ->

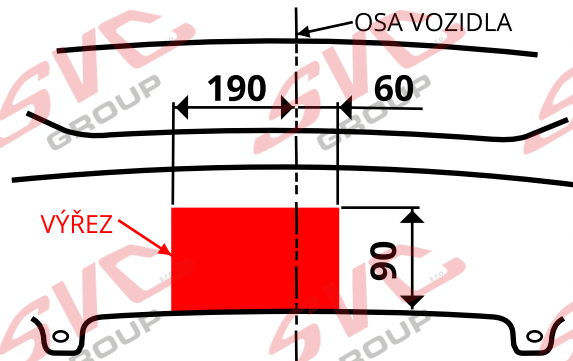
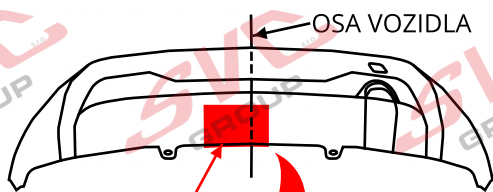

11.

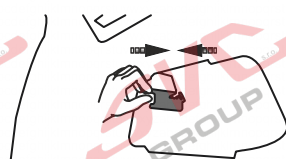
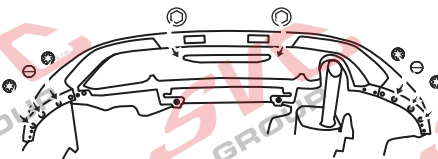
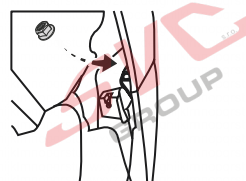
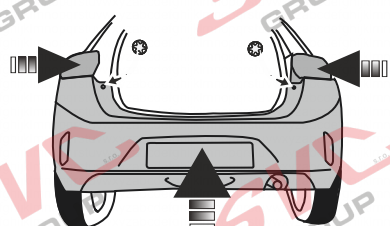



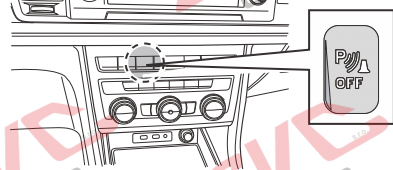
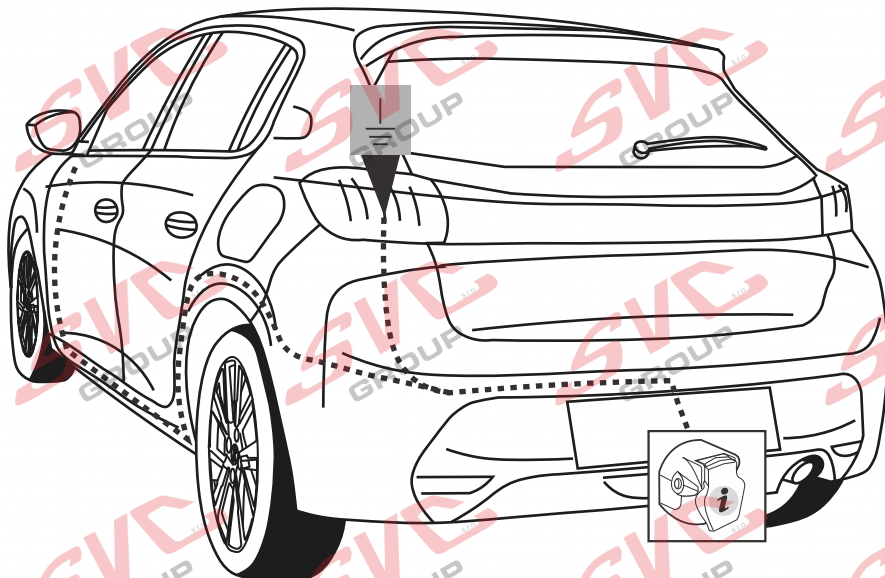

Informace pro odpojování couvacích senzorů PDC pro tažné zařízení

Vypínač pro vypínání couvacích senzorů PDC je umístěn na palubní desce vozu.

Nemusíte tedy pracně na elektro instalaci vozu napojovat odpojování couvacích senzorů PDC a zpětných kamer od elektro přípojky tažných zařízení.

Pokud chcete senzory vypnout, použijte vypínač na palubní desce.

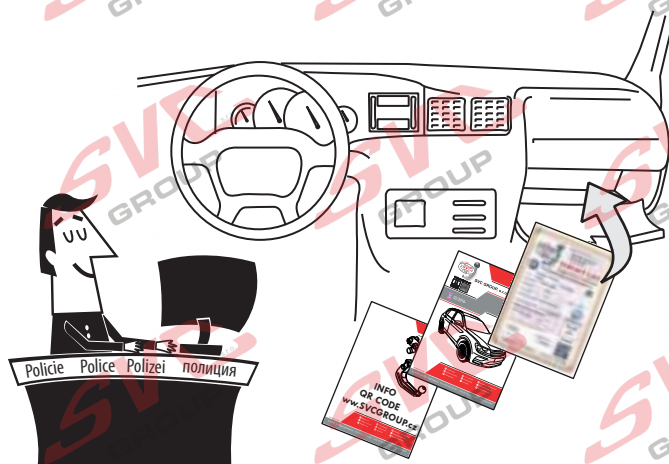
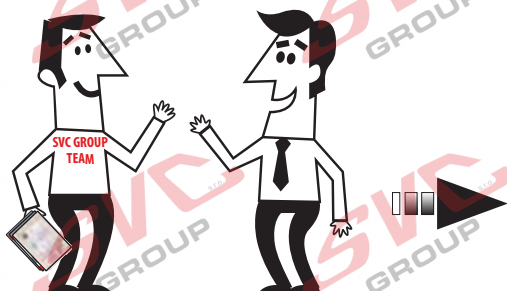

## SVC GROUP

Děkuje za důvěru / Ďakuje za důveru

Thank you for your trust / Danke Für dein Vertrauen

Merci pour votre conance / Grazie per la tua ducia

Tankewol foar jo fertrouwen / Спасибо за ваше доверие

Registrace / Registrácia

Registration / Registrierung

Inscription / Registrazione

Rekisteröinti / Регистрация



Nevíte si rady? Potřebujete poradit?

# Náš zákaznický servis je vám k dispozici

 +420 491 421 021

 [svc@svcgroup.cz](mailto:svc@svcgroup.cz)



Opravdový specialista a Certifikovaný výrobce tažných zařízení s největším sortimentem v ČR. Rodinná firma s více jak 30letou ověřenou tradicí výroby, prodeje a montáže.

[www.svcgroup.cz](http://www.svcgroup.cz)