

Montážní návod

(Montážny návod, Fitting instruction, Montageanleitung,
Istruzioni di montaggio, Monteringshandledning,
Asennusohje, Instruction de montage,
Montegehandleiding, Инструкция по установке)



Tažné zařízení

Ťažné zariadenie
Towbars
Trekhaak
Anhängerkupplung de
Dispositif d'attelage
Equipo de remolque
Sprzęt holowniczy
Hinauslaitteet
Буксирное оборудование



výrobce / dodavatel
SVC Group s.r.o.

Odkaz na produkt:

<https://www.svcgroup.cz/tazne-zarizeni-sro-uby-pevny-skoda-rapid-monte-carlo-10-20-12-2018-p7283-v960>



www.svcgroup.cz



CZ - Tažné zařízení / SK - Ťažné zariadenie / GB - Towbars / PL - Haki holownicze
 DE - Anhängervorrichtungen / FR - Attelages / SPA - Ganchos / HUN - Vonohorgok
 RUS/FIN/LIT - Фаркопы / RO - Cârlig de remorcare

TYP VTZ 001-504 VTZ 002-504 VTZ 003-504

www.svcgroup.cz



SVC GROUP s.r.o
 Průmyslová zóna 179
 547 01 Náchod
 Česká Republika



BMW X3 typ - F25

BMW X3 + GX3 typ - G01

BMW X4 typ - F26



2010 -> 2017

2017 ->

2010 -> 10/2018



1->2,0 h



2->2,5 h

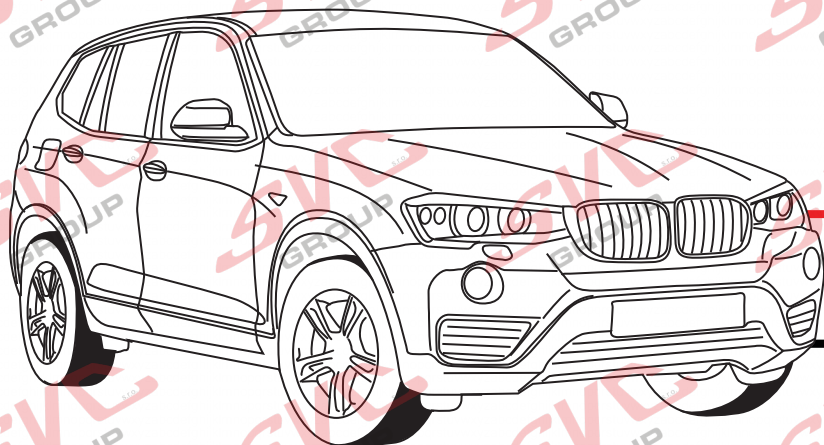

BMW x3

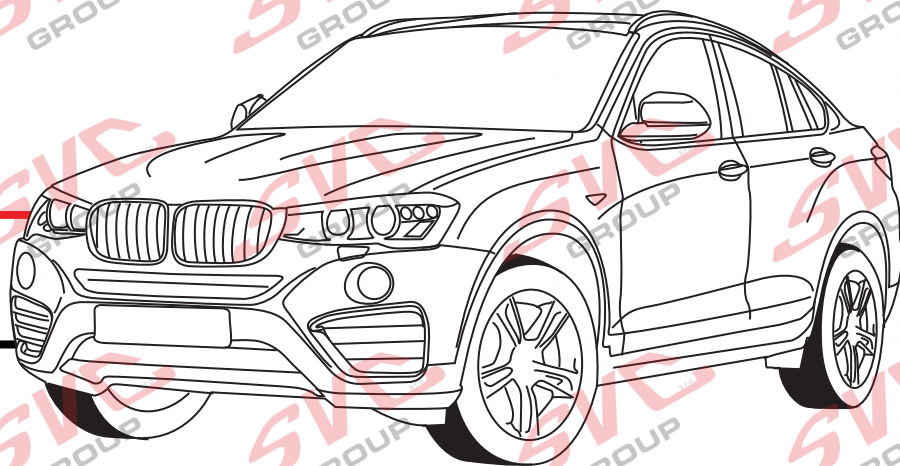

BMW x4



CZ Pro podrobné montážní instrukce a podmínky výrobku si naskenujte QR kód
 SK Pre podrobné montážne pokyny a podmienky produktu si môžete skenovať QR kód
 GB For detailed installation instructions and product conditions, scan the QR code
 DE Scannen Sie den QR-Code, um detaillierte Installationsanweisungen und Produktbedingungen zu erhalten
 FR Pour des instructions d'installation détaillées et les conditions du produit, scannez le code QR
 ITA Per istruzioni di installazione dettagliate e condizioni del prodotto, eseguire la scansione del codice QR
 PL Aby uzyskać szczegółowe instrukcje dotyczące instalacji i warunki produktu, zeskanuj kod QR
 SP Para obtener instrucciones detalladas de instalación y condiciones del producto, escanee el código QR
 NL Voor gedetailleerde installatie-instructies en productvoorwaarden, scan de QR-code
 FIN Tarkemmat asennusohjeet ja tuotteen ehdot on tarkistettava QR-koodilla
 HU A részletes telepítési utasítások és a termék feltételei között olvassa el a QR kódot
 SLO Za podrobna navodila za namestitve in pogoje izdelka skenirajte kodo QR
 RU Подробные инструкции по установке и условиям продукта отсканируйте QR-код.

SVC GROUP ©-11/19

e-mail: svc@scvgroup.cz Tel.: +420 491421021 +420 491421022 mob.: +420 603360607



BMW x3 F25
 BMW x3 G01
 BMW x4 F26



2010 -> 10/2017
 11/2017 ->
 2010 -> 10/2018



6007/11



2500/115 D 12,14



55R-01-0552



1,5->2,0 h



2->2,5 h



VTZ 001-504

15,40



A-504-2021



VTZ 002-504

15,80



A-504-2021



VTZ 003-504

18,40



AV-504-2021

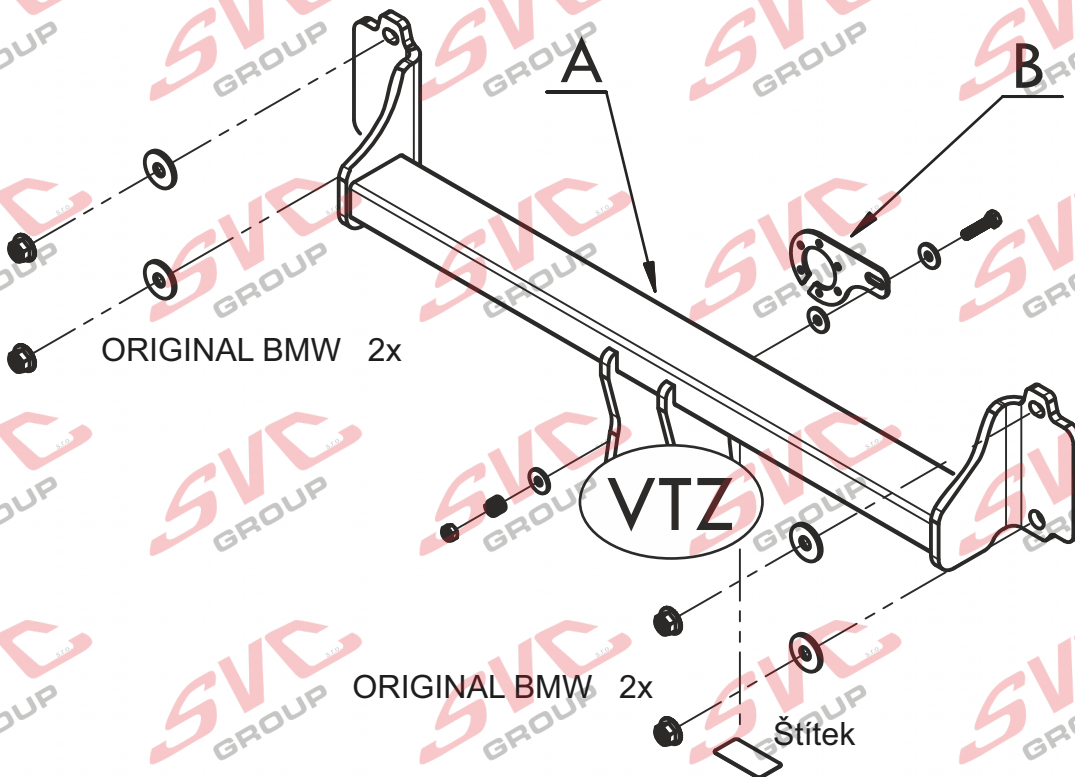

	A	x1			
Krátké	B	x1		Ø12	4ks





BMW x3 F25

BMW x3 G01

BMW x4 F26



2010 -> 10/2017

11/2017 ->

2010 -> 10/2018

115

2 500

D=

12,14

kN

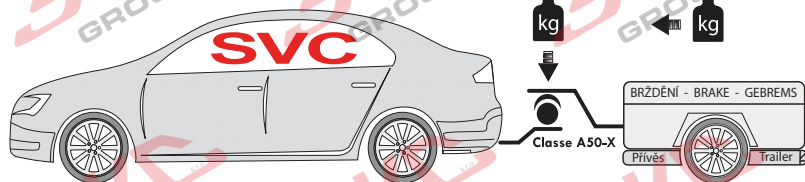

VTZ 001-504

VTZ 002-504

VTZ 003-504

ORIGINAL BMW 2x

VTZ

ORIGINAL BMW 2x

Štítek

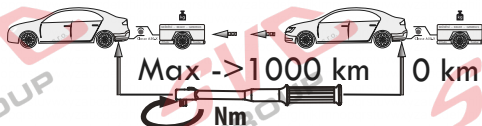
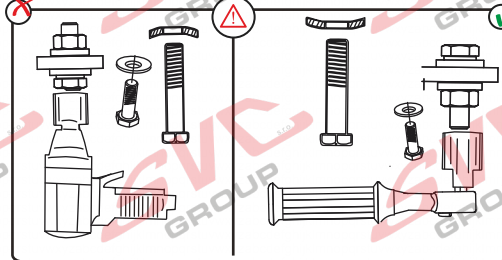

Pevnost	8,8	10,9	12,9
M6	9,7	14,3	16,1
M8	24,5	35,9	42,0
M10	48,4	71,0	83,0
M12	84,0	123,0	144,0
M14	133,0	196,0	229,0
M16	137,0	307,0	359,0



Nm



Homologace EHK 55-R 55R-01-0552



- | | |
|-----------------------------------------------------|----------------------------------------------------|
| CZ Informace k provozu / homologaci | NL Monteringsanvisningar |
| SK Informácie na prevádzku / homologáciu | ES Instrucciones de montaje |
| EN Operating / homologation information | FIN Montage-instructie |
| DE Betriebs- / Zulassungsinformationen | SV Asennusohjeet |
| HU Üzemeltetési / homologációs információk | NOR Drifts- / homologasjonsinformasjon |
| FR Informations d'exploitation / homologatio | PL Informacje dotyczące pracy / homologacji |
| IT Informazioni sull'operazione / omologazio | RU Информация о работе / омологации |



SVC GROUP s.r.o.

Průmyslová zóna - 179
547 01 Náchod-ČR

www.svcgroup.cz
e-mail: svc@svcgroup.cz

Tel.: +420 491 421 021
+420 491 421 022
mob.: +420 603 360 607
SVC GROUP ©



BMW x3 F25
BMW x3 G01
BMW x4 F26



2010 -> 10/2017
11/2017 ->
2010 -> 10/2018

N-1

CS Montážní návod

Pro podrobné montážní instrukce a podmínky výrobku si naskenujte QR kód

1. Odmontujte zadní světla, nárazník a jeho ocelovou výztuhu (tato již nebude zapotřebí).
2. Na místo po ocelové výztuze namontujte hlavní nosník tažného zařízení za pomoci stávajících matic M12 (BMW) přes velkoplošné podložky. Dotáhněte dle utahovacích momentů. Dbejte na vyrovnaní tažného zařízení.
3. Zhotovte výřez nárazníku dle typu vozidla. Namontujte zpět všechny díly odmontované v bodě č. 1.

EN Installation instructions

For detailed installation instructions and product conditions, scan the QR code

1. Remove rear lights, bumper and its steel stienner (it is no longer needed).
2. Attach the main beam of the tow bar instead of the steel stienner; use existing M12 nuts (BMW) and large-area washers. Tighten to prescribed torques. Mind the alignment of the tow bar.
3. Make a cut-out in the bumper according to the vehicle type. Reinstall all the parts removed within the step 1.

SK Montážny návod

Pre podrobné montážne pokyny a podmienky produktu si môžete skenovať QR kód

1. Demontirajte zadnje luči, odbijač in njegovo jekleno ojačitev (le-ta ne bo več potrebna).
2. Na mesto, kjer je bila jeklena ojačitev, namestite glavni nosilec vlečne kljuka s pomočjo obstoječih matic M12 (BMW) in širokih podložk. Zategnite glede na zatezne momente. Pazite, da bo vlečna kljuka poravnana.
3. Naredite izrez za odbijač glede na tip vozila. Vse dele, demontirane v točki št. 1, montirajte nazaj.

DE Montageanleitung

Scannen Sie den QR-Code, um detaillierte Installationsanweisungen und Produktbedingungen zu erhalten

1. Die Hecklichter, Stoßstange und deren Stahlverstrebung ausbauen (diese wird nicht mehr benötigt).
2. Anstelle der Stahlverstrebung den Hauptträger der Zugeinrichtung mittels der bestehenden Muttern M12 (BMW) und der großächigen Unterlegscheiben montieren. Mit den entsprechenden Anzugsmomenten festziehen. Auf Ausrichtung der Zugeinrichtung achten.
3. Einen Ausschnitt in der Stoßstange gemäß dem Fahrzeugtyp herstellen. Alle im Punkt Nr. 1 ausgebauten Teile wieder einbauen.

PL Instrukcja montażu

Aby uzyskać szczegółowe instrukcje instalacji i warunki produktu, zeskanuj kod QR

1. Demontujemy tylne lampy, zderzak i jego stalowe wzmocnienie (nie będzie już więcej potrzebne).
2. W miejscu stalowego wzmocnienia montujemy belkę główną urządzenia holowniczego za pomocą istniejących nakrętek M12 (BMW) przez podkładki wielkopowierzchniowe. Nakrętki dokręcamy z zachowaniem zalecanych momentów dokręcania. Pamiętajmy o wykonaniu końcowego, równego ustawienia urządzenia holowniczego.
3. Zgodnie z typem pojazdu wykonujemy wycięcie w zderzaku. Montujemy ponownie wszystkie części zdemontowane w punkcie nr 1."

FR Notice de montage

Pour des instructions d'installation détaillées et les conditions du produit, scannez le code QR

1. Déposer les feux arrières, le pare-chocs et son renfort en acier (ce dernier ne sera plus nécessaire).
2. À l'aide de vis M12 (BMW) existants, monter, sur des rondelles de grande surface, le longeron principal du dispositif d'attelage à la place du renfort en acier. Serrer aux couples préconisés. S'assurer que le dispositif d'attelage soit égalisé.
3. Faire une découpe dans le pare-chocs en fonction du type de véhicules. Reposer toutes les pièces déposées à la section n°1.

FI Asennusohje

Tarkemmat asennusohjeet ja tuotteen ehdot on tarkistettava QR-koodilla

1. Irrota takavalot, puskuri ja sen teräsjäykiste (sitä ei enää tarvita).
2. Asenna teräsjäykisteeseen paikalle vetolaitteen pääpalkki entisillä muttereilla M12 (BMW) suurilla aluslevyjä käyttäen. Kiristä kiristysmomenttien mukaisesti. Varmista, että vetolaitte tulee suoraan.
3. Tee puskuriin leikkaus auton tyyppin mukaan. Asenna takaisin kaikki kohdassa 1. irrotetut osat.



QR k

SVC GROUP s.r.o.

Průmyslová zóna - 179
547 01 Náchod-ČR

www.svcgroup.cz

e-mail: svc@svcgroup.cz

tructions

Tel.: +420 491 421 021
+420 491 421 022
mob.: +420 603 360 607

SVC GROUP ©- 05/19

1.

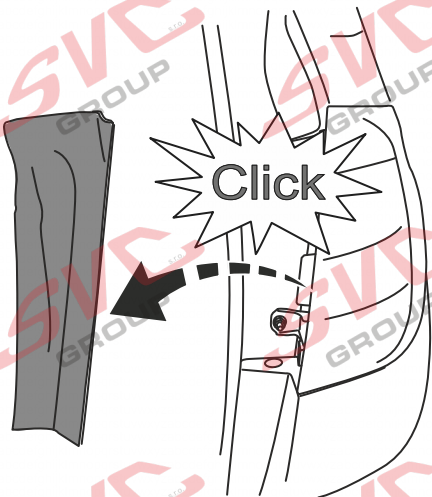
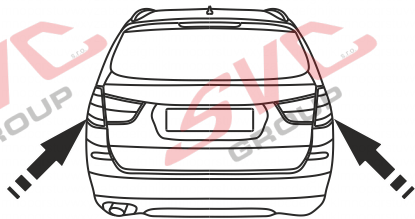

Montážní návod
Montážny návod
Installation instructions
Installationsanleitung
Instructions d'installation
Инструкция по установке

2.

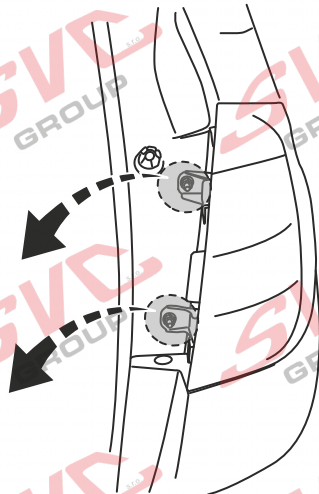
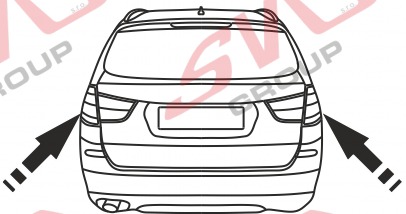

10



3.

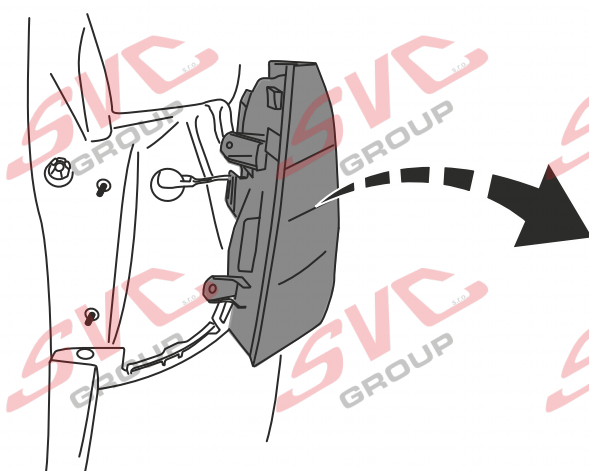
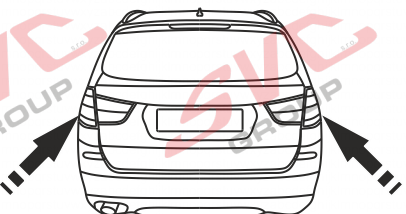

4.

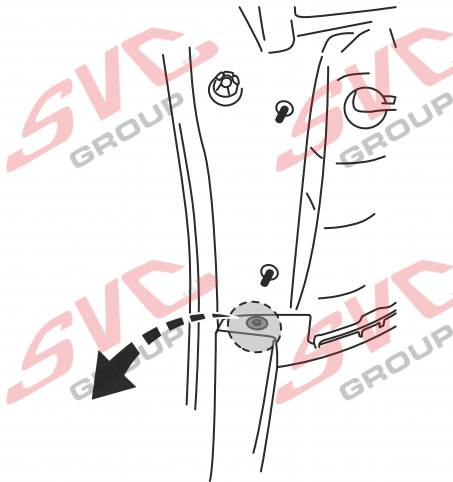

5.

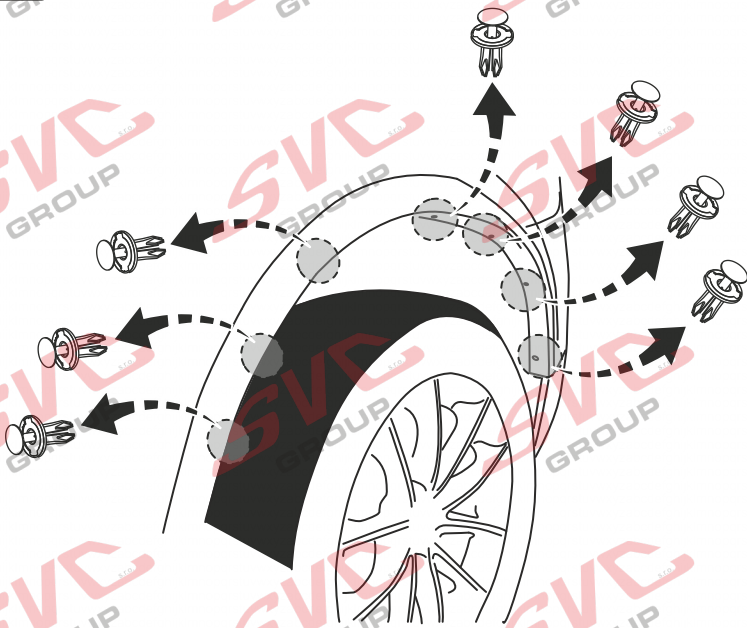
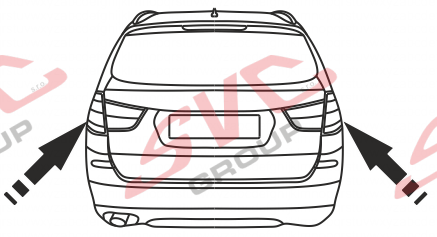

6.

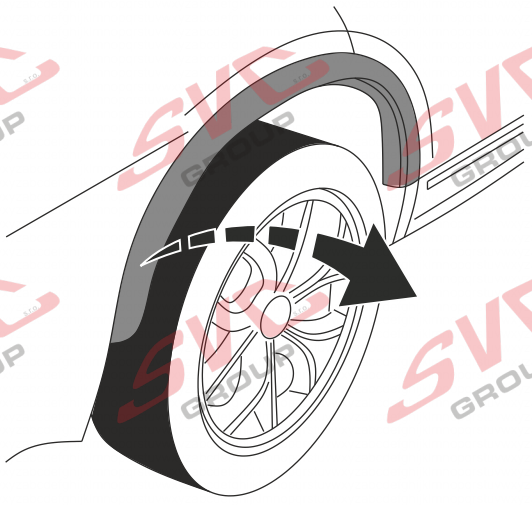
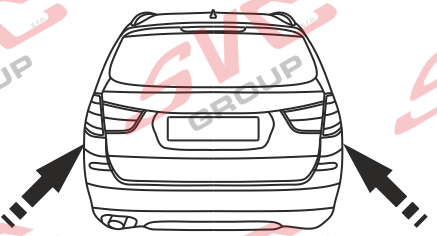

7.

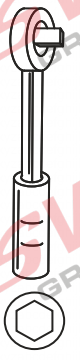
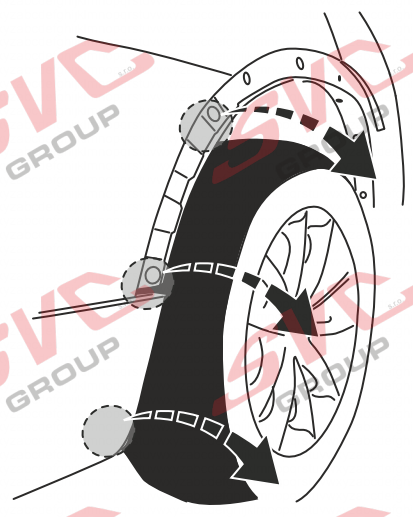
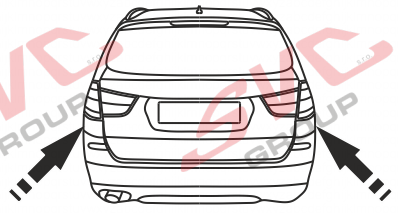

8

8.

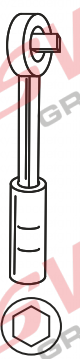
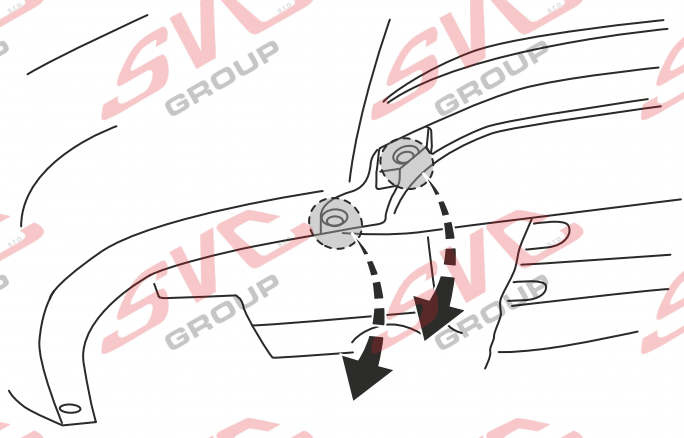
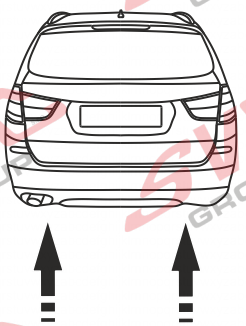

8

9.

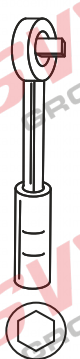
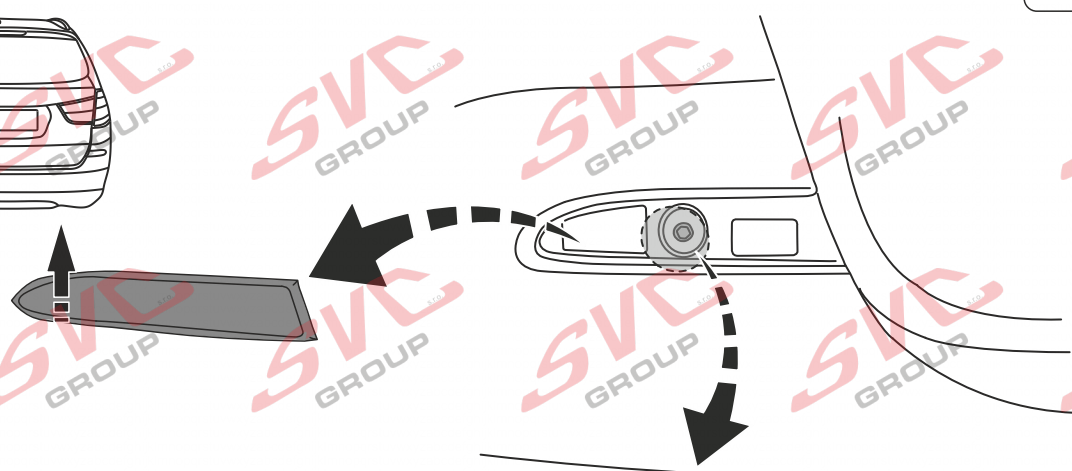
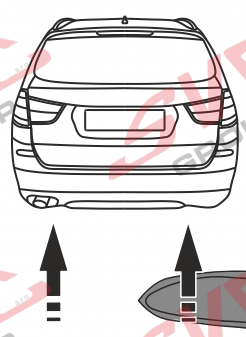

8

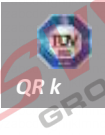

10.

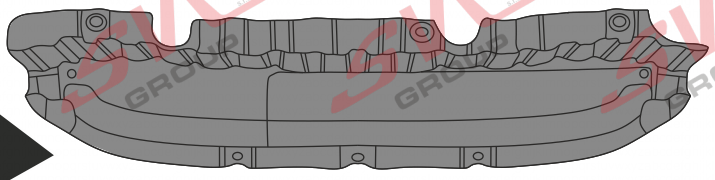
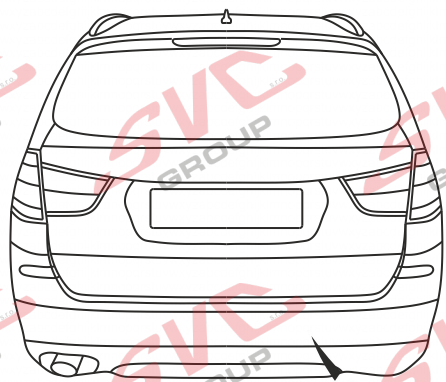

11.

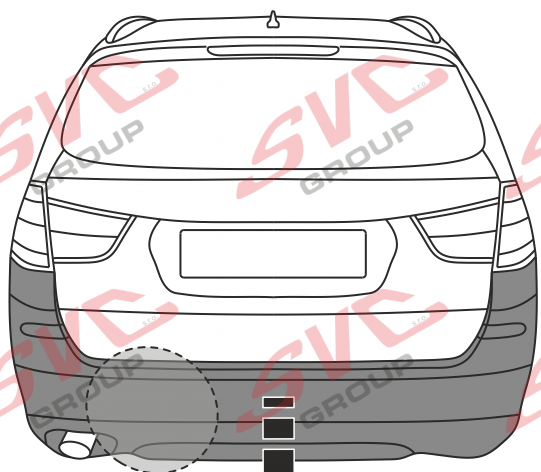

12.

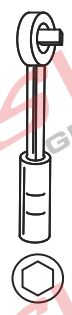
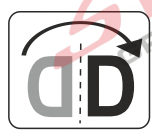
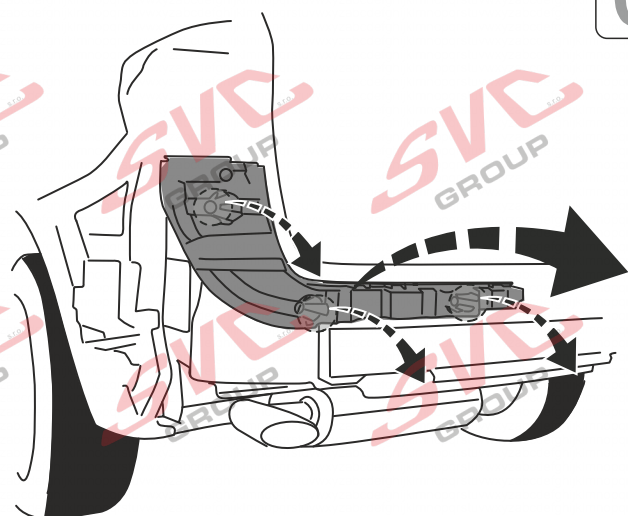
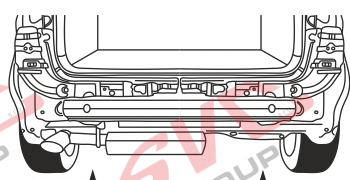

10

BMW x3



13.

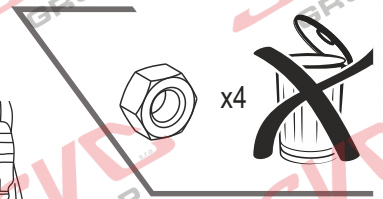
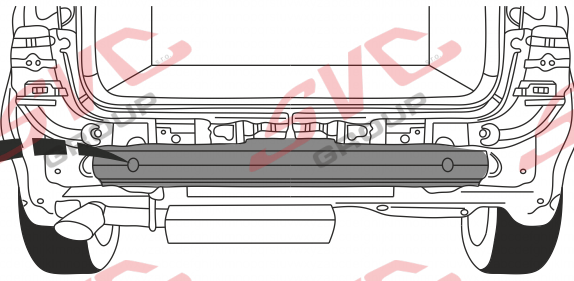

x4

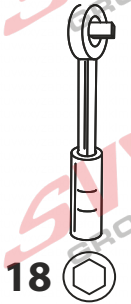

18

14.

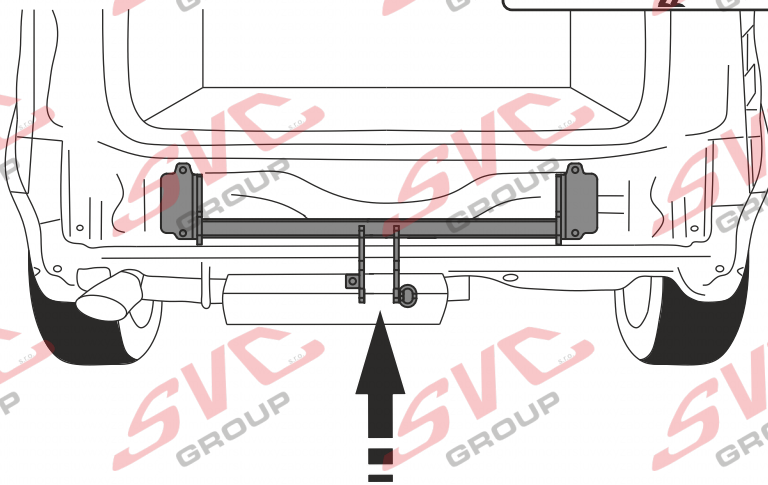
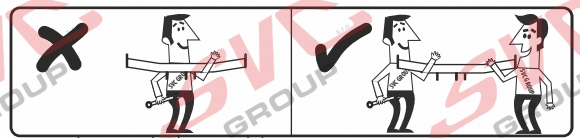

15.

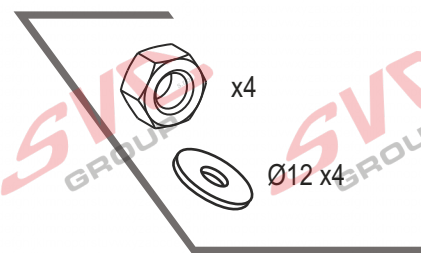

x4

Ø12 x4

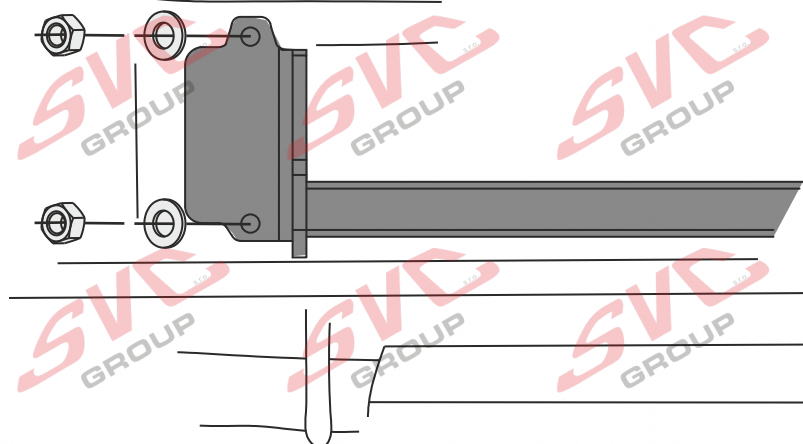
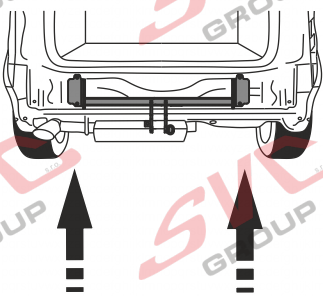

18





16.

Plart pod nárazníkem

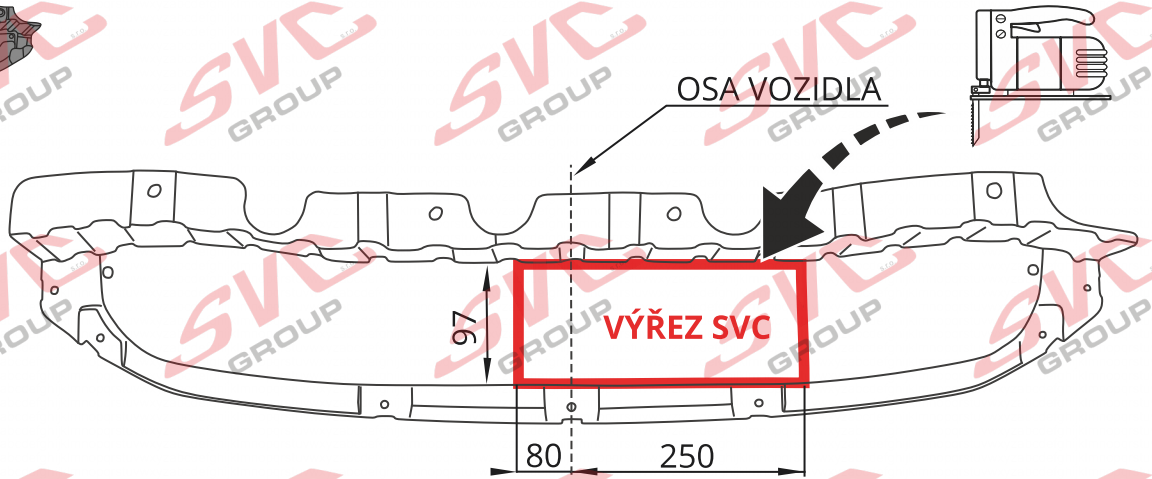
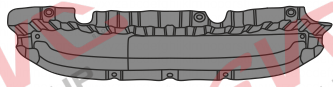

17.

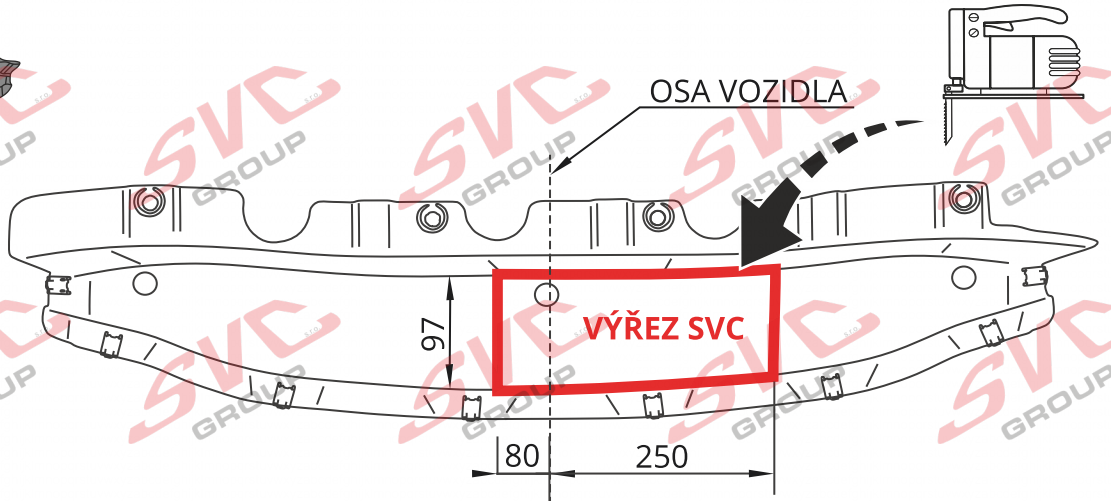
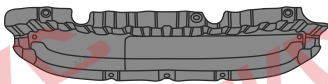

18.

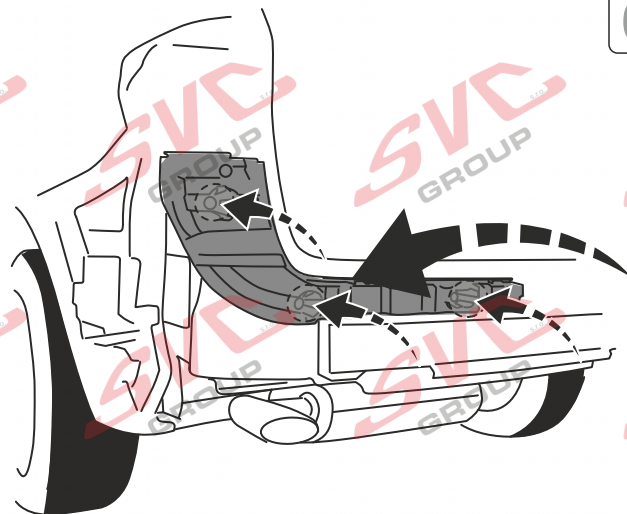
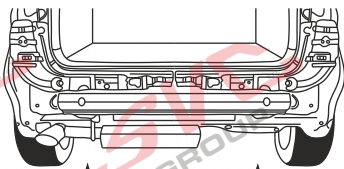

BMW x3





19.

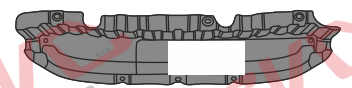
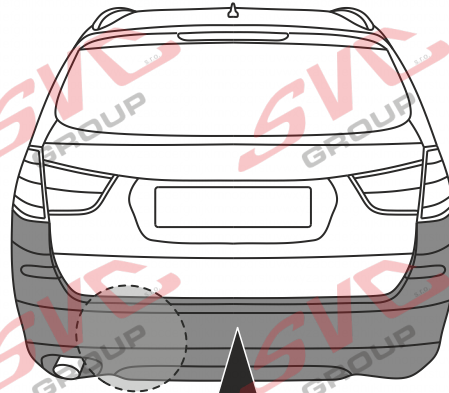

21.

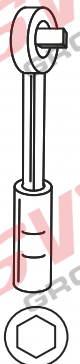
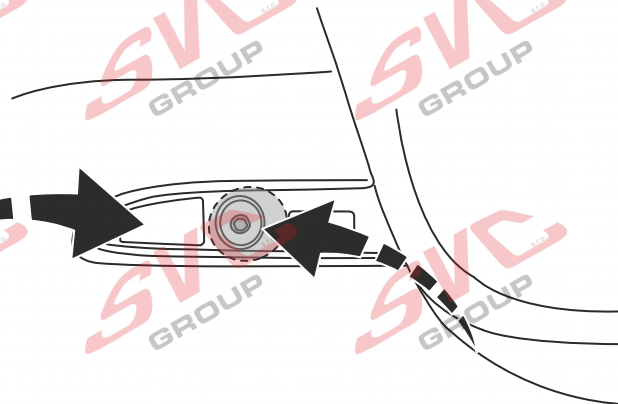
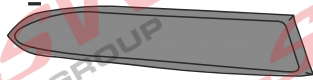
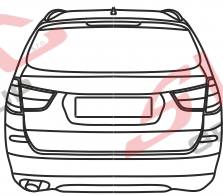

8



22.

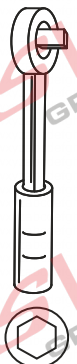
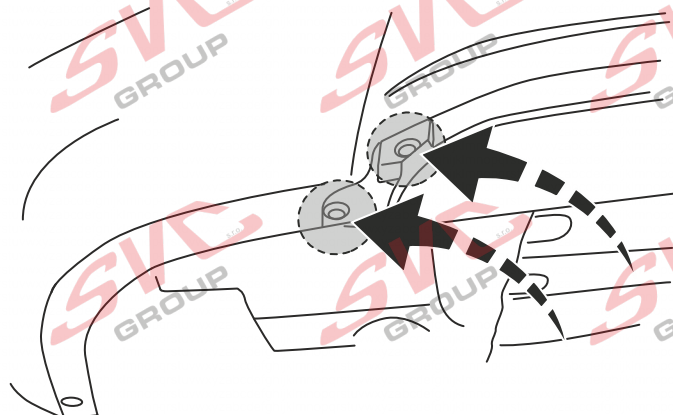
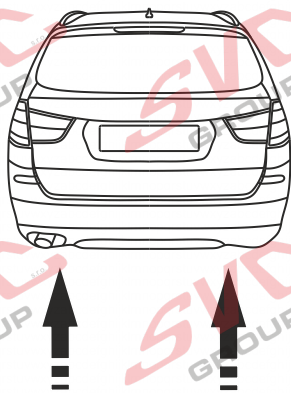

8



23.

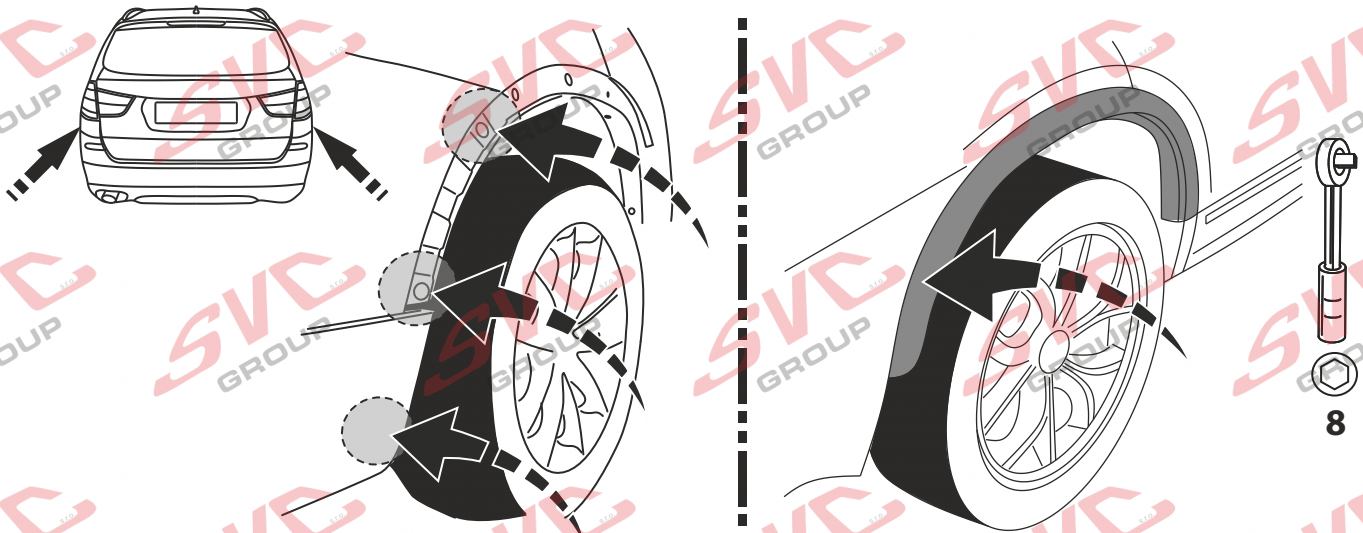

24.

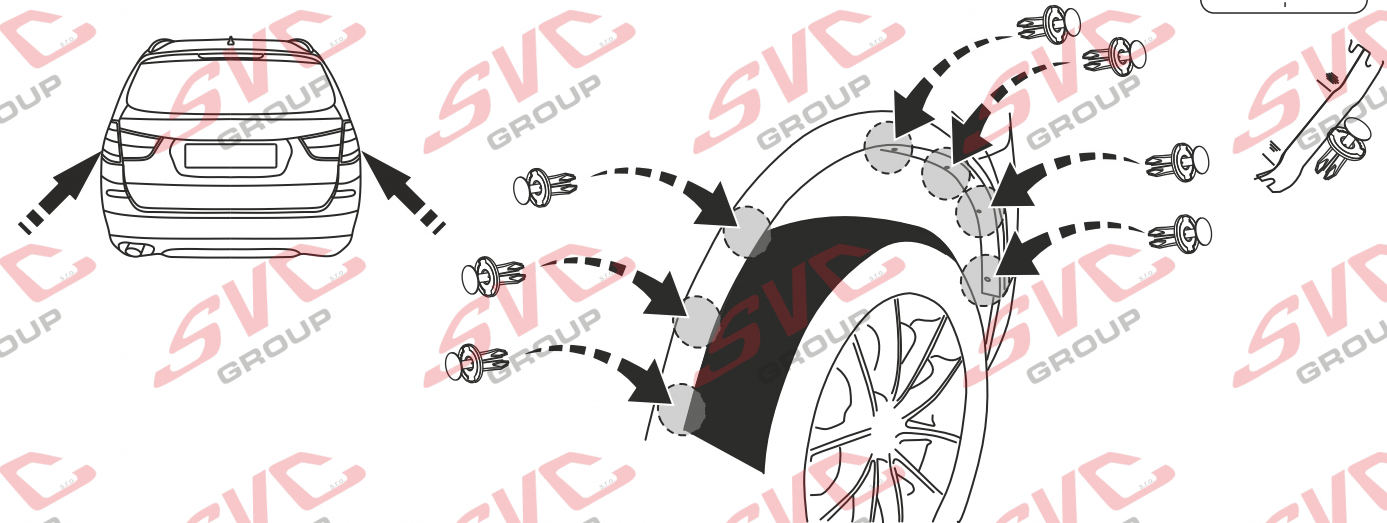

25.

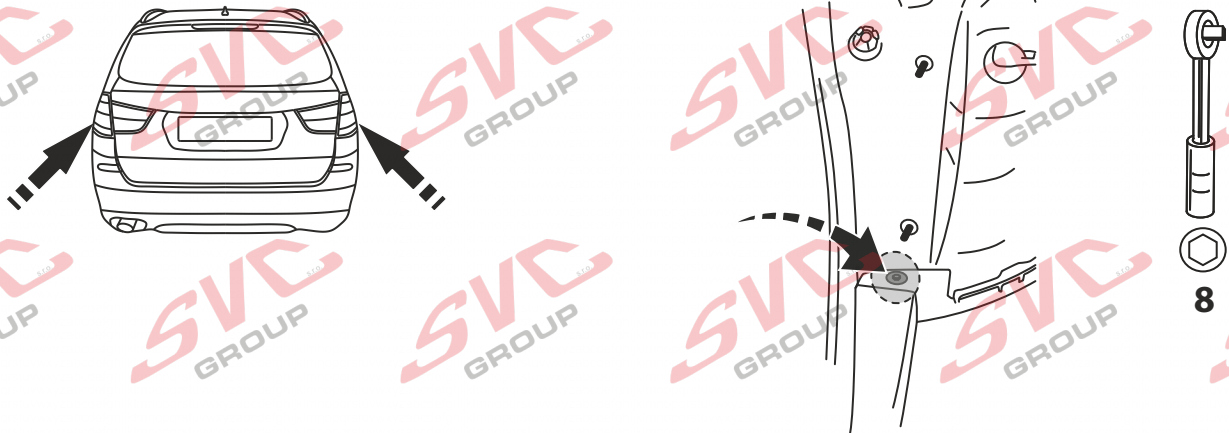

 **26.**

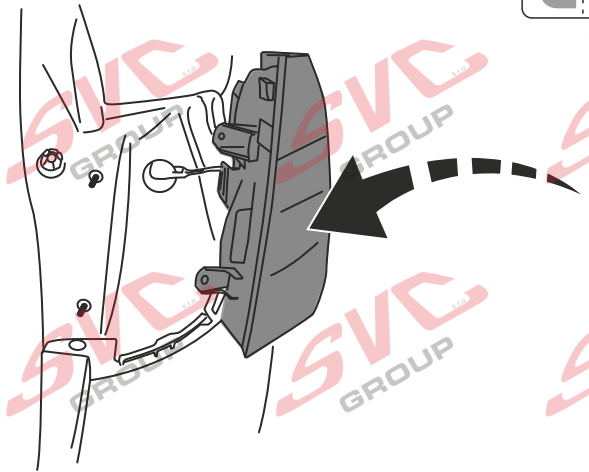
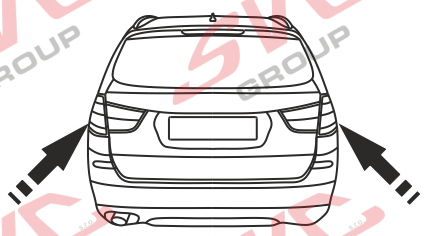

 **27.**

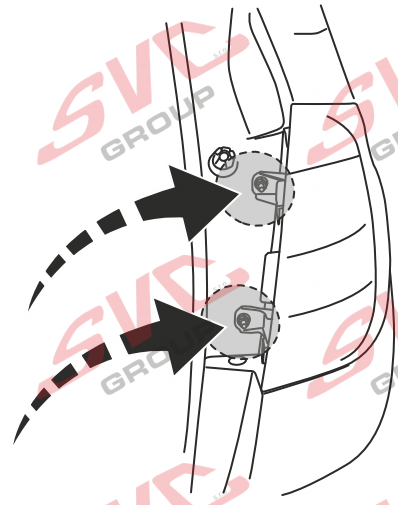
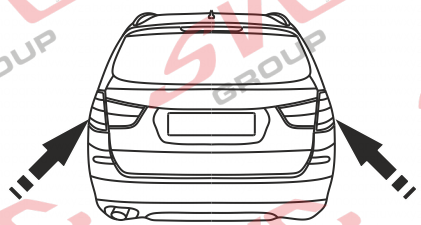

10

 **28.**

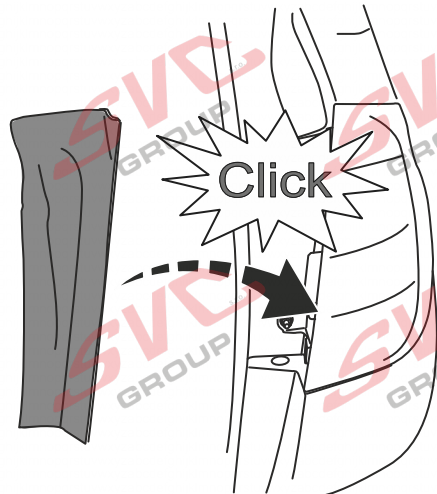
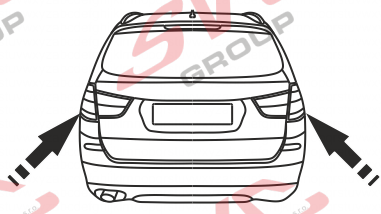

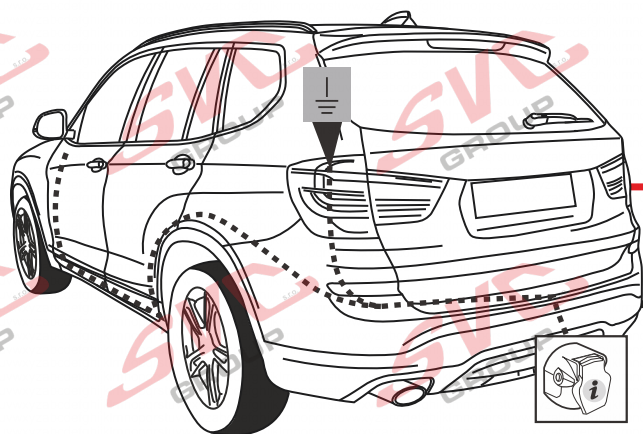

BMW x3

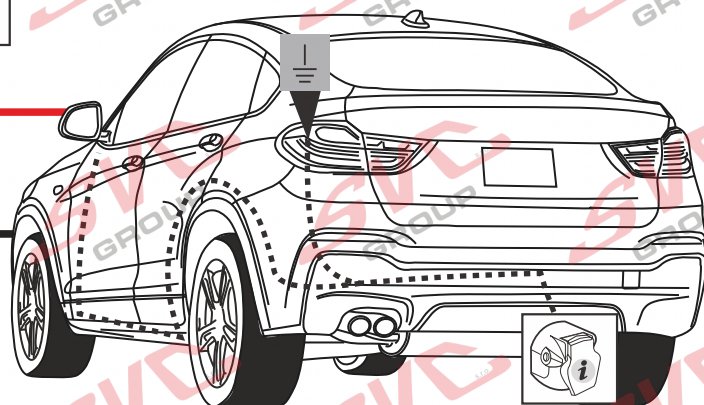

BMW x4

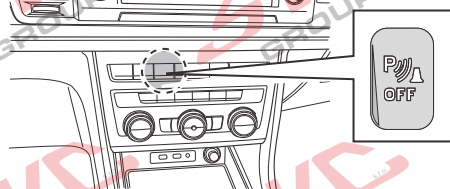

Informace pro odpojování couvacích senzorů PDC pro tažné zařízení

Vypínač pro vypínání couvacích senzorů PDC je umístěn na palubní desce vozu.

Nemusíte tedy pracně na elektro instalaci vozu napojovat odpojování couvacích senzorů PDC a zpětných kamer od elektro přípojky tažných zařízení.

Pokud chcete senzory vypnout, použijte vypínač na palubní desce.

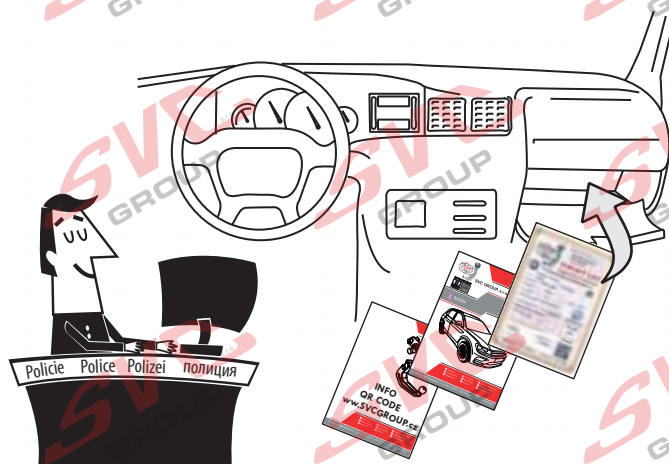
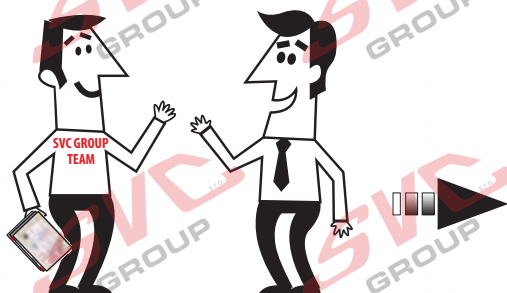

SVC GROUP

Děkuje za důvěru / Դակույе за до́веру

Thank you for your trust / Danke Für dein Vertrauen

Merci pour votre conance / Grazie per la tua ducia

Tankewol foar jo fertrouwen / Спасибо за ваше доверие

Registrace / Registrácia

Registration / Registrierung

Inscription / Registrazione

Rekisteröinti / Регистрация





BMW x3 F25
BMW x3 G01
BMW x4 F26



2010 -> 10/2017
1/2017 ->
2010 -> 10/2018

N-1

ES Manual de montaje Para obtener instrucciones detalladas de instalación y condiciones del producto, escanee el código QR

1. Desmonte los focos traseros, parachoques y su refuerzo de acero (no hará falta más).
2. En el puesto del refuerzo de acero instale el soporte principal del equipo de tiro por medio de las tuercas existentes M12(BMW) a través de arandelas grandes. Apriete según los pares de apriete. Enderece bien el equipo de tiro.
3. Haga el recorte del parachoques según el tipo del vehículo. Monte de vuelta todas las piezas desmontadas según el punto No. 1.

IT Istruzioni di montaggio per la Per istruzioni di installazione dettagliate e condizioni del prodotto, eseguire la scansione del codice

1. Smontare i fanali posteriori, il paraurti e il suo rinforzo di acciaio (non sarà più necessario).
2. In luogo del rinforzo di acciaio montare il supporto principale del dispositivo di traino usando i dadi esistenti M12 (BMW) e rondelle di grande dimensione. Serrare con le coppie di serraggio prescritte. Far attenzione all'allineamento del dispositivo di traino.
3. Secondo il tipo del veicolo fare un intaglio nel paraurti. Rimontare tutti i componenti smontati nel punto 1.

NO Monteringsanvisning For installasjonsinstruksjoner og produktbetingelser, skann QR-koden

1. Demontér baklys, støtfanger og dens forsterkning av stål (den vil ikke lenger trenges).
2. Montér på stedet etter forsterkningen av stål trekkutstyrets hovedbæreelement og det ved hjelp av de eksisterende mutterne av typen M12(BMW) via underlagene med store ater. Stram i samsvar med de foreskrevde tiltrekkingmomentene. Vær nøye med balansering av trekkutstyret.
3. Lag en støtfangerutskjæring alt etter hvilken biltype det er snakk om. Montér på plass igjen alle de delene som ble demontert i punkt nr. 1.

NL Montagehandleiding Scan de QR-code voor installatie-instructies en instructies voor productcondities

1. Verwijder de achterlichten, bumper en de stalen versterkingsdeel (deze is niet langer nodig).
2. Zet in plaats van de vorige versterker de hoofdligger van de trekhaak met behulp van M12 moeren (BMW) vast onder toepassing van extra grote ringen. Lijn de trekhaak uit en schroef deze overeenkomstig de aanbevolen aanhaalmomenten aan.
3. Maak een uitsparing in de bumper, afhankelijk van het model van de auto. Plaats alle volgens punt 1 verwijderde onderdelen terug.

HU Szerelési útmutató A telepítési és a termékfeltételekkel kapcsolatos utasításokat olvassa be a QR-kódot

1. Távolítsa el a hátsó lámpákat, a lökhárítót és a acél tartót (erre már nem lesz szüksége).
2. A fém tartó helyére szerelje fel a vonóhorog fő hordozóját a meglévő M12(BMW) anyák segítségével a nagy felületű alátéteken át. Húzza meg a meghúzási nyomatékok szerint. Ügyeljen a vonóhorog egyensúlyozására.
3. Vágja ki jármű típus szerint a lökhárító részét. Helyezze vissza az 1. lépésben eltávolított alkatrészeket.

RU Инструкция по монтажу Подробные инструкции по установке и условиям продукта отсканируйте QR-к

1. Снимите задние фонари, бампер и его стальной усилитель (он больше не потребуется.).
2. На месте бывшего усилителя закрепите главную балку фаркопа с помощью гаек М12 (BMW) с использованием увеличенных шайб. Выровняйте фаркоп и затяните в соответствии с предписанными моментами затяжки.
3. Сделайте в бампере вырез в зависимости от модели автомобиля. Верните на место все части, демонтированные согласно пункту 1.



SVC GROUP s.r.o. Průmyslová zóna - 179 547 01 Náchod-ČR www.svcgroup.cz

tel.: +420 491 421 021
+420 491 421 022
e-mail: svc@svcgroup.cz
mob.: +420 603 360 607

SVC GROUP ©- 05/19

QR kódem stáhnete rozšířený montážní návod / Verwenden Sie den QR-Code, um die erweiterte Montageanleitung herunterzuladen



T-1

CZ Informace k provozu / homologaci

Výrobek je vyráběn dle platných norem EHK-55 R pro prodej ve státech EU. Informace pro použití, provoz a záruky pro tažné zařízení naleznete na našem webu, www.svcgroup.cz

Technické informace > Tažné zařízení > Všeobecné podmínky použití výrobku. Nebo si je stáhněte aplikace přes příložený QR-cod

Součástí dodávky tažného zařízení je dodán TYPOVÝ LIST. Tento typový list slouží pro zapsání výrobku do technického průkazu vozidla, a obsahuje základní podmínky pro použití výrobku.

Typový list slouží i jako záruční lis proto jej uschovejte v dokumentaci vozidla.

SK Informácie na prevádzku / homologáciu

Výrobok je vyrábaný podľa platných noriem EHK-55 R pre predaj v štátoch EÚ. Informácie pre použitie, prevádzku a záruky pre ťažné zariadenie nájdete na našom webe, www.svcgroup.cz

Technické informácie > Ťažné zariadenie > Všeobecné podmienky použitia výrobku. Alebo si ich stiahnite aplikácie cez priložený QR-cod

Súčasťou dodávky ťažného zariadenia je dodaný TYPOVÝ LIST. Tento typový list slúži pre zapísanie výrobku do technického preukazu vozidla, a obsahuje základné podmienky použitia výrobku.

Typový list slúži aj ako záručný lis preto ho uschovajte v dokumentácii vozidla.

EN Operating / homologation information

The product is manufactured according to the applicable EHK-55 R standards for sale in EU countries. Information on the use, operation and warranties for the towbar can be found on our website, www.svcgroup.com

Technical information > Towing hitch > General conditions of use. Or download them via QR-cod

The towing device is supplied with a TYPE SHEET. This data sheet is used to enter the product in the vehicle registration document and contains the basic conditions for use of the product.

The data sheet also serves as a warranty press, so keep it in the vehicle documentation.

DE Betriebs / Zulassungsinformationen

Das Produkt wird gemäß den geltenden EHK-55 R-Standards für den Verkauf in EU-Ländern hergestellt. Informationen zu Verwendung, Betrieb und Gewährleistung der Anhängerkupplung finden Sie auf unserer Website www.svcgroup.com

Technische Informationen > Anhängerkupplung > Allgemeine Nutzungsbedingungen. Oder laden Sie sie per QR-Code herunter

Die Anhängervorrichtung wird mit einem TYPENBLATT geliefert. Dieses Datenblatt dient zur Eintragung des Produkts in das Kfz-Kennzeichen und enthält die Grundbedingungen für die Verwendung des Produkts. Das Datenblatt dient auch als Garantiepresse. Bewahren Sie es daher in der Fahrzeugdokumentation auf.

HU Üzemeltetési / homologációs információk

Das Produkt wird gemäß den geltenden EHK-55 R-Standards für den Verkauf in EU-Ländern hergestellt. Informationen zu Verwendung, Betrieb und Gewährleistung der Anhängerkupplung finden Sie auf unserer Website www.svcgroup.com

Technische Informationen > Anhängerkupplung > Allgemeine Nutzungsbedingungen. Oder laden Sie sie per QR-Code herunter

Die Anhängervorrichtung wird mit einem TYPENBLATT geliefert. Dieses Datenblatt dient zur Eintragung des Produkts in das Kfz-Kennzeichen und enthält die Grundbedingungen für die Verwendung des Produkts. Das Datenblatt dient auch als Garantiepresse. Bewahren Sie es daher in der Fahrzeugdokumentation auf.

FR Informations d'exploitation / homologation

Le produit est fabriqué conformément aux normes EHK-55 R applicables pour la vente dans les pays de l'UE. Des informations sur l'utilisation, le fonctionnement et les garanties de l'attelage sont disponibles sur notre site Web, www.svcgroup.com.

Informations techniques > Attelage de remorquage > Conditions générales d'utilisation. Ou téléchargez-les via QR-cod

Le dispositif de remorquage est fourni avec une feuille de type. Cette fiche technique est utilisée pour entrer le produit dans le certificat d'immatriculation du véhicule et contient les conditions de base pour l'utilisation du produit. La fiche technique sert également de presse de garantie, conservez-la dans la documentation du véhicule.

IT Informazioni sull'operazione / omologazione

Il prodotto è fabbricato secondo le norme EHK-55 R applicabili in vendita nei paesi dell'UE. Informazioni sull'uso, il funzionamento e le garanzie per il gancio di traino sono disponibili sul nostro sito Web www.svcgroup.com

Informazioni tecniche > Gancio di traino > Condizioni generali d'uso. Oppure scaricali tramite QR-cod

Il dispositivo di rimorchio viene fornito con una SCHEDA TIPO. Questa scheda tecnica viene utilizzata per inserire il prodotto nel certificato di immatricolazione del veicolo e contiene le condizioni di base per l'uso del prodotto. La scheda tecnica funge anche da stampa di garanzia, quindi conservala nella documentazione del veicolo.



SVC GROUP s.r.o. Průmyslová zóna - 179 547 01 Náchod-ČR

www.svcgroup.cz
e-mail: svc@svcgroup.cz

Tel.: +420 491 421 021
+420 491 421 022
mob.: +420 603 360 607

SVC GROUP © - 05/19

QR kódem stáhněte rozšířený montážní návod / QR-kóddal letöltheti a kibővített összeszerelési utasításokat



T-2

NL Monteringsanvisningar

Het product is vervaardigd volgens de toepasselijke EHK-55 R-normen voor verkoop in EU-landen. Informatie over het gebruik, de werking en de garanties voor de trekhaak vindt u op onze website, www.svcgroup.com *Technische informatie* > *Trekhaak* > *Algemene gebruiksvoorwaarden*. Of download ze via QR-cod
Het sleepapparaat wordt geleverd met een TYPE BLAD. Dit gegevensblad wordt gebruikt om het product in het voertuigregistratiedocument in te voeren en bevat de basisvoorwaarden voor het gebruik van het product. Het gegevensblad dient ook als garantiepers, dus bewaar het in de voertuigdocumentatie.

ES Instrucciones de montaje

El producto se fabrica de acuerdo con los estándares EHK-55 R aplicables para la venta en países de la UE. Puede encontrar información sobre el uso, el funcionamiento y las garantías de la barra de remolque en nuestro sitio web, www.svcgroup.com *Información técnica* > *Enganche de remolque* > *Condiciones generales de uso*. O descárguelos a través de QR-cod
El dispositivo de remolque se suministra con una HOJA DE TIPO. Esta hoja de datos se utiliza para ingresar el producto en el documento de registro del vehículo y contiene las condiciones básicas para el uso del producto. La hoja de datos también sirve como una prensa de garantía, por lo tanto, consérvela en la documentación del vehículo.

FIN Montage-instructie

Tuote on valmistettu EU-maissa myytävien EHK-55 R -standardien mukaisesti. Tietoja vetokoukun käytöstä, käytöstä ja takuista löytyy verkkosivuiltamme www.svcgroup.com *Tekniset tiedot* > *Vetokoukku* > *Yleiset käyttöolosuhteet*. Tai lataa ne QR-koodin kautta
Hinauslaite toimitetaan TYYPPI-ARKKI. Tätä lomaketta käytetään tuotteen syöttämiseen ajoneuvon rekisteröintitodistukseen, ja se sisältää tuotteen käytön perusedellytykset. Tietolomake toimii myös takuupuristimena, joten säilytä se ajoneuvon dokumenteissa.

SL

Izdelek je izdelan po veljavnih standardih EHK-55 R za prodajo v državah EU. Informacije o uporabi, delovanju in garancijah za vlečno ploščo najdete na našem spletnem mestu www.svcgroup.com *Tehnični podatki* > *Vlečna kljuka* > *Splošni pogoji uporabe*. Ali pa jih prenesite preko QR-kod
Vlečna naprava je opremljena s TIPNIM LISTOM. Ta podatkovni list se uporablja za vnos izdelka v registracijski dokument vozila in vsebuje osnovne pogoje za uporabo izdelka. Podatkovni list služi tudi kot garancijski tisk, zato ga hranite v dokumentaciji vozila.

NOR Drifts- / homologasjonsinformasjon

Produktet er produsert i henhold til gjeldende EHK-55 R standarder for salg i EU-land. Informasjon om bruk, drift og garantier for tilhengerfeste finner du på vår hjemmeside, www.svcgroup.com *Teknisk informasjon* > *Tilhengerfeste* > *Generelle bruksbetingelser*. Eller last dem ned via QR-koding
Tøaeanordningen leveres med TYPEBLAD. Dette databladet brukes til å oppgi produktet i kjøretøyets registreringsbevis og inneholder de grunnleggende betingelsene for bruk av produktet. Databladet fungerer også som garantipresse, så hold det i bilens dokumentasjon.

PL Informacje dotyczące pracy / homologacji

Produkt jest wytwarzany zgodnie z obowiązującymi normami EHK-55 R na sprzedaż w krajach UE. Informacje na temat użytkowania, obsługi i gwarancji na hak holowniczy można znaleźć na naszej stronie internetowej www.svcgroup.com *Informacje techniczne* > *Żaczep holowniczy* > *Ogólne warunki użytkowania*. Lub pobierz je za pomocą kodu QR
Urządzenie holownicze jest dostarczane z ARKUSZEM TYPU. Ta karta danych służy do wpisania produktu do dokumentu rejestracyjnego pojazdu i zawiera podstawowe warunki użytkowania produktu. Karta danych służy również jako prasa gwarancyjna, dlatego przechowuj ją w dokumentacji pojazdu.

RU Информация о работе /омологации

El producto se fabrica de acuerdo con los estándares EHK-55 R aplicables para la venta en países de la UE. Puede encontrar información sobre el uso, el funcionamiento y las garantías de la barra de remolque en nuestro sitio web, www.svcgroup.com *Información técnica* > *Enganche de remolque* > *Condiciones generales de uso*. O descárguelos a través de QR-cod
El dispositivo de remolque se suministra con una HOJA DE TIPO. Esta hoja de datos se utiliza para ingresar el producto en el documento de registro del vehículo y contiene las condiciones básicas para el uso del producto. La hoja de datos también sirve como una prensa de garantía, por lo tanto, consérvela en la documentación del vehículo.



SVC GROUP s.r.o. Průmyslová zóna - 179 547 01 Náchod-ČR

www.svcgroup.cz
e-mail: svc@svcgroup.cz

Tel.: +420 491 421 021
+420 491 421 022
mob.: +420 603 360 607
SVC GROUP © - 05/19

QR kódem stáhnete rozšířený montážní návod / Con il codice QR è possibile scaricare le istruzioni di assemblaggio estese



CZ Pozor informace k záruce
SK Pozor informácie k záruke
EN Note the warranty information
DE Beachten Sie die Garantieinformationen

HU Vegye gyelembe a jótállási információkat
FR Notez les informations de garantie
IT Nota le informazioni sulla garanzia
NL Let op de garantie-informatie

ES Atención
FIN Huomio
PL Uwaga
RU Внимание

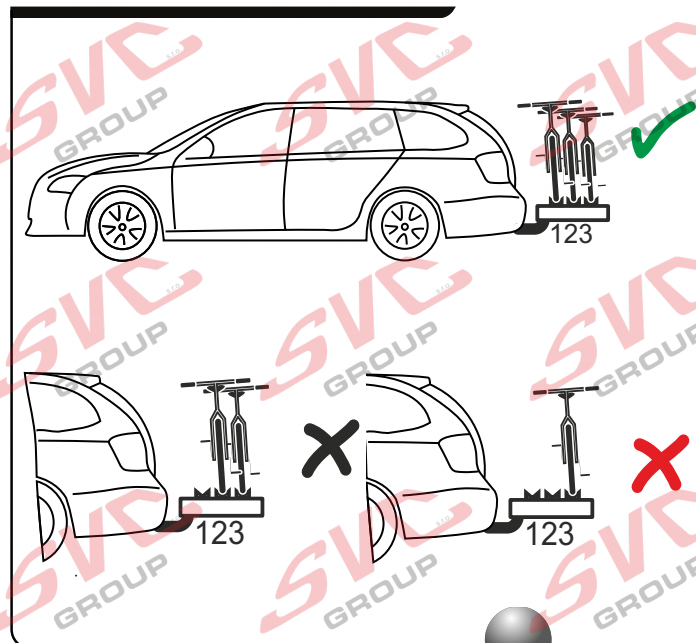
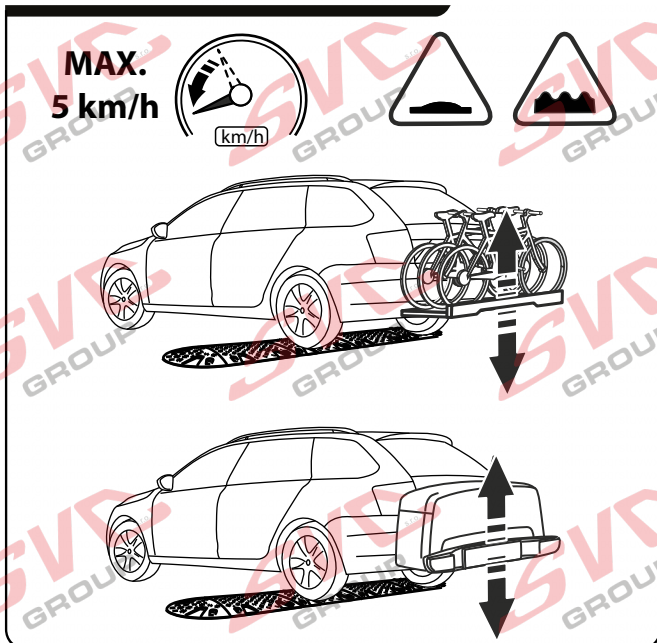
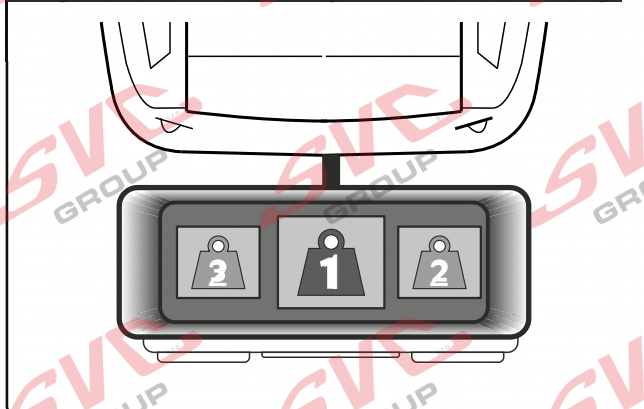
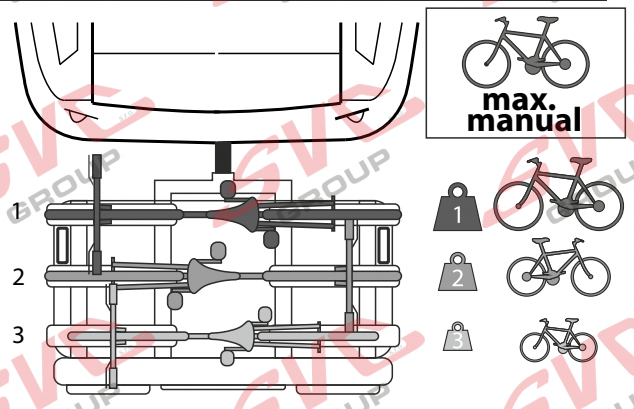
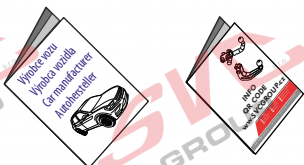
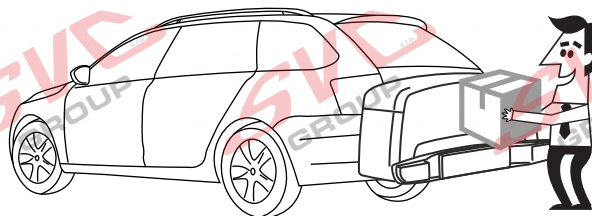
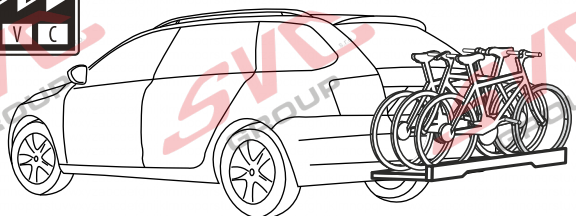

Vysokov 179
 547 01 Náchod, Česká Republika

+420 603 360 607 +420 491421021



www.svcgroup.cz

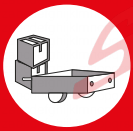

- CZ Pozor informace k záruce
- SK Pozor informácie k záruke
- EN Note the warranty information
- DE Beachten Sie die Garantieinformationen

- HU Vegye gyelembe a jótállási információkat
- FR Notez les informations de garantie
- IT Nota le informazioni sulla garanzia
- NL Let op de garantie-informatie

- ES Atención
- FIN Huomio
- PL Uwaga
- RU Внимание

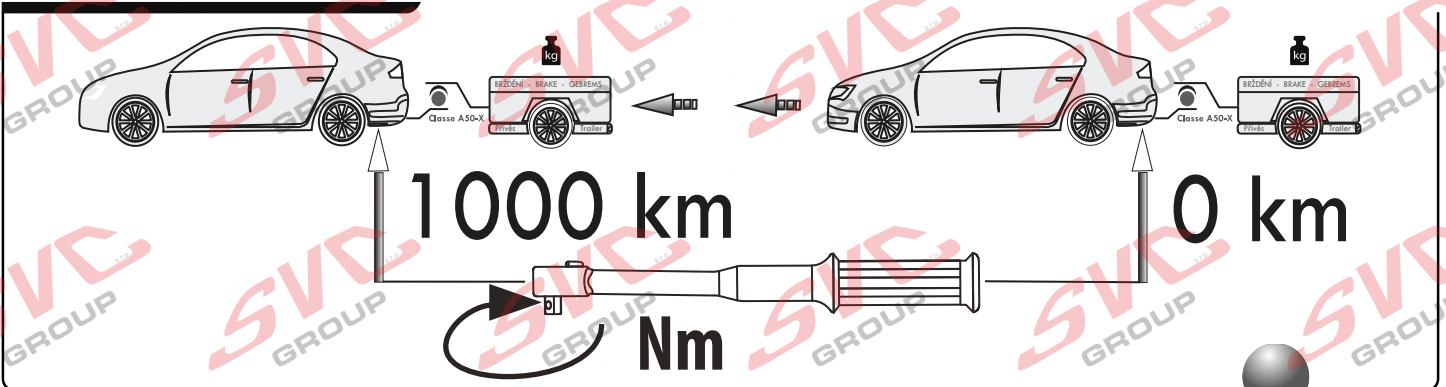
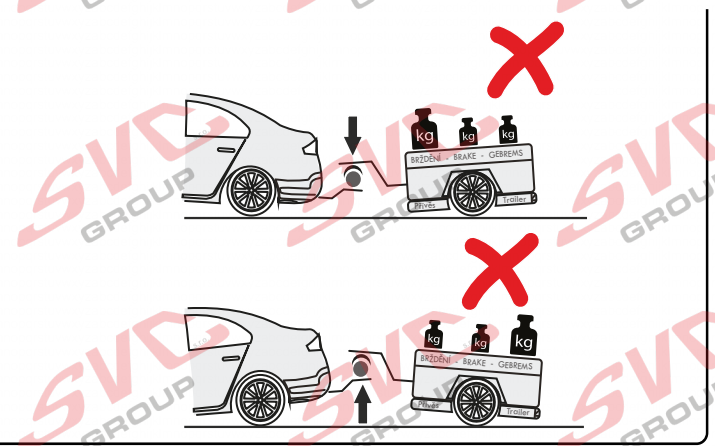
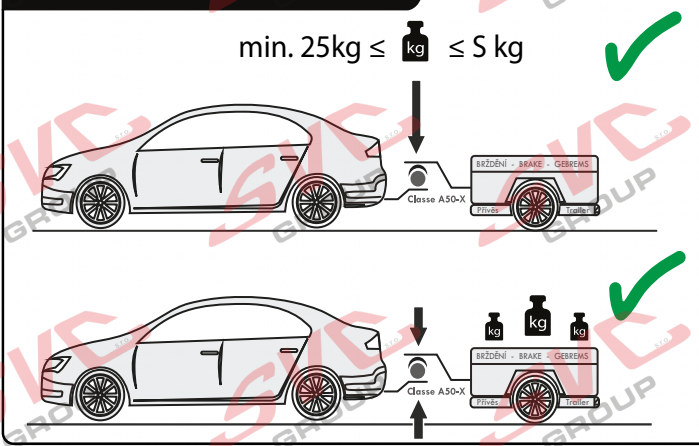
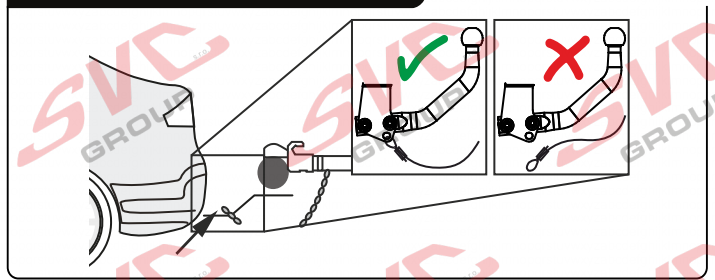
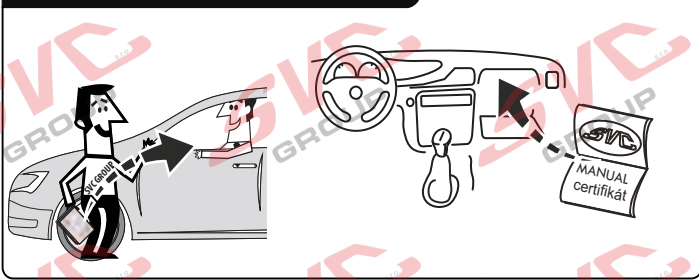
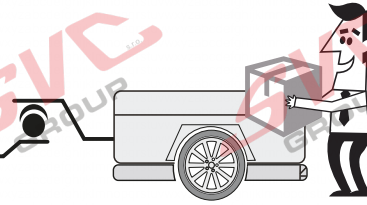
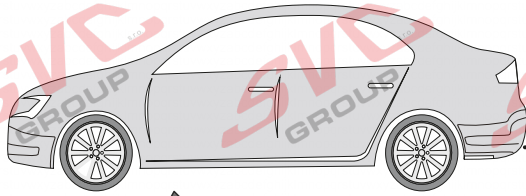

Vysokov 179
547 01 Náchod, Česká Republika

+420 603 360 607 +420 491421021



www.svcgroup.cz

SVC GROUP ©-08-2019

Service Vitver Centrum

Nevíte si rady? Potřebujete poradit?

Náš zákaznický servis je vám k dispozici

 +420 491 421 021

 svc@svcgroup.cz



Opravdový specialista a Certifikovaný výrobce tažných zařízení s největším sortimentem v ČR. Rodinná firma s více jak 30letou ověřenou tradicí výroby, prodeje a montáže.

www.svcgroup.cz