

Montážní návod

(Montážny návod, Fitting instruction, Montageanleitung,
Istruzioni di montaggio, Monteringshandledning,
Asennusohje, Instruction de montage,
Montegehandleiding, Инструкция по установке)



Tažné zařízení

BMW X3 11/2017->

Ťažné zariadenie
Towbars
Trekhaak
Anhängerkupplung de
Dispositif d'attelage
Equipo de remolque
Sprzęt holowniczy
Hinauslaitteet
Буксирное оборудование



výrobce / dodavatel

SVC Group s.r.o.

Odkaz na produkt:

<https://www.svcgroup.cz/tazne-zarizeni-sro-uby-pevny-skoda-rapid-monte-carlo-10-2012-2018-p7283-v960>



www.svcgroup.cz



CZ - Tažné zařízení / SK - Ťažné zariadenie / GB - Towbars / PL - Haki holownicze
 DE - Anhängervorrichtungen / FR - Attelages / SPA - Ganchos / HUN - Vonohorgok
 RUS/FIN/LIT - Фаркопы / RO - Cârlig de remorcare

TYP VTZ 001-504 VTZ 002-504 VTZ 003-504

www.svcgroup.cz



SVC GROUP s.r.o
 Průmyslová zóna 179
 547 01 Náchod
 Česká Republika



BMW X3 typ - F25

BMW X3 + GX3 typ - G01

BMW X4 typ - F26



2010 -> 2017

2017 ->

2010 -> 10/2018



1->2,0 h



2->2,5 h

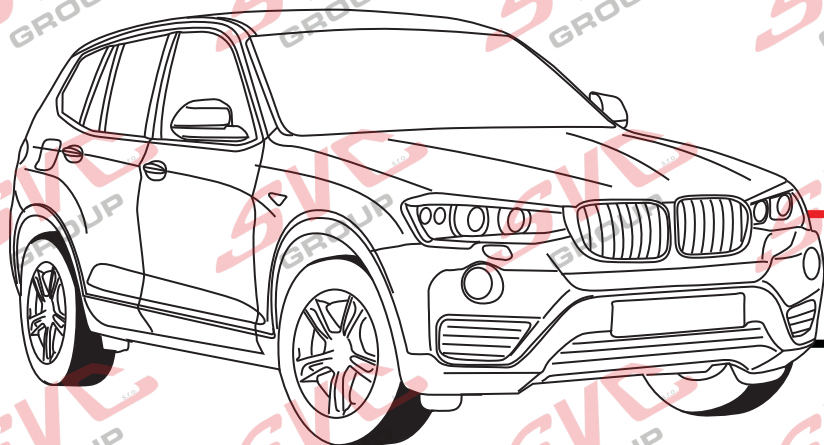

BMW x3

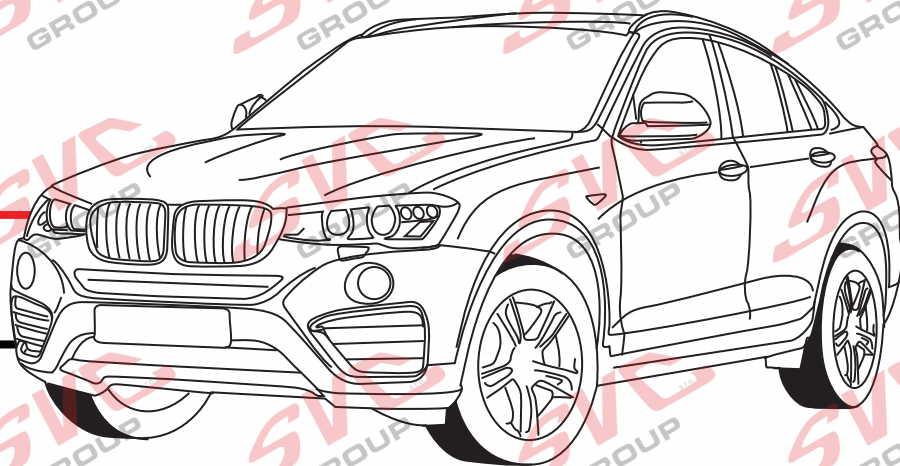

BMW x4



CZ Pro podrobné montážní instrukce a podmínky výrobku si naskenujte QR kód
 SK Pre podrobné montážne pokyny a podmienky produktu si môžete skenovať QR kód
 GB For detailed installation instructions and product conditions, scan the QR code
 DE Scannen Sie den QR-Code, um detaillierte Installationsanweisungen und Produktbedingungen zu erhalten
 FR Pour des instructions d'installation détaillées et les conditions du produit, scannez le code QR
 ITA Per istruzioni di installazione dettagliate e condizioni del prodotto, eseguire la scansione del codice QR
 PL Aby uzyskać szczegółowe instrukcje dotyczące instalacji i warunki produktu, zeskanuj kod QR
 SP Para obtener instrucciones detalladas de instalación y condiciones del producto, escanee el código QR
 NL Voor gedetailleerde installatie-instructies en productvoorwaarden, scan de QR-code
 FIN Tarkemmat asennusohjeet ja tuotteen ehdot on tarkistettava QR-koodilla
 HU A részletes telepítési utasítások és a termék feltételei között olvassa el a QR kódot
 SLO Za podrobna navodila za namestitve in pogoje izdelka skenirajte kodo QR
 RU Подробные инструкции по установке и условиям продукта отсканируйте QR-код.

SVC GROUP ©-11/19

e-mail: svc@scvgroup.cz Tel.:+420 491421021 +420 491421022 mob.: +420 603360607



BMW x3 F25
 BMW x3 G01
 BMW x4 F26



2010 -> 10/2017
 11/2017 ->
 2010 -> 10/2018



6007/11



2500/115 D 12,14



55R-01-0552



1,5->2,0 h



2->2,5 h



VTZ 001-504

15,40



A-504-2021



VTZ 002-504

15,80



A-504-2021



VTZ 003-504

18,40



AV-504-2021

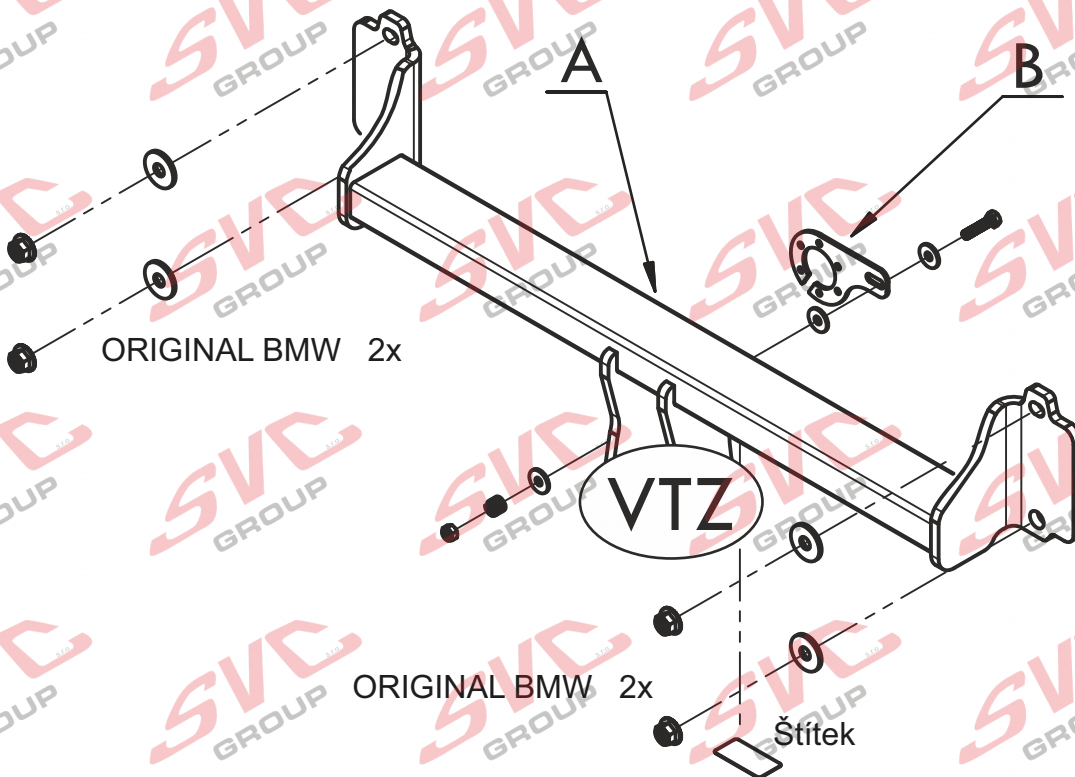

ORIGINAL BMW 2x

ORIGINAL BMW 2x

Štítek

	A	x1			
Krátké	B	x1		Ø12	4ks





BMW x3 F25
 BMW x3 G01
 BMW x4 F26



2010 -> 10/2017
 11/2017 ->
 2010 -> 10/2018



VTZ 001-504



VTZ 002-504



VTZ 003-504

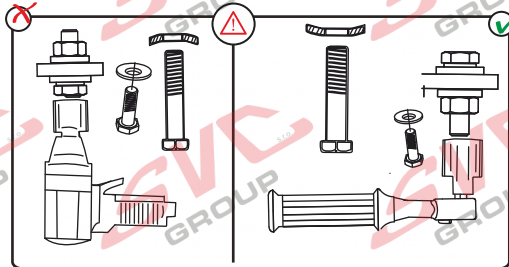
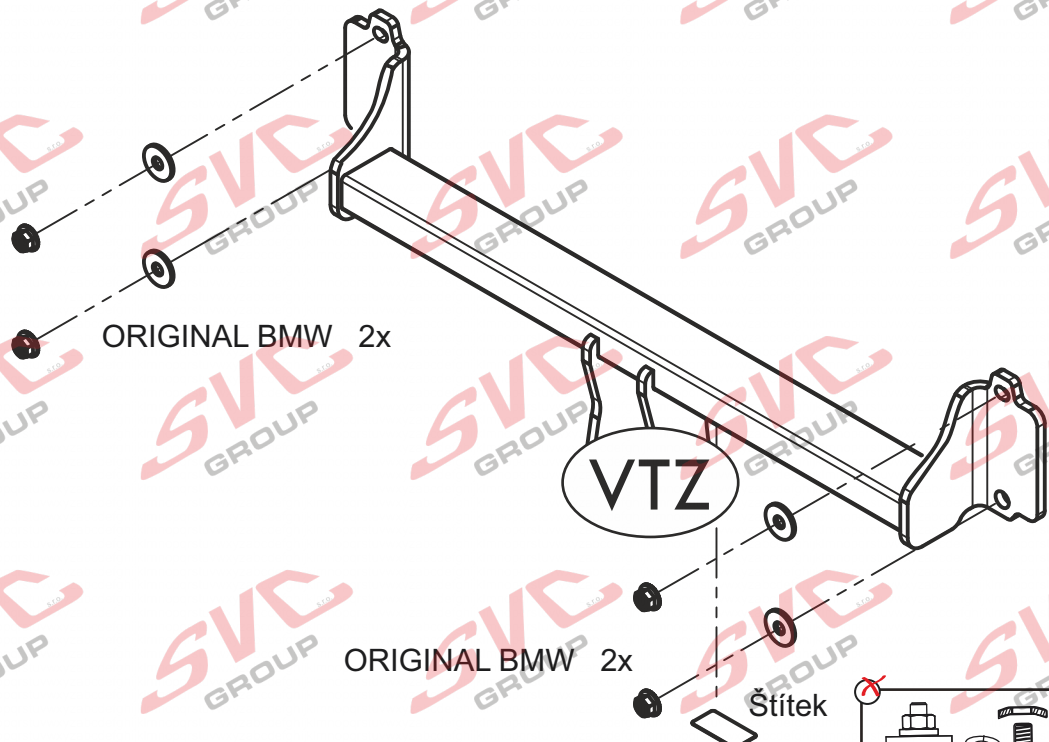
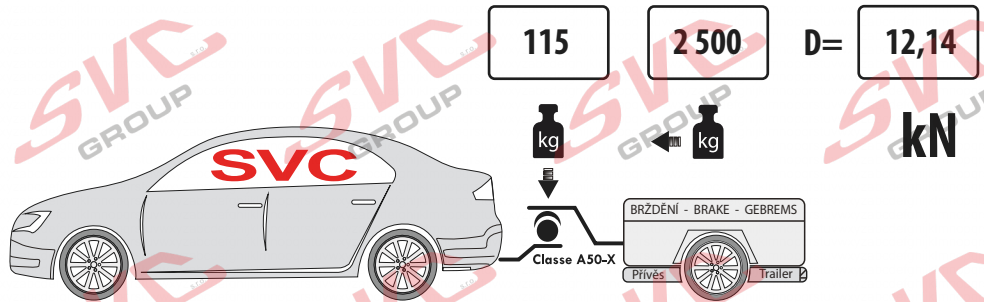

Max -> 1000 km 0 km

	Nm		
Pevnost	8,8	10,9	12,9
M6	9,7	14,3	16,1
M8	24,5	35,9	42,0
M10	48,4	71,0	83,0
M12	84,0	123,0	144,0
M14	133,0	196,0	229,0
M16	137,0	307,0	359,0

Diagram of a torque wrench and a manual. A green checkmark is next to the torque wrench, and a red X is next to the manual.

Homologace EHK 55-R 55R-01-0552

QR code

Approval Number Class **A50-X**

Type 00-xxxx

D-Value kN

Series Vert.Id kg

www.svcgroup.cz - CZECH REPUBLIC

CZ Informace k provozu / homologaci	NL Monteringsanvisningar
SK Informácie na prevádzku / homologáciu	ES Instrucciones de montaje
EN Operating / homologation information	FIN Montage-instructie
DE Betriebs- / Zulassungsinformationen	SV Asennusohjeet
HU Üzemeltetési / homologációs információk	NOR Drifts- / homologasjonsinformasjon
FR Informations d'exploitation / homologatio	PL Informacje dotyczące pracy / homologacji
IT Informazioni sull'operazione / omologazio	RU Информация о работе / омологации



SVC GROUP s.r.o.

Průmyslová zóna - 179
 547 01 Náchod-ČR

www.svcgroup.cz
 e-mail: svc@svcgroup.cz

Tel.: +420 491 421 021
 +420 491 421 022
 mob.: +420 603 360 607
 SVC GROUP ©



BMW x3 F25
BMW x3 G01
BMW x4 F26



2010 -> 10/2017
11/2017 ->
2010 -> 10/2018

N-1

CS Montážní návod

Pro podrobné montážní instrukce a podmínky výrobku si naskenujte QR kód

1. Odmontujte zadní světla, nárazník a jeho ocelovou výztuhu (tato již nebude zapotřebí).
2. Na místo po ocelové výztuze namontujte hlavní nosník tažného zařízení za pomoci stávajících matic M12 (BMW) přes velkoplošné podložky. Dotáhněte dle utahovacích momentů. Dbejte na vyrovnaní tažného zařízení.
3. Zhotovte výřez nárazníku dle typu vozidla. Namontujte zpět všechny díly odmontované v bodě č. 1.

EN Installation instructions

For detailed installation instructions and product conditions, scan the QR code

1. Remove rear lights, bumper and its steel stienner (it is no longer needed).
2. Attach the main beam of the tow bar instead of the steel stienner; use existing M12 nuts (BMW) and large-area washers. Tighten to prescribed torques. Mind the alignment of the tow bar.
3. Make a cut-out in the bumper according to the vehicle type. Reinstall all the parts removed within the step 1.

SK Montážny návod

Pre podrobné montážne pokyny a podmienky produktu si môžete skenovať QR kód

1. Demontirajte zadnje luči, odbijač in njegovo jekleno ojačitev (le-ta ne bo več potrebna).
2. Na mesto, kjer je bila jeklena ojačitev, namestite glavni nosilec vlečne kljuka s pomočjo obstoječih matic M12 (BMW) in širokih podložk. Zategnite glede na zatezne momente. Pazite, da bo vlečna kljuka poravnana.
3. Naredite izrez za odbijač glede na tip vozila. Vse dele, demontirane v točki št. 1, montirajte nazaj.

DE Montageanleitung

Scannen Sie den QR-Code, um detaillierte Installationsanweisungen und Produktbedingungen zu erhalten

1. Die Hecklichter, Stoßstange und deren Stahlverstrebung ausbauen (diese wird nicht mehr benötigt).
2. Anstelle der Stahlverstrebung den Hauptträger der Zugeinrichtung mittels der bestehenden Muttern M12 (BMW) und der großächigen Unterlegscheiben montieren. Mit den entsprechenden Anzugsmomenten festziehen. Auf Ausrichtung der Zugeinrichtung achten.
3. Einen Ausschnitt in der Stoßstange gemäß dem Fahrzeugtyp herstellen. Alle im Punkt Nr. 1 ausgebauten Teile wieder einbauen.

PL Instrukcja montażu

Aby uzyskać szczegółowe instrukcje instalacji i warunki produktu, zeskanuj kod QR

1. Demontujemy tylne lampy, zderzak i jego stalowe wzmocnienie (nie będzie już więcej potrzebne).
2. W miejscu stalowego wzmocnienia montujemy belkę główną urządzenia holowniczego za pomocą istniejących nakrętek M12 (BMW) przez podkładki wielkopowierzchniowe. Nakrętki dokręcamy z zachowaniem zalecanych momentów dokręcania. Pamiętajmy o wykonaniu końcowego, równego ustawienia urządzenia holowniczego.
3. Zgodnie z typem pojazdu wykonujemy wycięcie w zderzaku. Montujemy ponownie wszystkie części zdemontowane w punkcie nr 1."

FR Notice de montage

Pour des instructions d'installation détaillées et les conditions du produit, scannez le code QR

1. Déposer les feux arrières, le pare-chocs et son renfort en acier (ce dernier ne sera plus nécessaire).
2. À l'aide de vis M12 (BMW) existants, monter, sur des rondelles de grande surface, le longeron principal du dispositif d'attelage à la place du renfort en acier. Serrer aux couples préconisés. S'assurer que le dispositif d'attelage soit égalisé.
3. Faire une découpe dans le pare-chocs en fonction du type de véhicules. Reposer toutes les pièces déposées à la section n°1.

FI Asennusohje

Tarkemmat asennusohjeet ja tuotteen ehdot on tarkistettava QR-koodilla

1. Irrota takavalot, puskuri ja sen teräsjäykiste (sitä ei enää tarvita).
2. Asenna teräsjäykisteeseen paikalle vetolaitteen pääpalkki entisillä muttereilla M12 (BMW) suuria aluslevyjä käyttäen. Kiristä kiristysmomenttien mukaisesti. Varmista, että vetolaitte tulee suoraan.
3. Tee puskuriin leikkaus auton tyyppin mukaan. Asenna takaisin kaikki kohdassa 1. irrotetut osat.



QR k

SVC GROUP s.r.o.

Průmyslová zóna - 179
547 01 Náchod-ČR

www.svcgroup.cz

e-mail: svc@svcgroup.cz

tructions

Tel.: +420 491 421 021
+420 491 421 022
mob.: +420 603 360 607

SVC GROUP ©- 05/19

1.

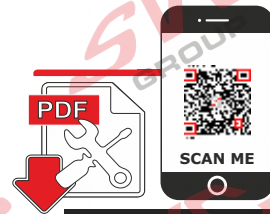
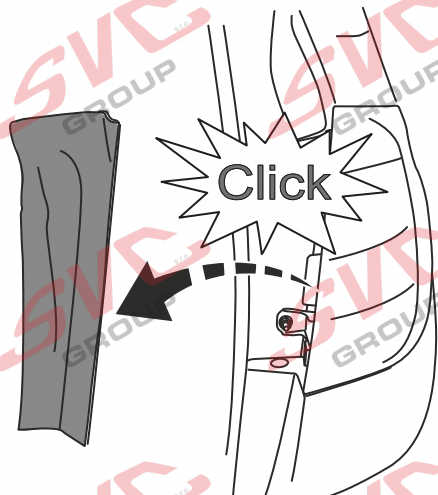
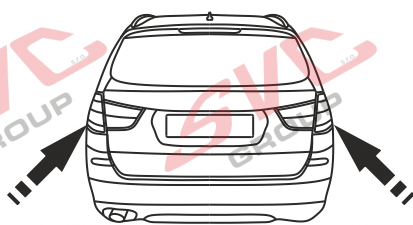

Montážní návod
 Montážny návod
 Installation instructions
 Installationsanleitung
 Instructions d'installation
 Инструкция по установке

2.

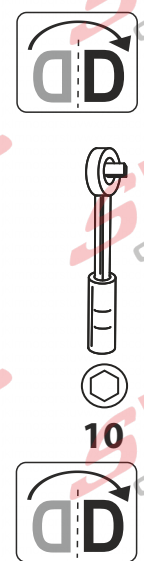
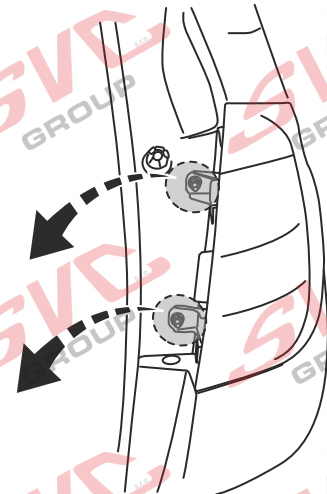
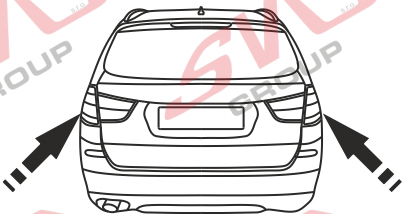

3.

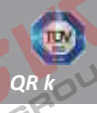
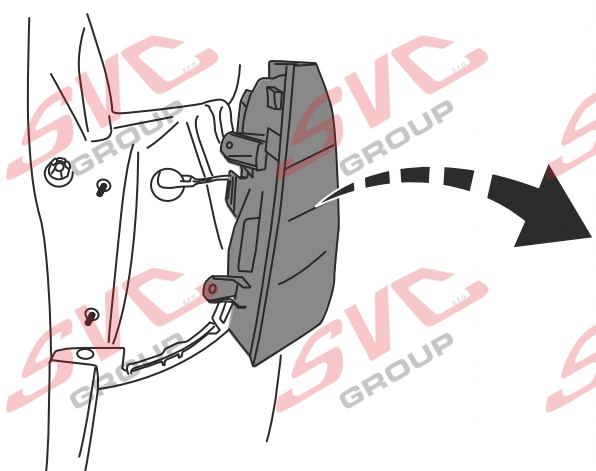
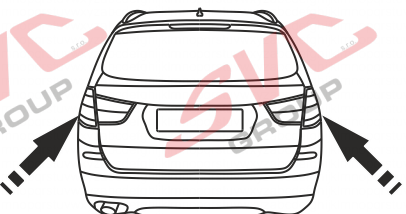

4.

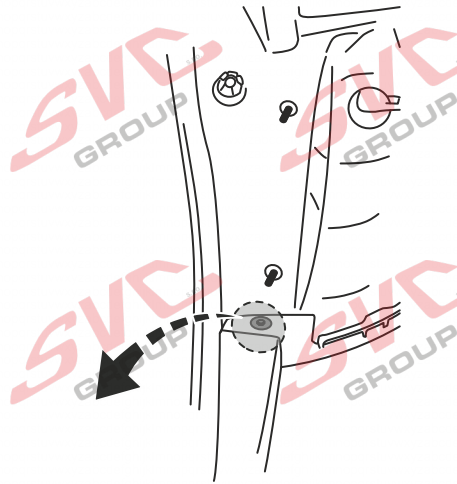

5.

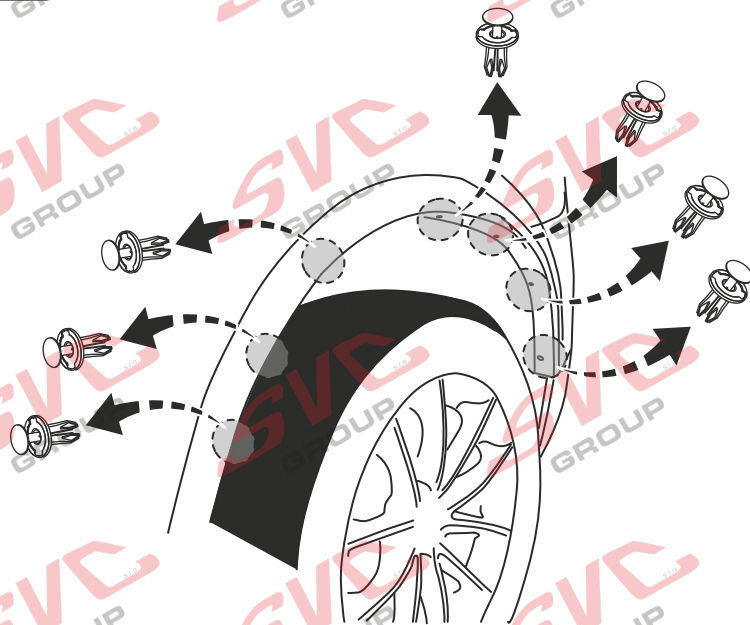
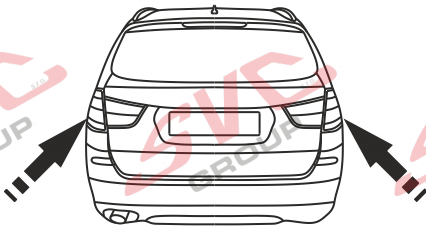

6.

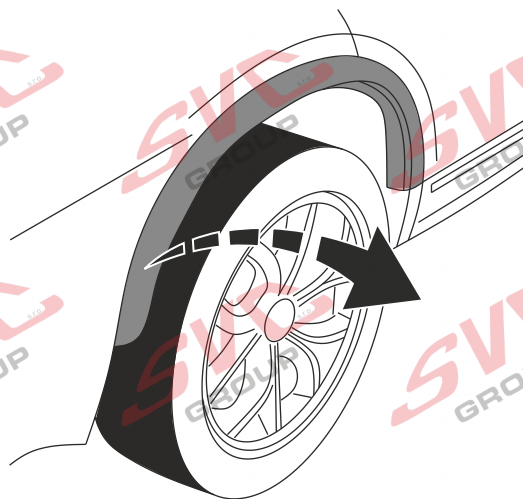
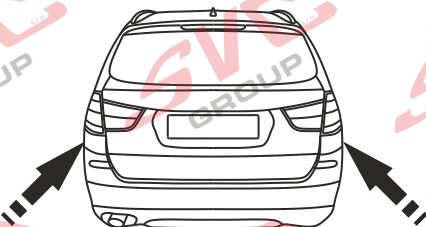

7.

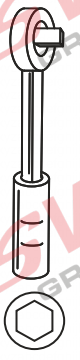
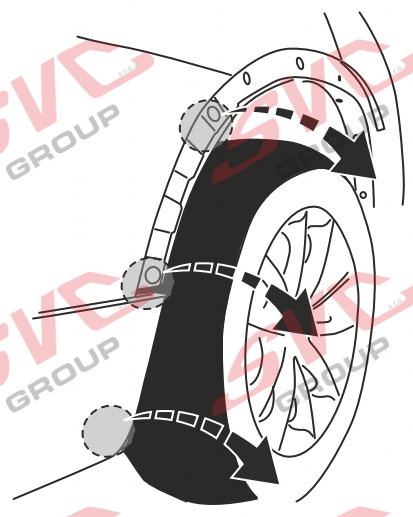
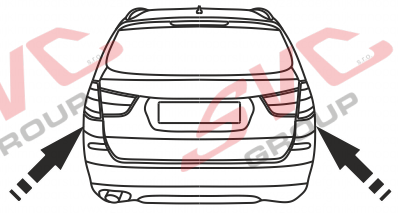

8

8.

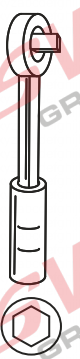
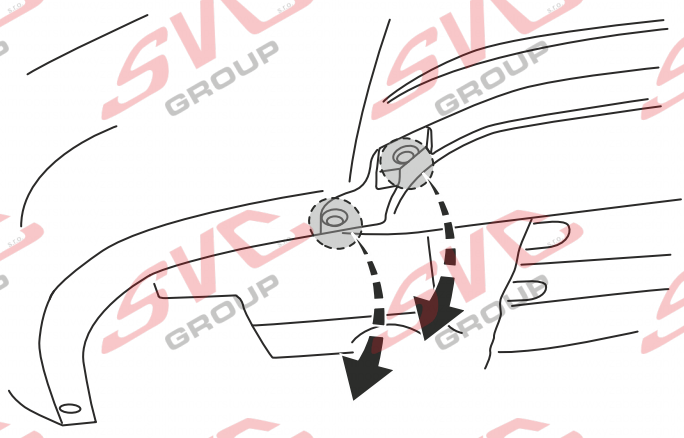
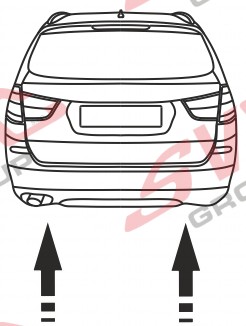

8

9.

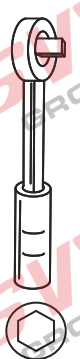
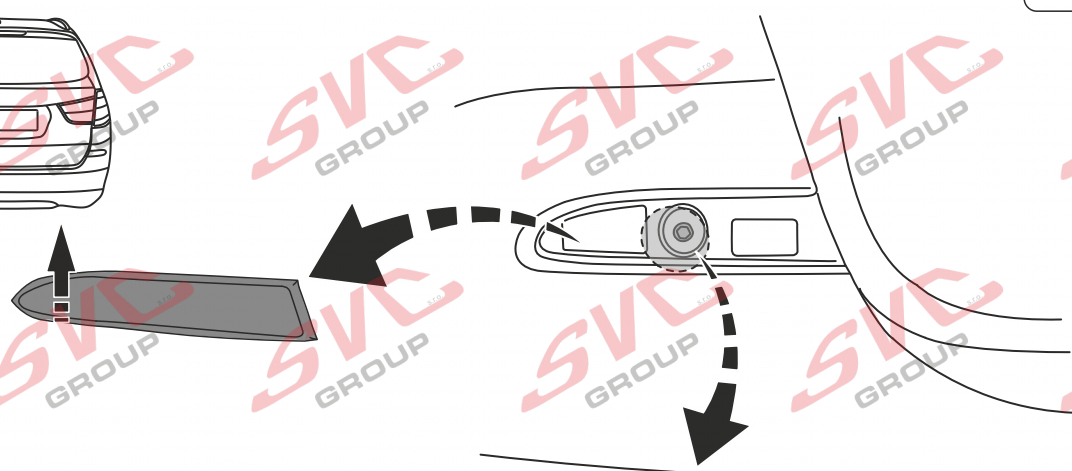
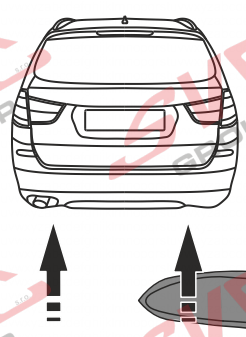

8



10.

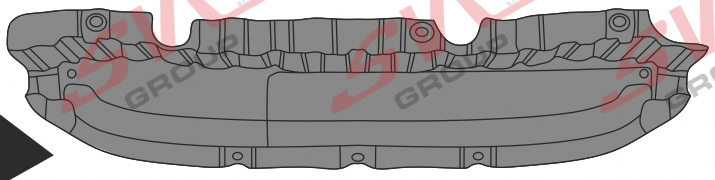
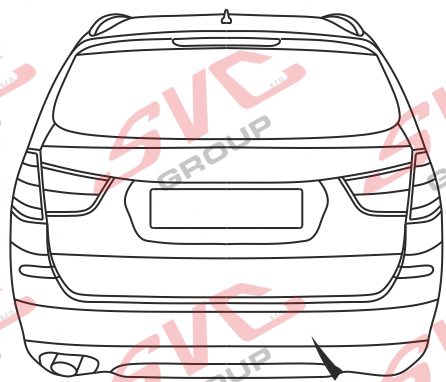

11.

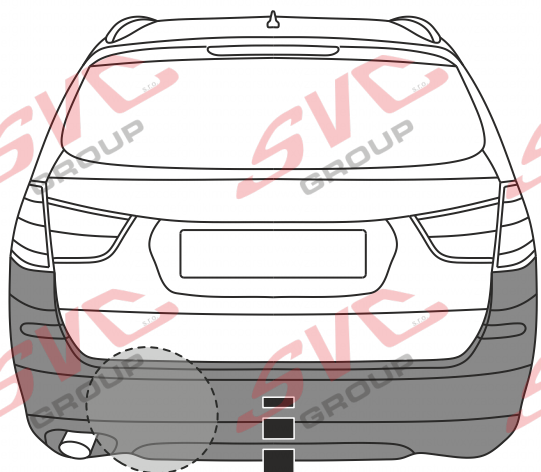

12.

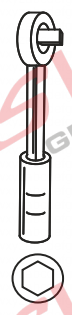
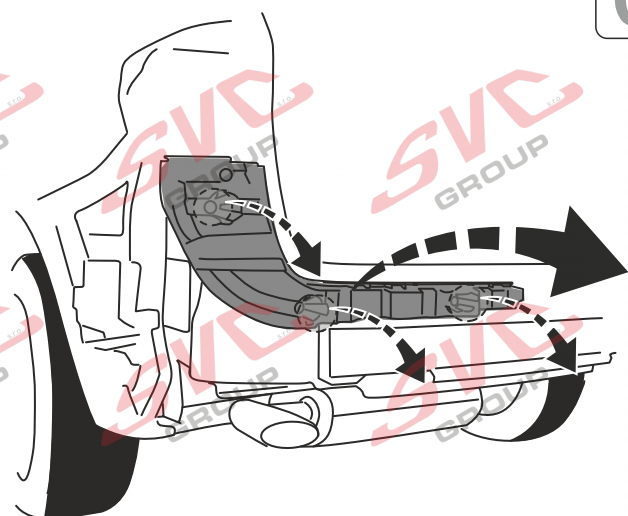
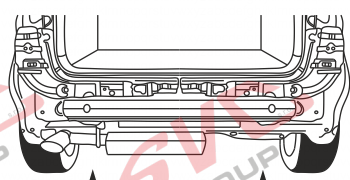

10

BMW x3



QR k

13.

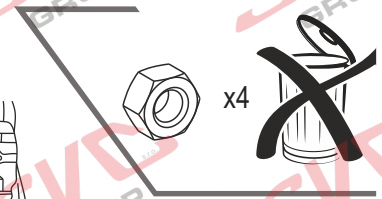
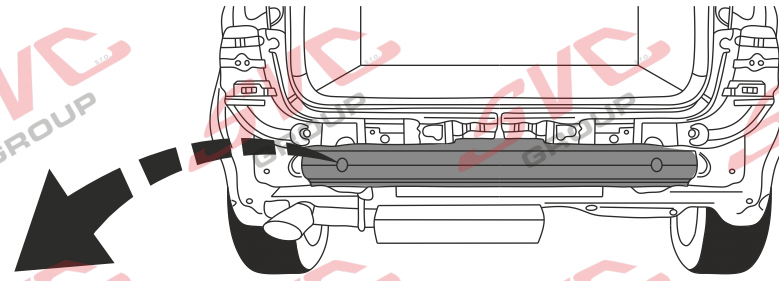

x4

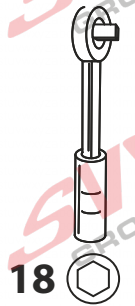

18

14.

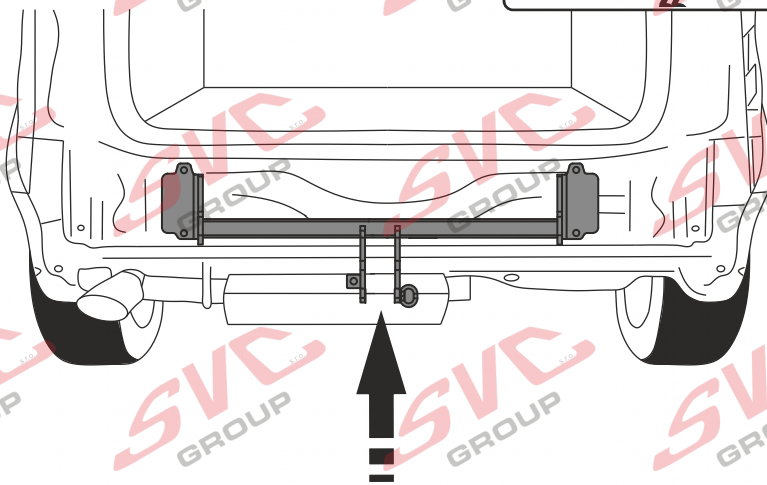
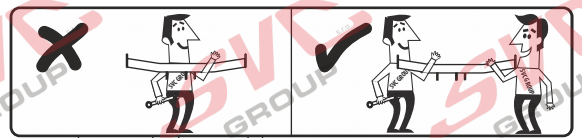

15.

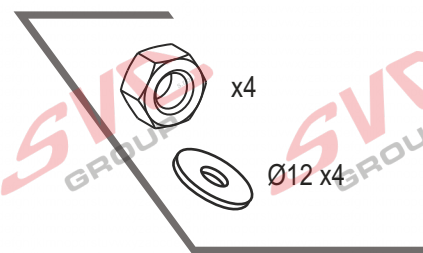

x4

Ø12 x4

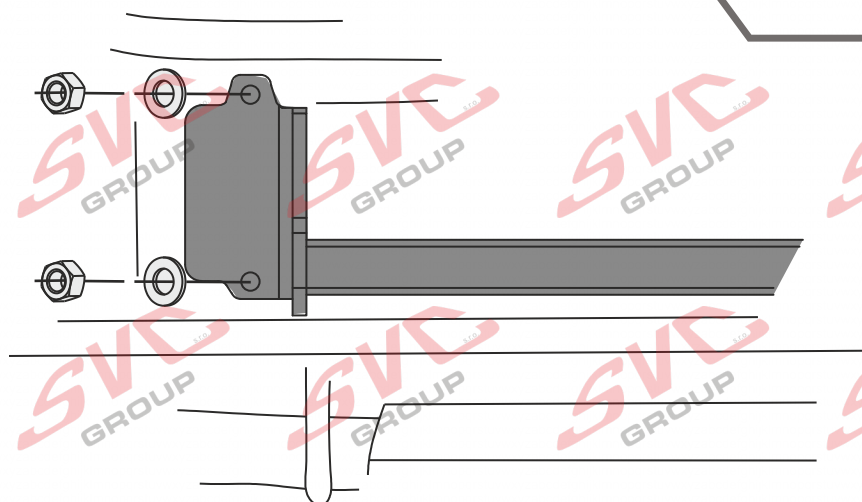
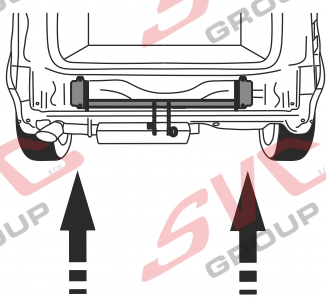

18





16.

Plart pod nárazníkem

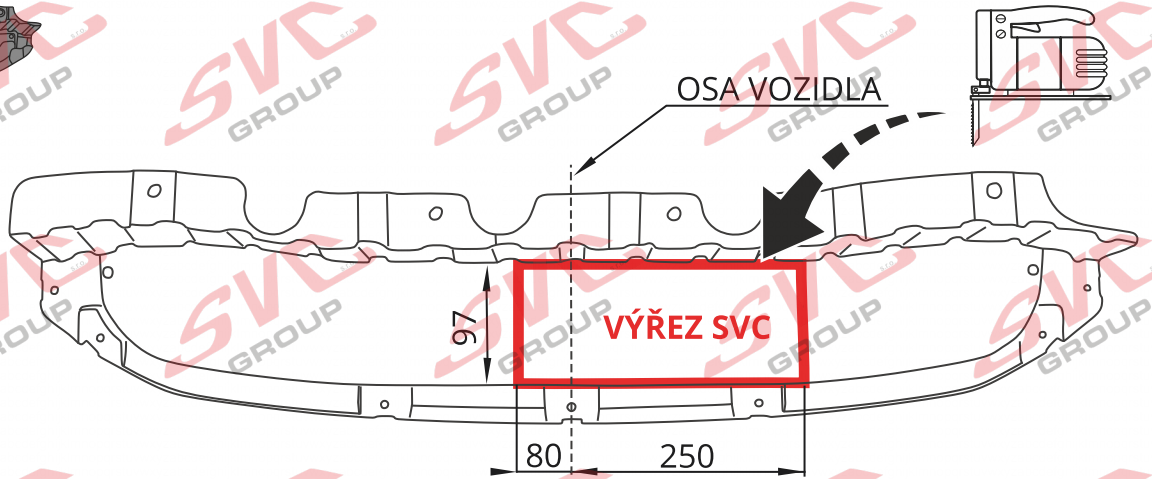
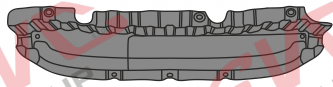

17.

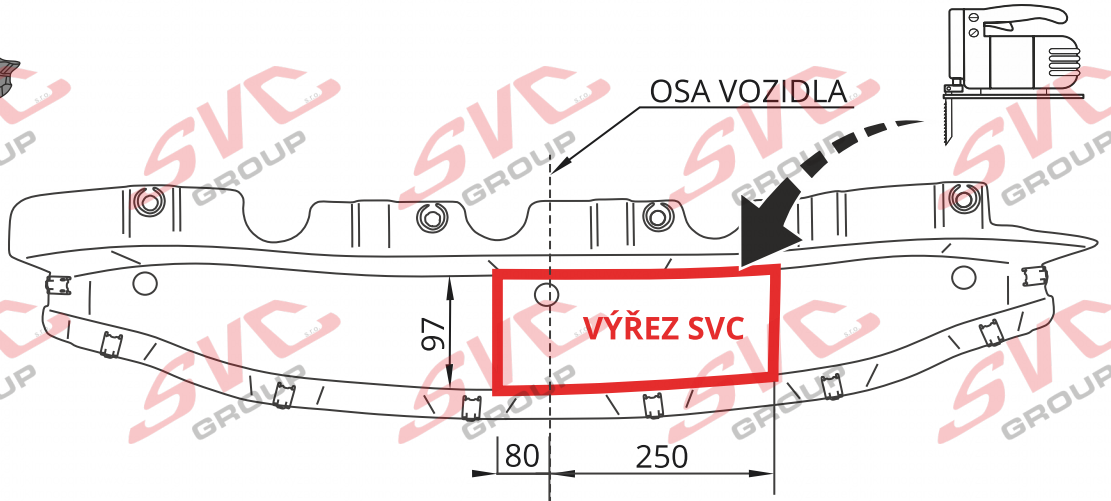
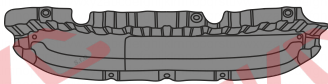

18.

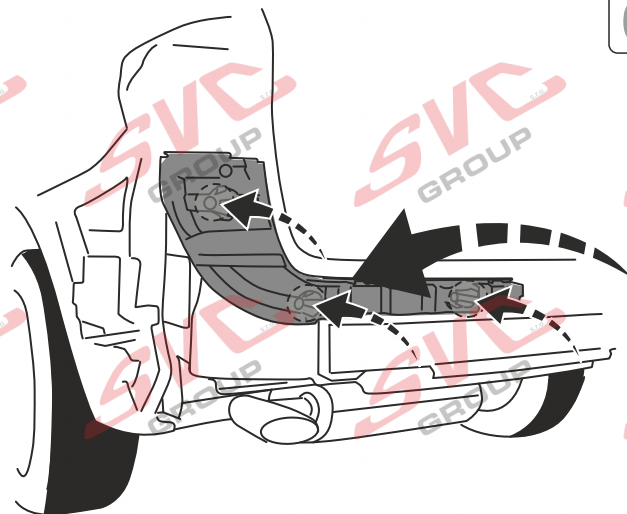
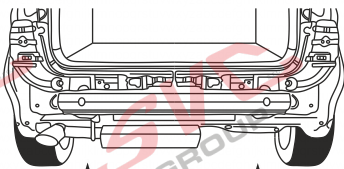

BMW x3





19.

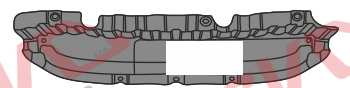
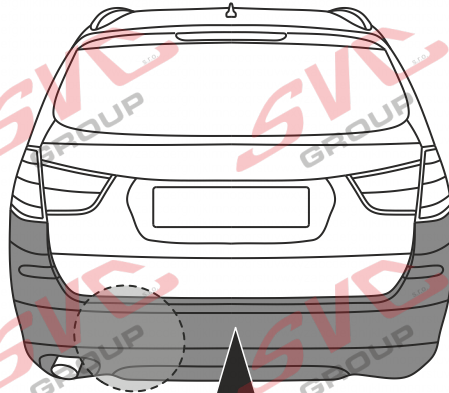

21.

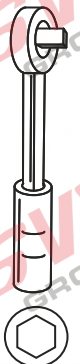
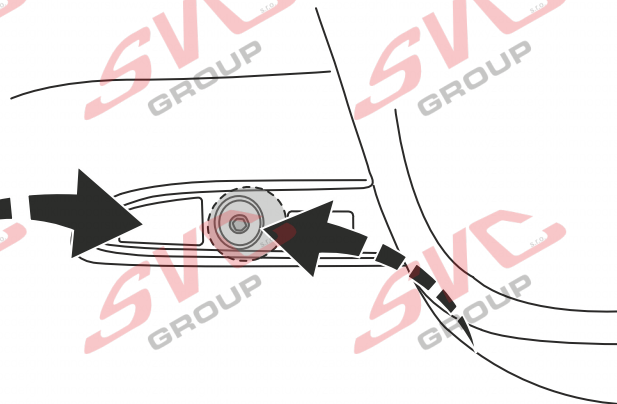
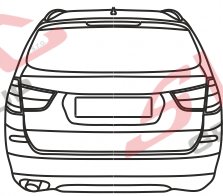

8



22.

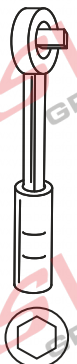
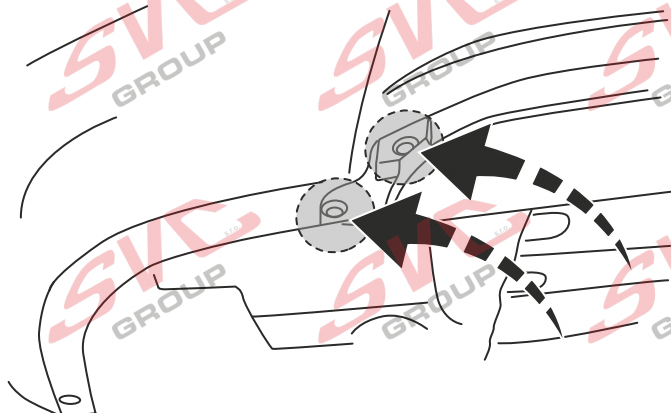
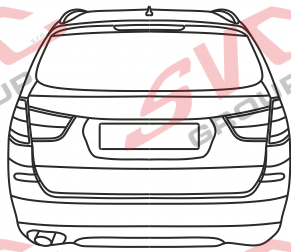

8



23.

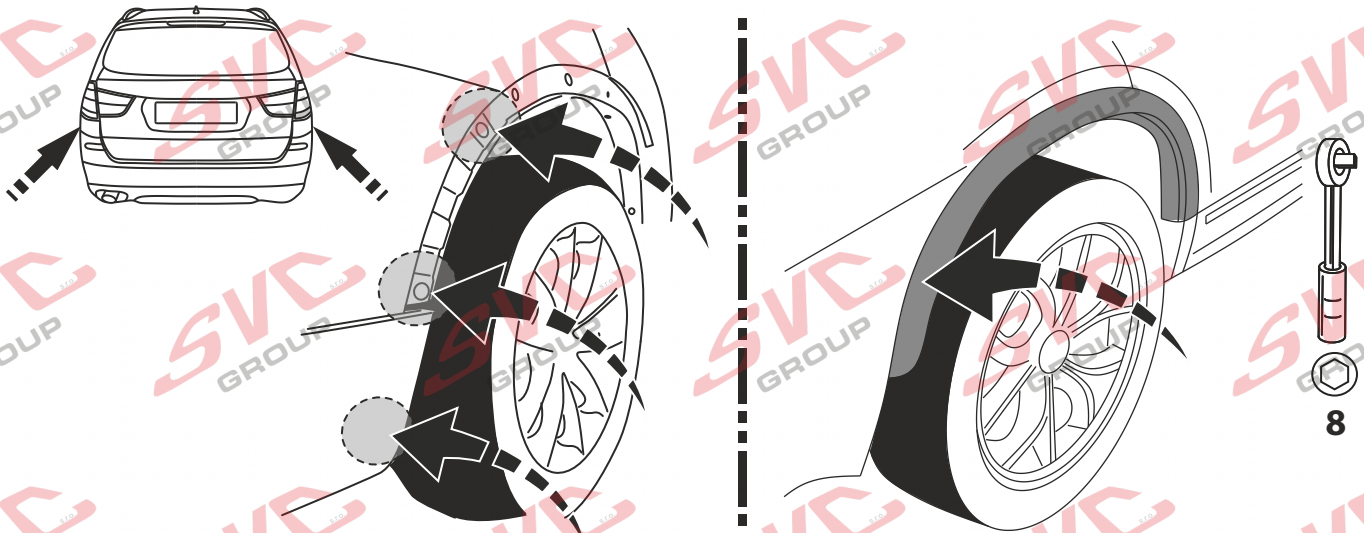

24.

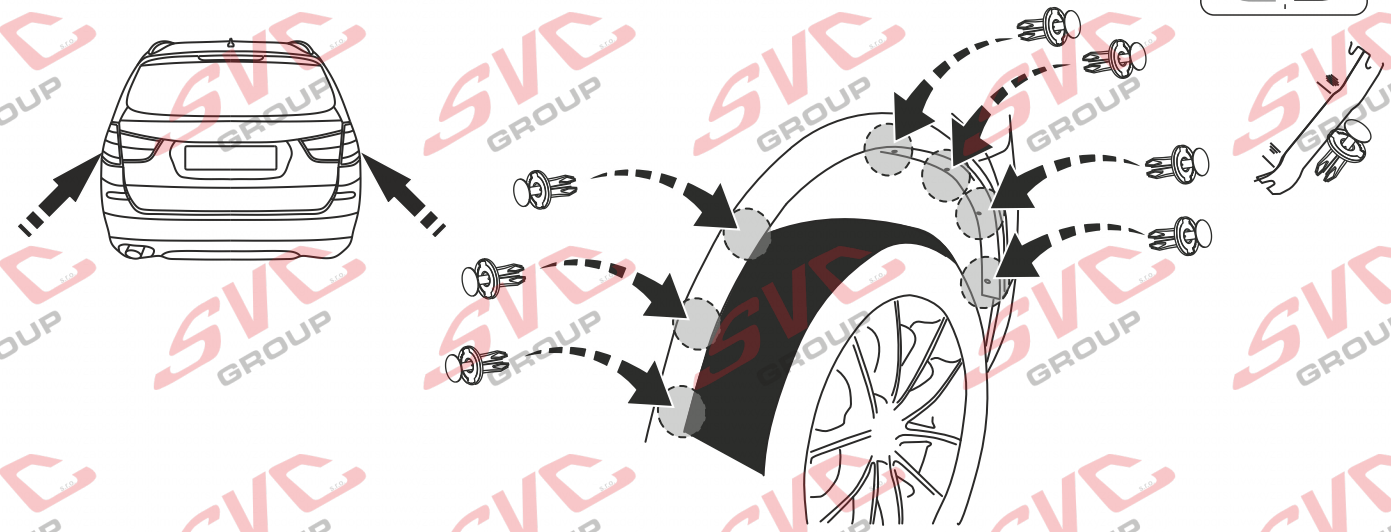

25.

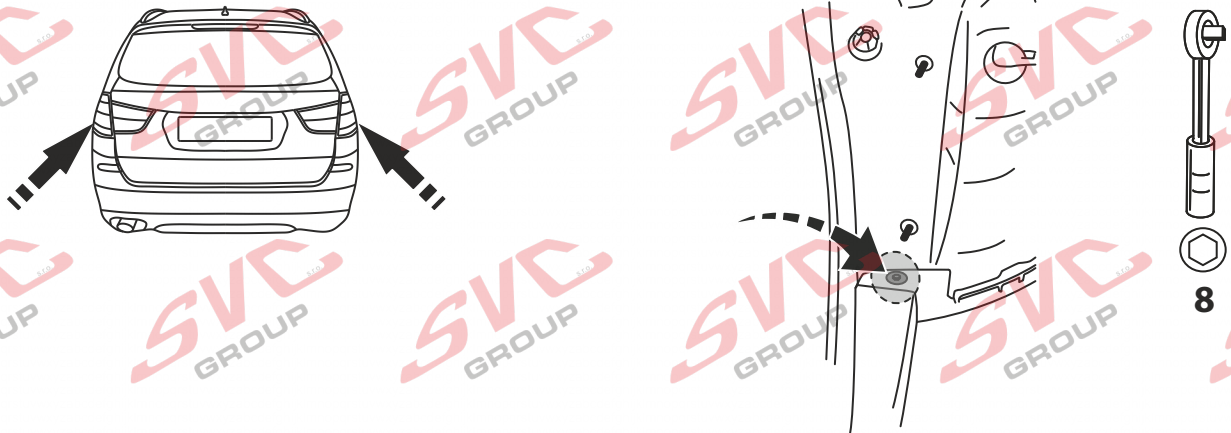

 **26.**

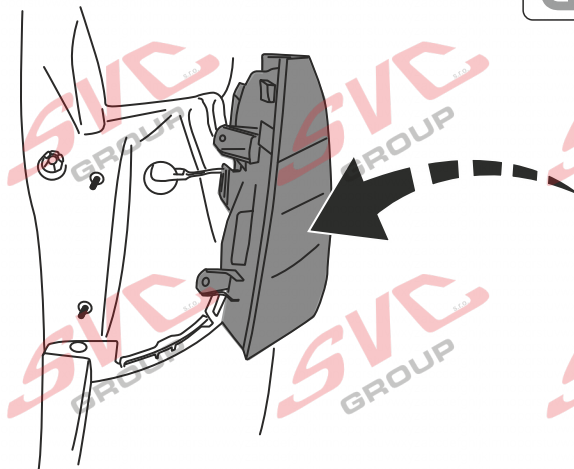
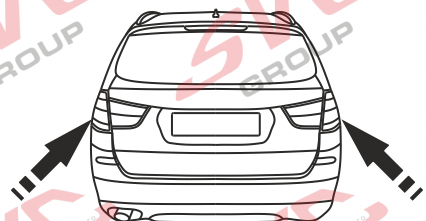

 **27.**

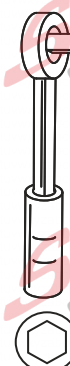
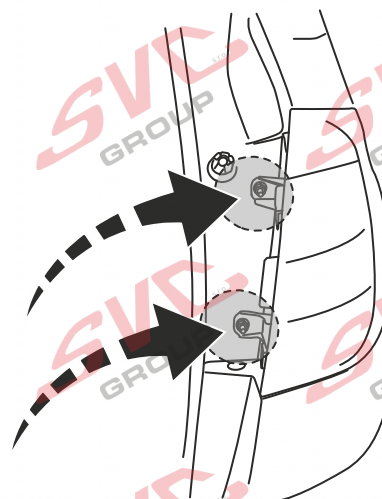
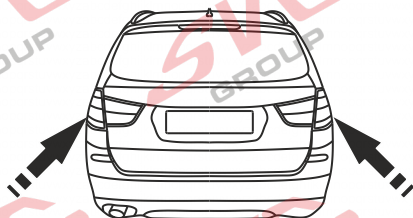

10

 **28.**

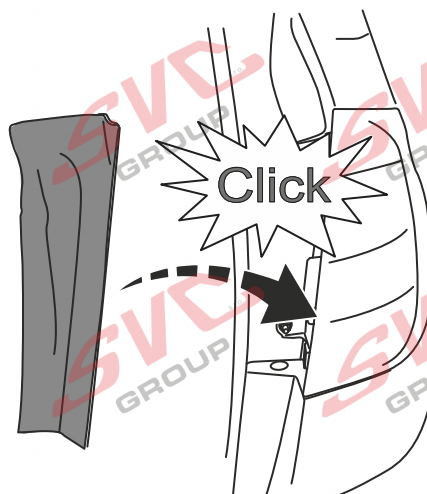
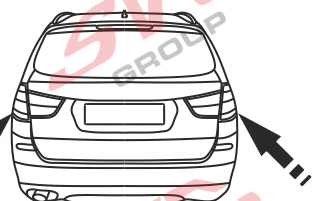

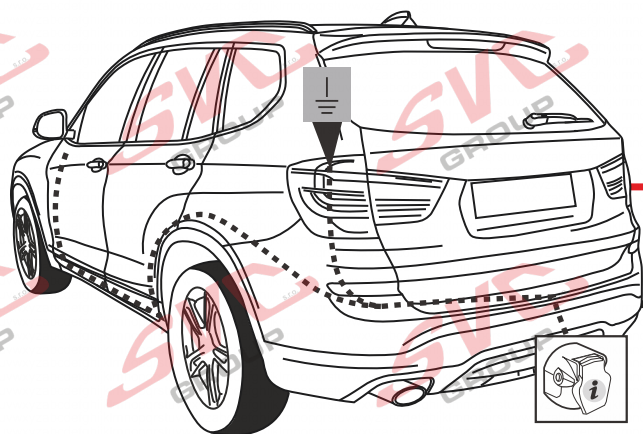

BMW x3

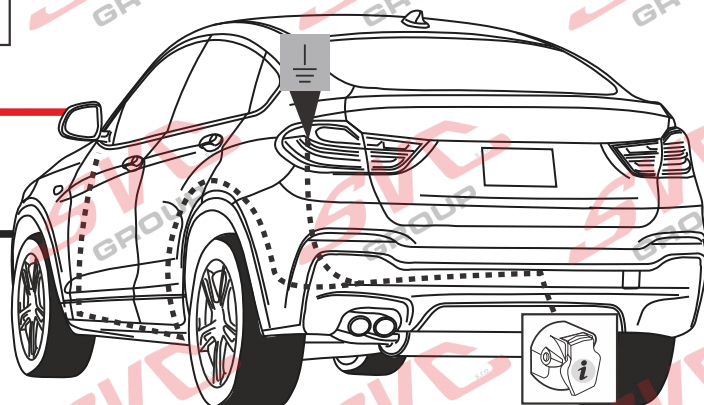

BMW x4

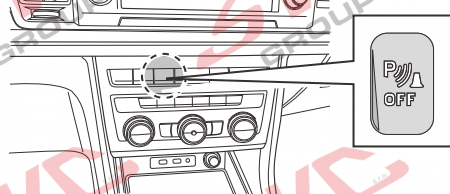

Informace pro odpojování couvacích senzorů PDC pro tažné zařízení

Vypínač pro vypínání couvacích senzorů PDC je umístěn na palubní desce vozu.

Nemusíte tedy pracně na elektro instalaci vozu napojovat odpojování couvacích senzorů PDC a zpětných kamer od elektro přípojky tažných zařízení.

Pokud chcete senzory vypnout, použijte vypínač na palubní desce.

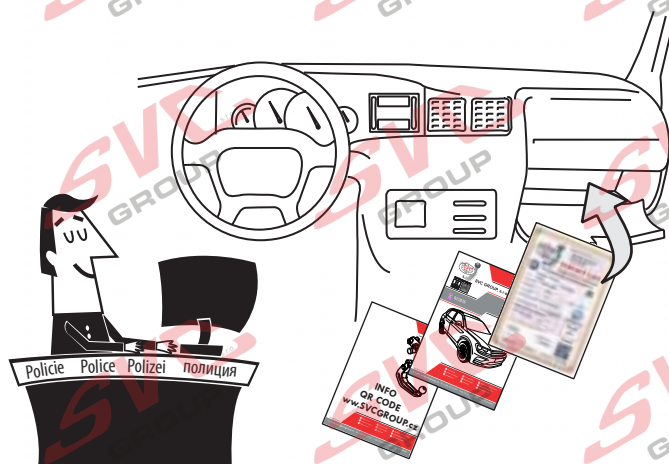
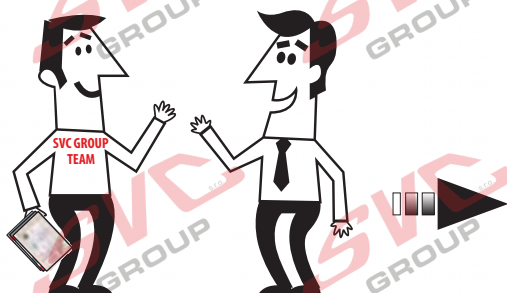

SVC GROUP

Děkuje za důvěru / Ďakuje za dôveru

Thank you for your trust / Danke Für dein Vertrauen

Merci pour votre conance / Grazie per la tua ducia

Tankewol foar jo fertrouwen / Спасибо за ваше доверие

Registrace / Registrácia

Registration / Registrierung

Inscription / Registrazione

Rekisteröinti / Регистрация





BMW x3 F25
BMW x3 G01
BMW x4 F26



2010 -> 10/2017
1/2017 ->
2010 -> 10/2018

N-1

ES Manual de montaje

Para obtener instrucciones detalladas de instalación y condiciones del producto, escanee el código QR

1. Desmonte los focos traseros, parachoques y su refuerzo de acero (no hará falta más).
2. En el puesto del refuerzo de acero instale el soporte principal del equipo de tiro por medio de las tuercas existentes M12(BMW) a través de arandelas grandes. Apriete según los pares de apriete. Enderece bien el equipo de tiro.
3. Haga el recorte del parachoques según el tipo del vehículo. Monte de vuelta todas las piezas desmontadas según el punto No. 1.

IT Istruzioni di montaggio per la

Per istruzioni di installazione dettagliate e condizioni del prodotto, eseguire la scansione del codice

1. Smontare i fanali posteriori, il paraurti e il suo rinforzo di acciaio (non sarà più necessario).
2. In luogo del rinforzo di acciaio montare il supporto principale del dispositivo di traino usando i dadi esistenti M12 (BMW) e rondelle di grande dimensione. Serrare con le coppie di serraggio prescritte. Far attenzione all'allineamento del dispositivo di traino.
3. Secondo il tipo del veicolo fare un intaglio nel paraurti. Rimontare tutti i componenti smontati nel punto 1.

NO Monteringsanvisning

For installasjonsinstruksjoner og produktbetingelser, skann QR-koden

1. Demontér baklys, støtfanger og dens forsterkning av stål (den vil ikke lenger trenges).
2. Montér på stedet etter forsterkningen av stål trekkutstyrets hovedbæreelement og det ved hjelp av de eksisterende mutterne av typen M12(BMW) via underlagene med store ater. Stram i samsvar med de foreskrevde tiltrekkingmomentene. Vær nøye med balansering av trekkutstyret.
3. Lag en støtfangerutskjæring alt etter hvilken biltype det er snakk om. Montér på plass igjen alle de delene som ble demontert i punkt nr. 1.

NL Montagehandleiding

Scan de QR-code voor installatie-instructies en instructies voor productcondities

1. Verwijder de achterlichten, bumper en de stalen versterkingsdeel (deze is niet langer nodig).
2. Zet in plaats van de vorige versterker de hoofdligger van de trekhaak met behulp van M12 moeren (BMW) vast onder toepassing van extra grote ringen. Lijn de trekhaak uit en schroef deze overeenkomstig de aanbevolen aanhaalmomenten aan.
3. Maak een uitsparing in de bumper, afhankelijk van het model van de auto. Plaats alle volgens punt 1 verwijderde onderdelen terug.

HU Szerelési útmutató

A telepítési és a termékfeltételekkel kapcsolatos utasításokat olvassa be a QR-kódot

1. Távolítsa el a hátsó lámpákat, a lökhárítót és a acél tartót (erre már nem lesz szüksége).
2. A fém tartó helyére szerelje fel a vonóhorog fő hordozóját a meglévő M12(BMW) anyák segítségével a nagy felületű alátéteken át. Húzza meg a meghúzási nyomatékok szerint. Ügyeljen a vonóhorog egyensúlyozására.
3. Vágja ki jármű típus szerint a lökhárító részét. Helyezze vissza az 1. lépésben eltávolított alkatrészeket.

RU Инструкция по монтажу

Подробные инструкции по установке и условиям продукта отсканируйте QR-к

1. Снимите задние фонари, бампер и его стальной усилитель (он больше не потребуется.).
2. На месте бывшего усилителя закрепите главную балку фаркопа с помощью гаек М12 (BMW) с использованием увеличенных шайб. Выровняйте фаркоп и затяните в соответствии с предписанными моментами затяжки.
3. Сделайте в бампере вырез в зависимости от модели автомобиля. Верните на место все части, демонтированные согласно пункту 1.



SVC GROUP s.r.o.

Průmyslová zóna - 179
547 01 Náchod-ČR

www.svcgroup.cz
e-mail: svc@svcgroup.cz

Tel.: +420 491 421 021
+420 491 421 022
mob.: +420 603 360 607

SVC GROUP ©- 05/19

QR kódem stáhnete rozšířený montážní návod / Verwenden Sie den QR-Code, um die erweiterte Montageanleitung herunterzuladen



T-1

CZ Informace k provozu / homologaci

Výrobek je vyráběn dle platných norem EHK-55 R pro prodej ve státech EU. Informace pro použití, provoz a záruky pro tažné zařízení naleznete na našem webu, www.svcgroup.cz

Technické informace > Tažné zařízení > Všeobecné podmínky použití výrobku. Nebo si je stáhněte aplikace přes přiložený QR-cod

Součástí dodávky tažného zařízení je dodán TYPOVÝ LIST. Tento typový list slouží pro zapsání výrobku do technického průkazu vozidla, a obsahuje základní podmínky pro použití výrobku.

Typový list slouží i jako záruční lis proto jej uschovejte v dokumentaci vozidla.

SK Informácie na prevádzku / homologáciu

Výrobok je vyrábaný podľa platných noriem EHK-55 R pre predaj v štátoch EÚ. Informácie pre použitie, prevádzku a záruky pre ťažné zariadenie nájdete na našom webe, www.svcgroup.cz

Technické informácie > Ťažné zariadenie > Všeobecné podmienky použitia výrobku. Alebo si ich stiahnite aplikácie cez priložený QR-cod

Súčasťou dodávky ťažného zariadenia je dodaný TYPOVÝ LIST. Tento typový list slúži pre zapísanie výrobku do technického preukazu vozidla, a obsahuje základné podmienky použitia výrobku.

Typový list slúži aj ako záručný lis preto ho uschovajte v dokumentácii vozidla.

EN Operating / homologation information

The product is manufactured according to the applicable EHK-55 R standards for sale in EU countries. Information on the use, operation and warranties for the towbar can be found on our website, www.svcgroup.com

Technical information > Towing hitch > General conditions of use. Or download them via QR-cod

The towing device is supplied with a TYPE SHEET. This data sheet is used to enter the product in the vehicle registration document and contains the basic conditions for use of the product.

The data sheet also serves as a warranty press, so keep it in the vehicle documentation.

DE Betriebs / Zulassungsinformationen

Das Produkt wird gemäß den geltenden EHK-55 R-Standards für den Verkauf in EU-Ländern hergestellt. Informationen zu Verwendung, Betrieb und Gewährleistung der Anhängerkupplung finden Sie auf unserer Website www.svcgroup.com

Technische Informationen > Anhängerkupplung > Allgemeine Nutzungsbedingungen. Oder laden Sie sie per QR-Code herunter

Die Anhängervorrichtung wird mit einem TYPENBLATT geliefert. Dieses Datenblatt dient zur Eintragung des Produkts in das Kfz-Kennzeichen und enthält die Grundbedingungen für die Verwendung des Produkts. Das Datenblatt dient auch als Garantiepresse. Bewahren Sie es daher in der Fahrzeugdokumentation auf.

HU Üzemeltetési / homologációs információk

Das Produkt wird gemäß den geltenden EHK-55 R-Standards für den Verkauf in EU-Ländern hergestellt. Informationen zu Verwendung, Betrieb und Gewährleistung der Anhängerkupplung finden Sie auf unserer Website www.svcgroup.com

Technische Informationen > Anhängerkupplung > Allgemeine Nutzungsbedingungen. Oder laden Sie sie per QR-Code herunter

Die Anhängervorrichtung wird mit einem TYPENBLATT geliefert. Dieses Datenblatt dient zur Eintragung des Produkts in das Kfz-Kennzeichen und enthält die Grundbedingungen für die Verwendung des Produkts. Das Datenblatt dient auch als Garantiepresse. Bewahren Sie es daher in der Fahrzeugdokumentation auf.

FR Informations d'exploitation / homologation

Le produit est fabriqué conformément aux normes EHK-55 R applicables pour la vente dans les pays de l'UE. Des informations sur l'utilisation, le fonctionnement et les garanties de l'attelage sont disponibles sur notre site Web, www.svcgroup.com.

Informations techniques > Attelage de remorquage > Conditions générales d'utilisation. Ou téléchargez-les via QR-cod

Le dispositif de remorquage est fourni avec une feuille de type. Cette fiche technique est utilisée pour entrer le produit dans le certificat d'immatriculation du véhicule et contient les conditions de base pour l'utilisation du produit. La fiche technique sert également de presse de garantie, conservez-la dans la documentation du véhicule.

IT Informazioni sull'operazione / omologazione

Il prodotto è fabbricato secondo le norme EHK-55 R applicabili in vendita nei paesi dell'UE. Informazioni sull'uso, il funzionamento e le garanzie per il gancio di traino sono disponibili sul nostro sito Web www.svcgroup.com

Informazioni tecniche > Gancio di traino > Condizioni generali d'uso. Oppure scaricali tramite QR-cod

Il dispositivo di rimorchio viene fornito con una SCHEDA TIPO. Questa scheda tecnica viene utilizzata per inserire il prodotto nel certificato di immatricolazione del veicolo e contiene le condizioni di base per l'uso del prodotto. La scheda tecnica funge anche da stampa di garanzia, quindi conservala nella documentazione del veicolo.



SVC GROUP s.r.o. Průmyslová zóna - 179 www.svcgroup.cz

547 01 Náchod-ČR

e-mail: svc@svcgroup.cz

Tel.: +420 491 421 021

+420 491 421 022

mob.: +420 603 360 607

SVC GROUP © - 05/19

QR kódem stáhněte rozšířený montážní návod / QR-kóddal letöltheti a kibővített összeszerelési utasításokat



T-2

NL Monteringsanvisningar

Het product is vervaardigd volgens de toepasselijke EHK-55 R-normen voor verkoop in EU-landen. Informatie over het gebruik, de werking en de garanties voor de trekhaak vindt u op onze website, www.svcgroup.com *Technische informatie* > *Trekhaak* > *Algemene gebruiksvoorwaarden*. Of download ze via QR-cod
Het sleepapparaat wordt geleverd met een TYPE BLAD. Dit gegevensblad wordt gebruikt om het product in het voertuigregistratiedocument in te voeren en bevat de basisvoorwaarden voor het gebruik van het product. Het gegevensblad dient ook als garantiepers, dus bewaar het in de voertuigdocumentatie.

ES Instrucciones de montaje

El producto se fabrica de acuerdo con los estándares EHK-55 R aplicables para la venta en países de la UE. Puede encontrar información sobre el uso, el funcionamiento y las garantías de la barra de remolque en nuestro sitio web, www.svcgroup.com *Información técnica* > *Enganche de remolque* > *Condiciones generales de uso*. O descárguelos a través de QR-cod
El dispositivo de remolque se suministra con una HOJA DE TIPO. Esta hoja de datos se utiliza para ingresar el producto en el documento de registro del vehículo y contiene las condiciones básicas para el uso del producto. La hoja de datos también sirve como una prensa de garantía, por lo tanto, consérvela en la documentación del vehículo.

FIN Montage-instructie

Tuote on valmistettu EU-maissa myytävien EHK-55 R -standardien mukaisesti. Tietoja vetokoukun käytöstä, käytöstä ja takuista löytyy verkkosivuiltamme www.svcgroup.com *Tekniset tiedot* > *Vetokoukku* > *Yleiset käyttöolosuhteet*. Tai lataa ne QR-koodin kautta
Hinauslaite toimitetaan TYYPPI-ARKKI. Tätä lomaketta käytetään tuotteen syöttämiseen ajoneuvon rekisteröintitodistukseen, ja se sisältää tuotteen käytön perusedellytykset. Tietolomake toimii myös takuupuristimena, joten säilytä se ajoneuvon dokumenteissa.

SL

Izdelek je izdelan po veljavnih standardih EHK-55 R za prodajo v državah EU. Informacije o uporabi, delovanju in garancijah za vlečno ploščo najdete na našem spletnem mestu www.svcgroup.com *Tehnični podatki* > *Vlečna kljuka* > *Splošni pogoji uporabe*. Ali pa jih prenesite preko QR-kod
Vlečna naprava je opremljena s TIPNIM LISTOM. Ta podatkovni list se uporablja za vnos izdelka v registracijski dokument vozila in vsebuje osnovne pogoje za uporabo izdelka. Podatkovni list služi tudi kot garancijski tisk, zato ga hranite v dokumentaciji vozila.

NOR Drifts- / homologasjonsinformasjon

Produktet er produsert i henhold til gjeldende EHK-55 R standarder for salg i EU-land. Informasjon om bruk, drift og garantier for tilhengerfeste finner du på vår hjemmeside, www.svcgroup.com *Teknisk informasjon* > *Tilhengerfeste* > *Generelle bruksbetingelser*. Eller last dem ned via QR-koding
Tøaeanordningen leveres med TYPEBLAD. Dette databladet brukes til å oppgi produktet i kjøretøyets registreringsbevis og inneholder de grunnleggende betingelsene for bruk av produktet. Databladet fungerer også som garantipresse, så hold det i bilens dokumentasjon.

PL Informacje dotyczące pracy / homologacji

Produkt jest wytwarzany zgodnie z obowiązującymi normami EHK-55 R na sprzedaż w krajach UE. Informacje na temat użytkowania, obsługi i gwarancji na hak holowniczy można znaleźć na naszej stronie internetowej www.svcgroup.com *Informacje techniczne* > *Żaczep holowniczy* > *Ogólne warunki użytkowania*. Lub pobierz je za pomocą kodu QR
Urządzenie holownicze jest dostarczane z ARKUSZEM TYPU. Ta karta danych służy do wpisania produktu do dokumentu rejestracyjnego pojazdu i zawiera podstawowe warunki użytkowania produktu. Karta danych służy również jako prasa gwarancyjna, dlatego przechowuj ją w dokumentacji pojazdu.

RU Информация о работе / омологации

El producto se fabrica de acuerdo con los estándares EHK-55 R aplicables para la venta en países de la UE. Puede encontrar información sobre el uso, el funcionamiento y las garantías de la barra de remolque en nuestro sitio web, www.svcgroup.com *Información técnica* > *Enganche de remolque* > *Condiciones generales de uso*. O descárguelos a través de QR-cod
El dispositivo de remolque se suministra con una HOJA DE TIPO. Esta hoja de datos se utiliza para ingresar el producto en el documento de registro del vehículo y contiene las condiciones básicas para el uso del producto. La hoja de datos también sirve como una prensa de garantía, por lo tanto, consérvela en la documentación del vehículo.



SVC GROUP s.r.o. Průmyslová zóna - 179 547 01 Náchod-ČR

www.svcgroup.cz
e-mail: svc@svcgroup.cz

Tel.: +420 491 421 021
+420 491 421 022
mob.: +420 603 360 607
SVC GROUP © - 05/19

QR kódem stáhnete rozšířený montážní návod / Con il codice QR è possibile scaricare le istruzioni di assemblaggio estese



PODMÍNKY HOMOLOGACE

E-1

Montážní instrukce - Montažny inštrukcia - Installation insrtruktion - Montageanleitung - Istruzioni di montaggio - Instrukcja montażu - Manual de montaje Monteringsvejledning - Paigaldusjuhend - Asennusohje - Notice de montage - Sz. szerelési útmutató - Montagehandleiding - Monteringsanvisning - Instruções de montaj - Teringsanvisningar - Инструкции по монтажу

- CZ** Volný prostor dle přílohy VII, směrnice č. EC 55-R EU musí být dodržen.
- SK** Volný priestor podľa prílohy VII, smernice č. EC 55-R EÚ musí byť dodržaný.
- EN** The clearance specified in appendix VII, diagram 25 of guideline EC 55-R EU must be guaranteed.
- DE** Der Freiraum nach Anhang VII, Abbildung 25 der Richtlinie EC 55-R EU ist zu gewährleisten.
- HU** Az EC 55-R EU irányelv VII. mellékletében, a 25. ábrán a vonógömb elhelyezése számára elírt szabad tér-adatokat biztosítani kell.
- FR** La zone de dégagement doit être conforme à l'annexe VII, illustration 25 de la directive EC 55-R EU.
- IT** Deve essere garantito lo spazio libero secondo l'allegato VII, gura 25 della direttiva EC 55-R EU.
- NL** De tussenruimte conform supplement VII, afbeelding 25 van de richtlijn EC 55-R moet in acht worden genomen.
- ES** Debe garantizarse el espacio libre, conforme al anexo VII, gura 25 de la directiva comunitaria EC 55-R EU.
- FIN** Vapaa tila on taattava direktiivin EC 55-R EU liitteessä VII, kuvan 25 mukaisesti.
- SV** Spelrummet enligt bilaga VII, Figur 25 i riktlinje EC 55-R EU skall garanteras.
- NOR** Frirommet etter tillegg VII, gur 25 i direktiv EC 55-R EU skal overholdes.
- PL** Należy zapewnić szczelność zgodnie z rysunkiem nr 25 dyrektywy EC 55-R zawartej w załączniku nr VII.
- RU** Шарика в приложении VII. Директивы EC 55-R eu.

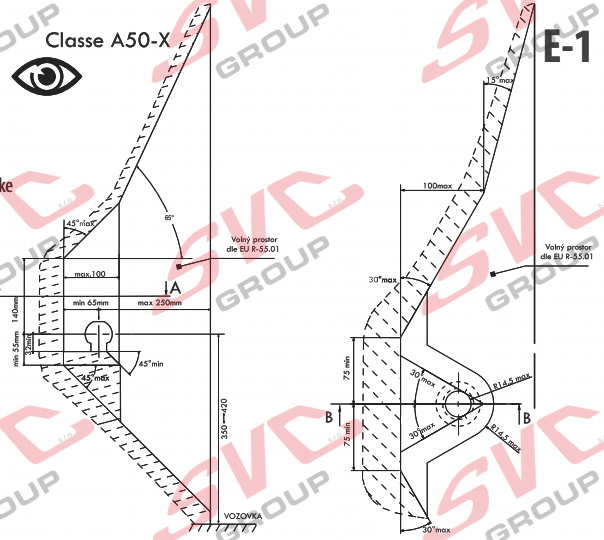

- CZ** Při celkové přípustné hmotnosti vozidla
- SK** Pri celkovej prípustnej hmotnosti vozidla
- EN** At laden weight of the vehicle
- DE** Bei zulässigem Gesamtgewicht des Fahrzeuges
- HU** Rakományal terhelt járművel esztén
- FR** Pour poids total en charge autorisé du véhicule
- IT** Per un peso complessivo ammesso del veicolo
- NL** Bij toelaatbaar totaal gewicht van het voertuig
- ES** Con peso total autorizado del vehículo
- FIN** Ajoneuvon suurimmalla sallitulla kokonaispainolla
- SV** Vid fordonets tillåtna totalvikt
- NOR** Ved kjøretøyetts tillatte totalvekt
- PL** W przypadku największej dozwolonej masy całkowitej
- RU** В случае нагруженного автомобиля

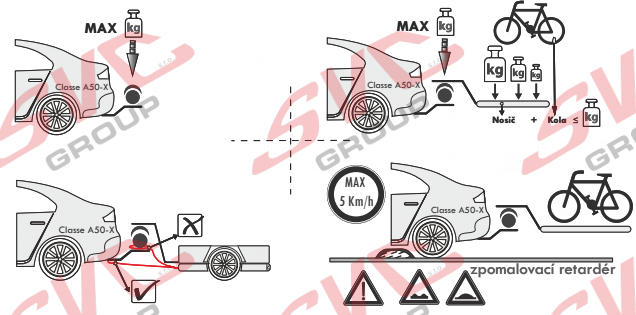
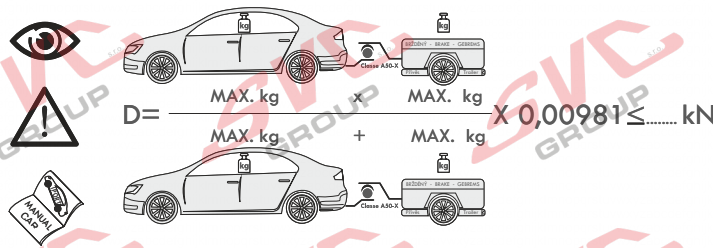
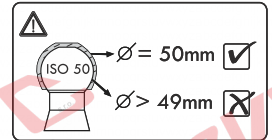

- CZ** Pokud jsou v technickém průkazu vozidla uvedené nižší hodnoty než zveřejněné k dokumentaci výrobku. Jsou tyto hodnoty výrobce vozu směrodatné pro zapsání do technického průkazu vozidla.
- SK** Pokiaľ sú v technickom preukaze vozidla uvedené nižšie hodnoty než zverejnené k dokumentácii výrobku. Sú tieto hodnoty výrobcu vozidla smerodajné pre zapísanie do technického preukazu vozidla.
- EN** If the vehicle's certificate of roadworthiness indicates lower values than those published in the product documentation. These values by the vehicle manufacturer are decisive for the entering into the vehicle's certificate of roadworthiness.
- DE** Falls im KFZ-Brief des Fahrzeugs niedrigere, als in der Dokumentation des Produkts veröffentlichte Werte angeführt sind, sind diese Werte des Fahrzeugherstellers für den Eintrag in den KFZ-Brief des Fahrzeugs maßgebend.
- HU** Amennyiben a forgalmi engedélybe jegyzett adatok a gépjármű dokumentációjában feltüntetett adatoktól alacsonyabb értékeket lennének, úgy a gépjármű gyártója által megadott és a forgalmi engedélybe pontosan bejegyzendő adatokat kell irányadóként minősíteni.
- FR** Si, sur la carte grise du véhicule, vous trouvez des valeurs inférieures à celles publiées dans la documentation du produit, les valeurs du fabricant du véhicule sont déterminantes et devront être inscrites sur la carte grise du véhicule.
- IT** Se nella carta di circolazione del veicolo sono riportati valori inferiori a quelli indicati nella documentazione del prodotto. Questi valori del produttore del veicolo sono decisivi per la registrazione nella carta di circolazione del veicolo.
- NL** Als in het kentekenbewijs van het voertuig lagere waarden vermeld staan dan gepubliceerd in de productdocumentatie, dan zijn deze waarden van de fabrikant van het voertuig bindend voor inschrijving in het kentekenbewijs van het voertuig.
- ES** Si en la ficha técnica del vehículo se indican valores menores que los publicados en la documentación del producto, estos valores facilitados por el fabricante del vehículo son decisivos para la inscripción en la ficha técnica del vehículo.
- FIN** Jos ajoneuvon rekisteriötöessa on esitetty alempia arvoja kuin tuotteen dokumentaatiossa esitetty, ovat nämä ajoneuvon valmistajan antamat arvot ratkaisevia ajoneuvon rekisteriötöeseen merkitsemistä varten.
- SV** Om det i fordonets registreringsbevis nns angivna lägre värden än de som är angivna i produktens dokumentation, är dessa värden från fordonets tillverkare riktgivande för det som antecknas i fordonets registreringsbevis.
- NOR** Dersom det i kjøretøyetts vognkort er oppgitt lavere verdier enn de som er oppgitt i produktdokumentasjon, er disse angivelsene fra kjøretøysprodusenten retningsgivende for å noteres ned i kjøretøyetts vognkort.
- PL** Jeżeli w dowodzie rejestracyjnym pojazdu są podane wartości niższe od tych, które znajdują się w dokumentacji wyrobu, to te dane producenta samochodu są miodrajne do wpisania ich do dowodu rejestracyjnego pojazdu.
- RU** Если в паспорте транспортного средства указаны более низкие значения, чем указанные в документации на изделие, эти значения производителя являются определяющими для записи в паспорт транспортного средства.



CZ Pozor informace k záruce
SK Pozor informácie k záruke
EN Note the warranty information
DE Beachten Sie die Garantieinformationen

HU Vegye gyelembe a jótállási információkat
FR Notez les informations de garantie
IT Nota le informazioni sulla garanzia
NL Let op de garantie-informatie

ES Atención
FIN Huomio
PL Uwaga
RU Внимание

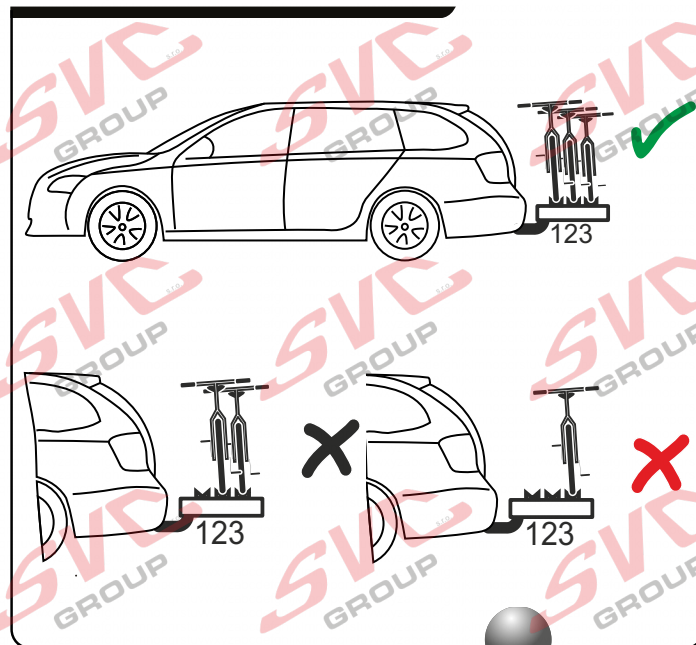
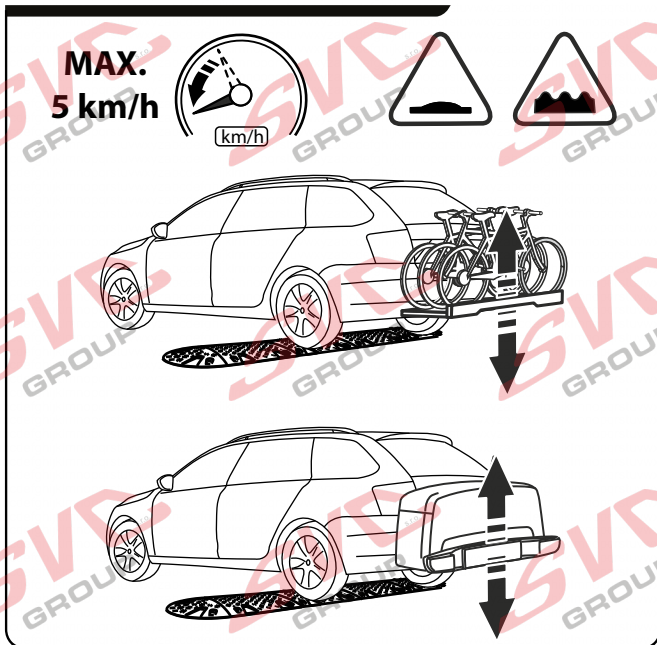
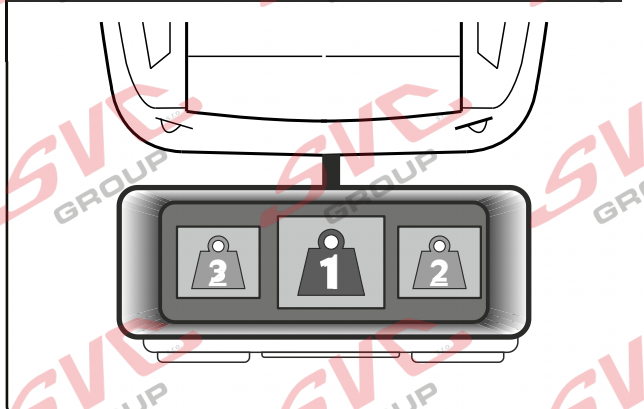
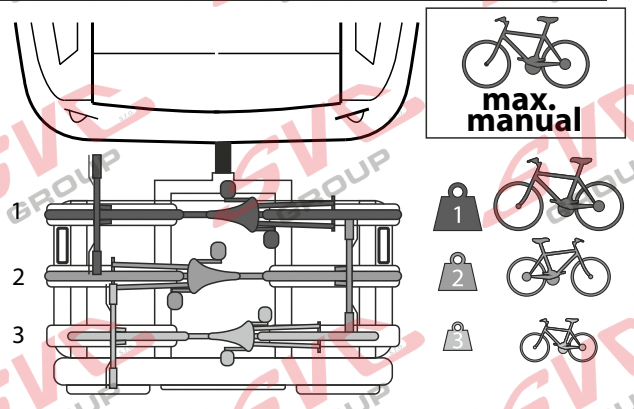
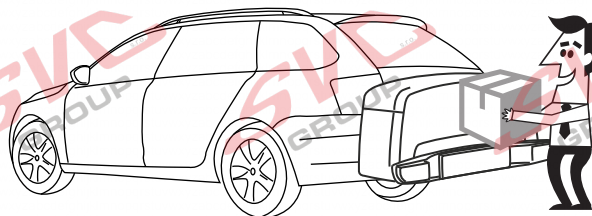
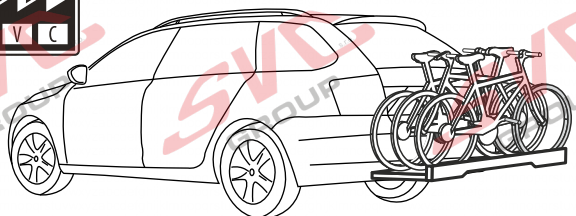

Vysokov 179
 547 01 Náchod, Česká Republika

+420 603 360 607 +420 491421021



www.svcgroup.cz



- CZ** Pozor informace k záruce
- SK** Pozor informácie k záruke
- EN** Note the warranty information
- DE** Beachten Sie die Garantieinformationen

- HU** Vegye gyelembe a jótállási információkat
- FR** Notez les informations de garantie
- IT** Nota le informazioni sulla garanzia
- NL** Let op de garantie-informatie

- ES** Atención
- FIN** Huomio
- PL** Uwaga
- RU** Внимание

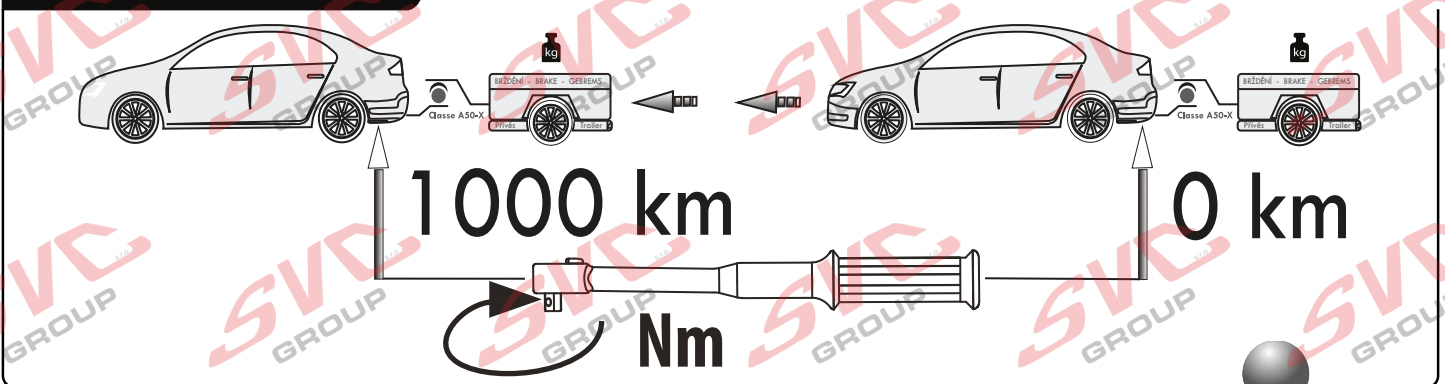
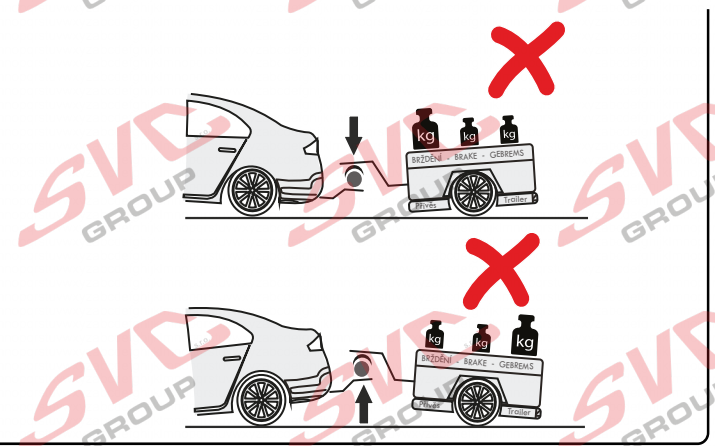
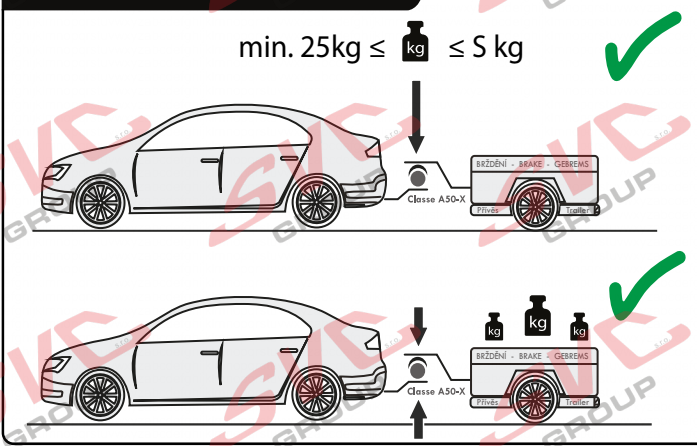
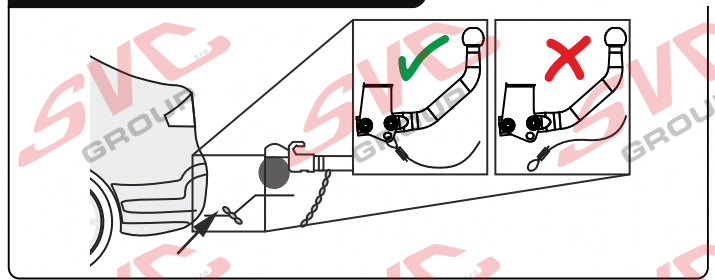
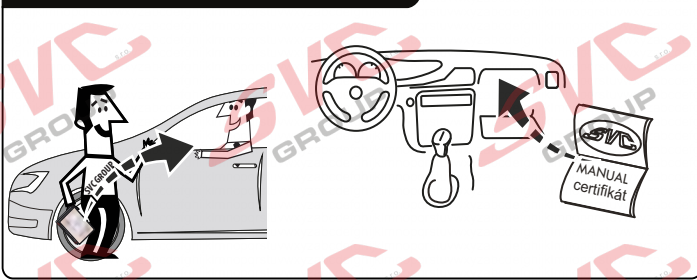
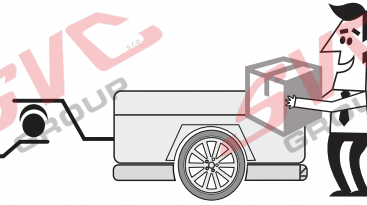
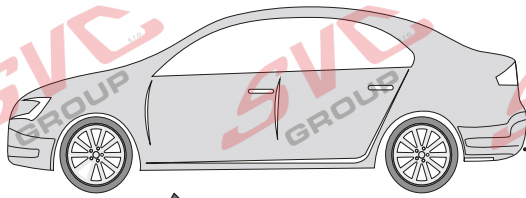

Vysokov 179
547 01 Náchod, Česká Republika

+420 603 360 607 +420 491421021



www.svcgroup.cz

SVC GROUP ©-08-2019

Service Vitver Centrum

Nevíte si rady? Potřebujete poradit?

Náš zákaznický servis je vám k dispozici

 +420 491 421 021

 svc@svcgroup.cz



Opravdový specialista a Certifikovaný výrobce tažných zařízení s největším sortimentem v ČR. Rodinná firma s více jak 30letou ověřenou tradicí výroby, prodeje a montáže.

www.svcgroup.cz