

- DE Gebrauchsanleitung
- FR Mode d'emploi
- NL Gebruikershandleiding
- GB User guide
- ES Guía del usuario
- IT Manuale di istruzioni
- SE Bruksanvisning
- CZ Uživatelská příručka
- DK Brugervejledning
- FI Käyttöohjeet
- GR Οδηγός χρήστη
- NO Brukerveiledning
- PL Instrukcja obsługi

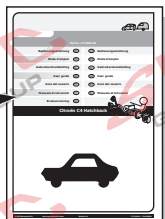

Partnr.: CR-041-DH

Gebrauchsanleitung DE

CZ Uživatelská příručka

Mode d'emploi FR

DK Brugervejledning

Gebruikershandleiding NL

FI Käyttöohjeet

User guide GB

GR Οδηγός χρήστη

Guía del usuario ES

NO Brukerveiledning

Manuale di istruzioni IT

PL Instrukcja obsługi

Bruksanvisning SE

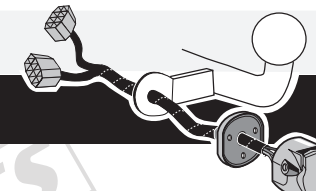

JEEP Wrangler JK (3&5 Drs.) 01/2007>>08/2018
 JEEP Wrangler JL (3&5 Drs.) 09/2018>>

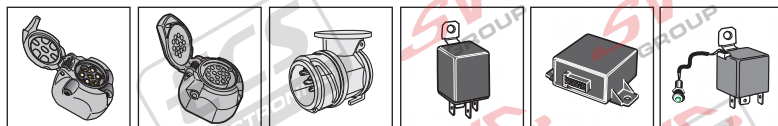

SPARE PARTS

www.ecs-electronics.com

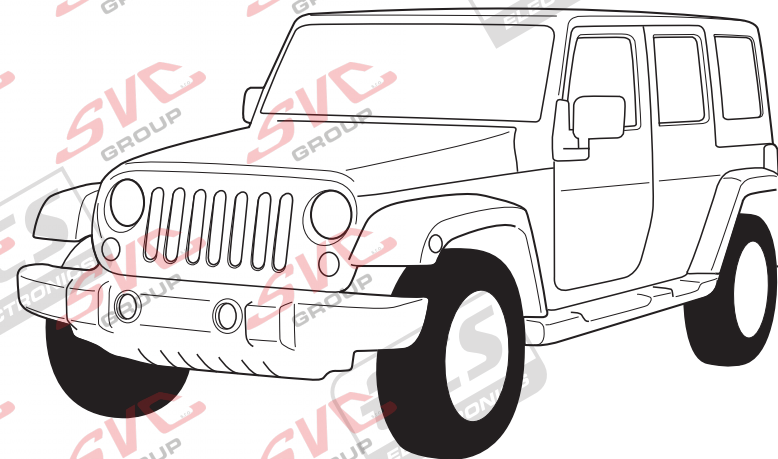

(DE) Anschluss Steckdose
 (FR) Connection de la prise
 (NL) Contactdoos aansluiting
 (GB) Socket connection

(ES) Conexión de la caja de enchufe
 (IT) Allaccio zoccolo
 (SE) Anslutning kontaktdosa

(CZ) Objímkový konektor
 (DK) Stikdåse forbindelse
 (FI) Pistorasias liitäntä

(GR) Υποδοχή σύνδεσης
 (NO) Tilkobling koblingsboks
 (PL) Połączenie przez gniazdo

DIN/ISO 11446	1/L	2	2a	3/31	4/R	5/58-R	6/54	7/58-L	8	9	10	11	12	13	9
Pmax	21W	2x21W	Grau	Weiß	Grün	52W	3x21W	52W	Schwarz/ Rot	Braun/ Weiß	180W/15Amp	180W/15Amp	Rot/ Blau	13	—
(DE)	Gelb	Blau	Gris	Blanc	Vert	Braun	Rot (1,00mm ²)	Schwarz	Noir/ Rouge	Weiß	Rot (2,50mm ²)	Weiß	Rouge/ Bleu		
(FR)	Jaune	Bleu	Gris	Blanc	Vert	Marron	Rouge (1,00mm ²)	Noir	Zwart/ Rood	Marron/ Blanc	Rouge (2,50mm ²)	Blanc	Rouge/ Bleu		
(NL)	Geel	Blauw	Grijs	Wit	Groen	Bruin	Rood (1,00mm ²)	Zwart	Bruin/ Wit	Bruin/ Wit	Rood (2,50mm ²)	Wit	Rood/ Blauw		
(GB)	Yellow	Blue	Grey	White	Green	Brown	Red (1,00mm ²)	Black	Black/ Red	White	Red (2,50mm ²)	White	Red/ Blue		
(ES)	Amarillo	Azul	Gris	Blanco	Verde	Marrón	Rojo (1,00mm ²)	Negro	Negro/ Rojo	Marrón/ Blanco	Rojo (2,50mm ²)	Blanco	Rojo/ Azul		
(IT)	Giallo	Blu	Grigio	Bianco	Verde	Marrone	Rosso (1,00mm ²)	Nero	Nero/ Rosso	Marrone/ Bianco	Rosso (2,50mm ²)	Bianco	Rosso/ Blu		
(SE)	Gul	Blå	Grå	Vit	Grön	Brun	Röd (1,00mm ²)	Svart	Svart/ Röd	Brun/ Vit	Röd (2,50mm ²)	Vit	Röd/ Blå		
(CZ)	Žlutá	Modrá	Šedá	Bílá	Zelená	Hnědá	Červená (1,00mm ²)	Černá	Černo/ Červená	Hnědo/ Bílá	Červená (2,50mm ²)	Bílá	Červená/ Modrá		
(DK)	Gul	Blå	Grå	Hvid	Grøn	Brun	Rød (1,00mm ²)	Sort	Sort/ Rød	Brun/ Hvid	Rød (2,50mm ²)	Hvid	Rød/ Blå		
(FI)	Keltainen	Sininen	Harmaa	Valkoinen	Vihreä	Ruskea	Punainen (1,00mm ²)	Musta	Musta/ Punainen	Valkoinen	Punainen (2,50mm ²)	Valkoinen	Punainen/ Sininen		
(GR)	Κίτρινο	Μπλε	Γκρι	Λευκό	Πράσινο	Καφέ	Κόκκινο (1,00mm ²)	Μαύο	Μαύο/ Κόκκινο	Λευκό	Κόκκινο (2,50mm ²)	Λευκό	Κόκκινο/ Μπλε		
(NO)	Gul	Blå	Grå	Hvit	Grønn	Brun	Rød (1,00mm ²)	Svart	Svart/ Rød	Brun/ Hvit	Rød (2,50mm ²)	Hvit	Rød/ Blå		
(PL)	Żółty	Niebieski	Szary	Biały	Zielony	Brazowy	Czerwony (1,00mm ²)	Czarny	Czarny/ Czerwony	Brazowy/ Biały	Czerwony (2,50mm ²)	Biały	Czerwony/ Niebieski		

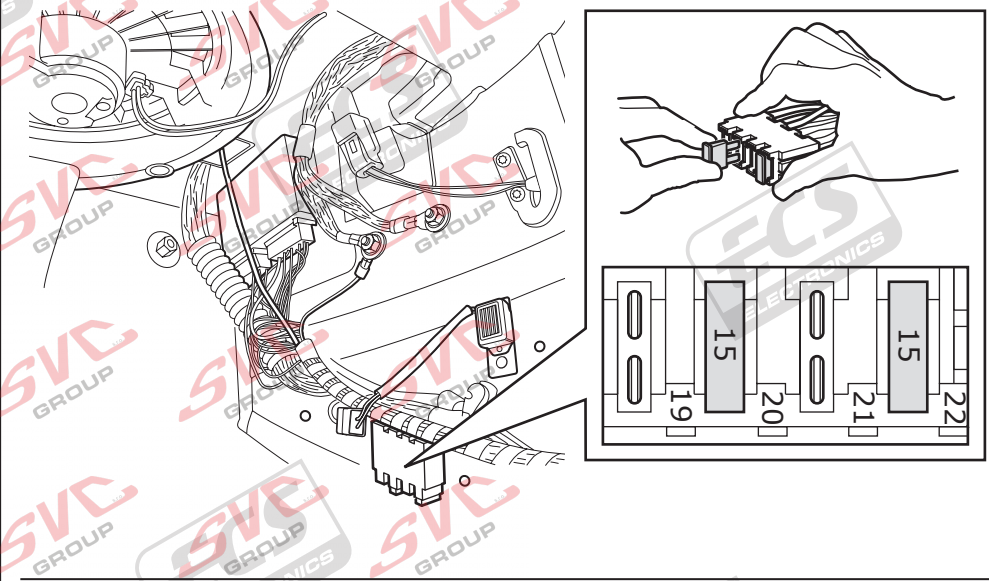
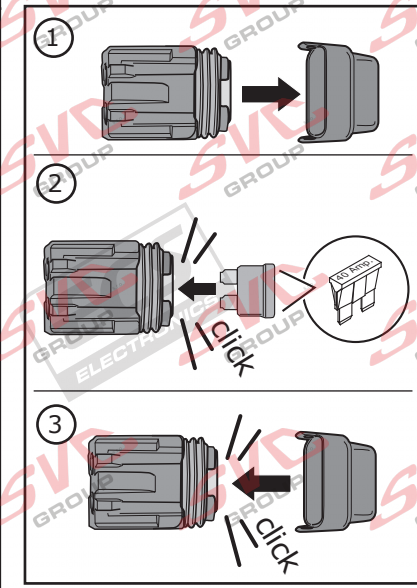

- (DE) Sicherungen austauschen
- (ES) Cambio de fusible
- (CZ) Výměna pojistky
- (GR) Αλλαγή ασφάλειας
- (FR) Remplacer les fusibles
- (IT) Sostituire i fusibili
- (DK) Udskiftning af sikringer
- (NO) Skifte sikringene
- (FI) Zekeringen vervangen
- (SE) Byte av säkringar
- (FI) Vaihtaa varokkeet
- (PL) Wymienić bezpieczniki
- (GB) Changing the fuse

INFO : Storage

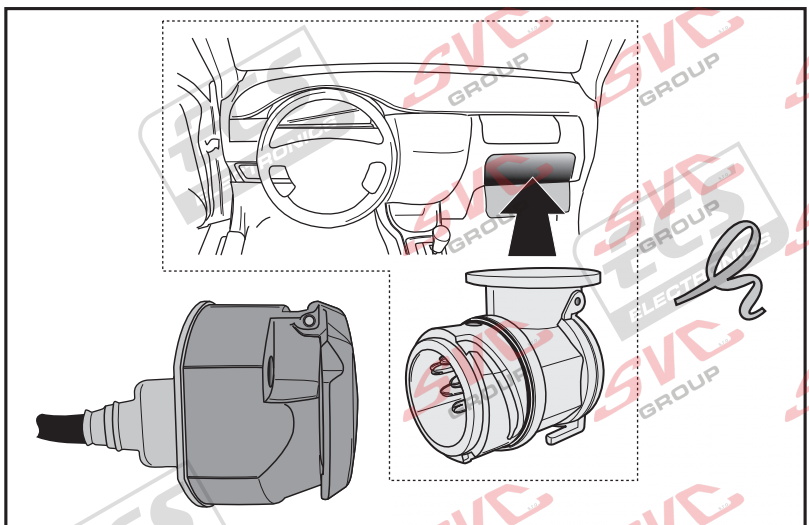
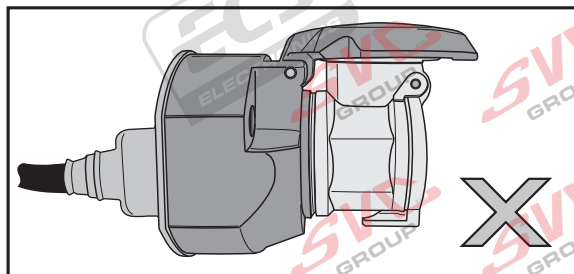
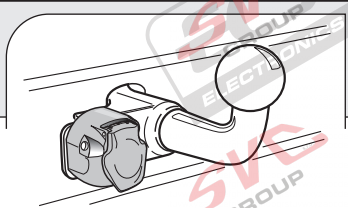
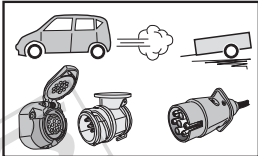

INFO

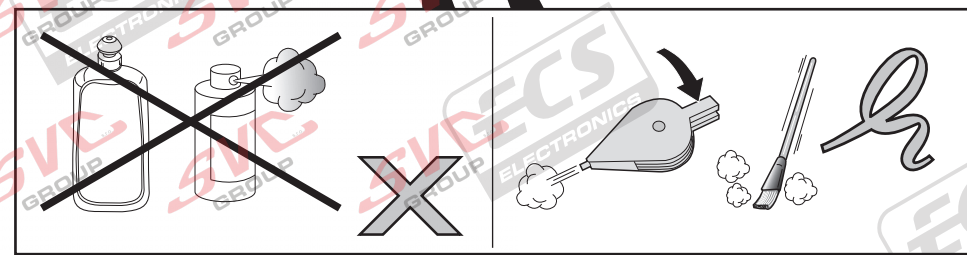
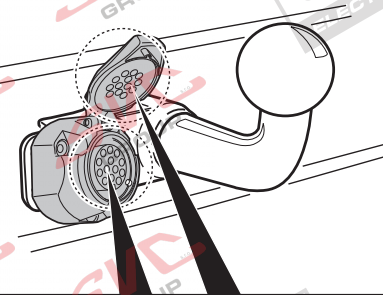
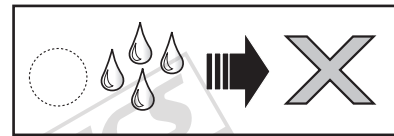
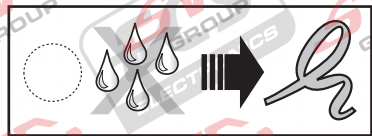
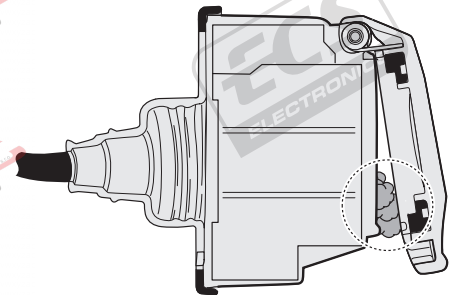
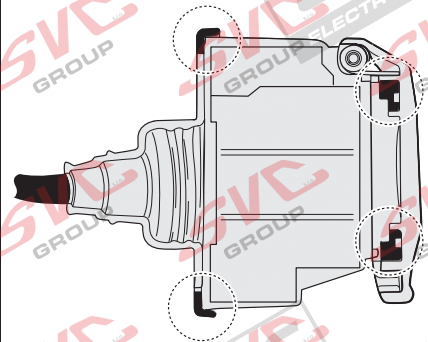
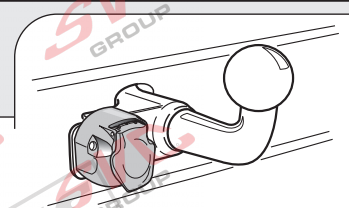
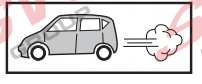

INFO : Ring.

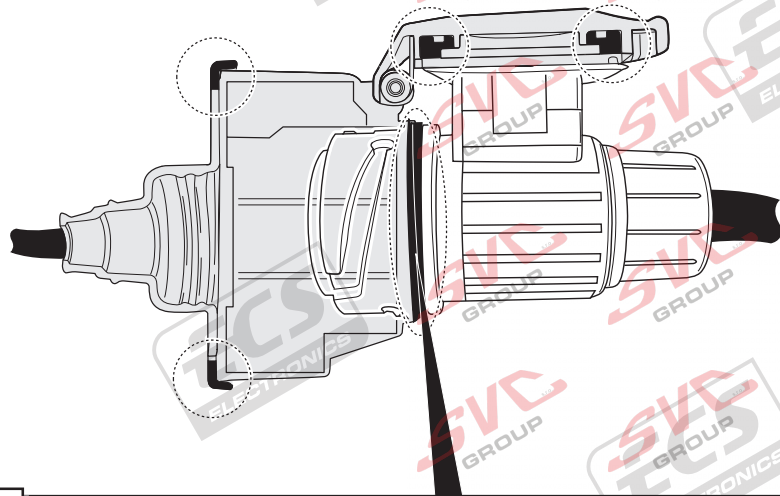
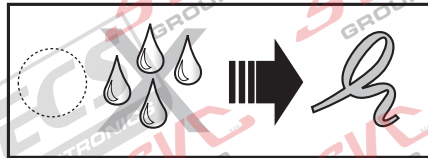
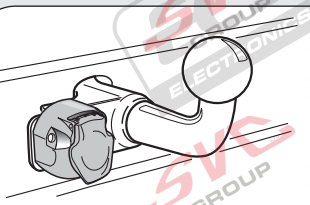
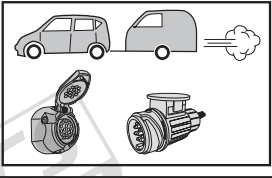

INFO

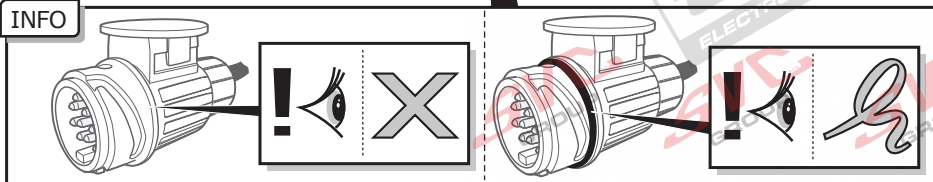

INFO : Adapt.

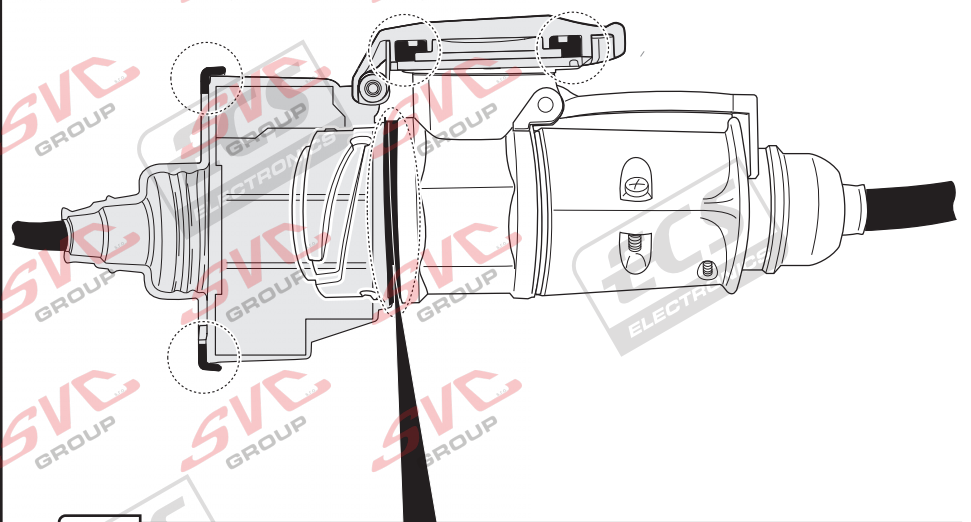
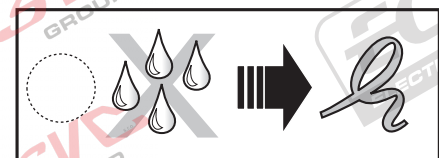
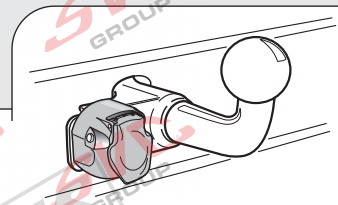
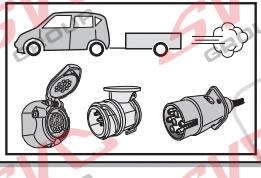

INFO

