

- (DE) Gebrauchsanleitung
- (FR) Mode d'emploi
- (NL) Gebruikershandleiding
- (GB) User guide
- (ES) Guía del usuario
- (IT) Manuale di istruzioni
- (SE) Bruksanvisning
- (CZ) Uživatelská příručka
- (DK) Brugervejledning
- (FI) Käyttöohjeet
- (GR) Οδηγός χρήστη
- (NO) Brukerveiledning
- (PL) Instrukcja obsługi

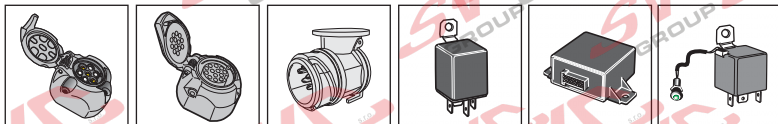

SPARE PARTS

www.ecs-electronics.com

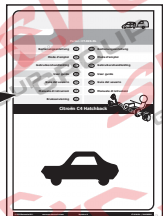
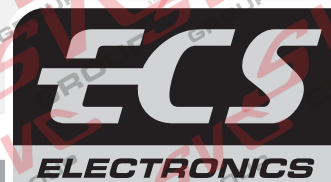





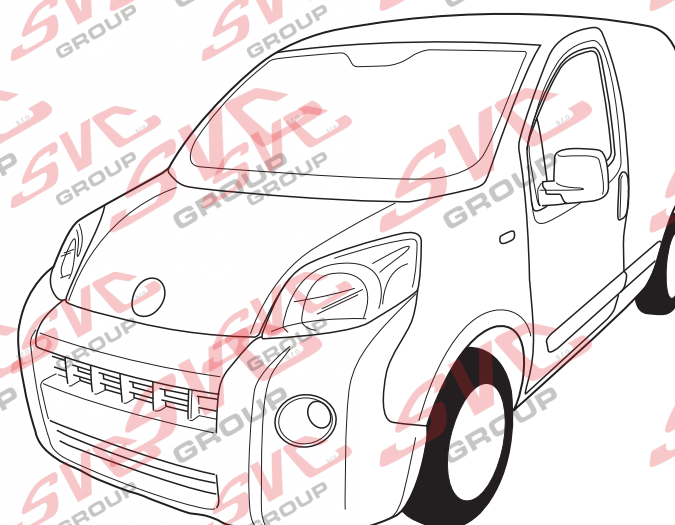
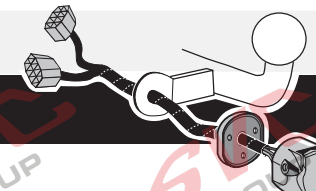

Partnr.: FI-024-BQ

Gebrauchsanleitung (DE)	(CZ) Uživatelská příručka
Mode d'emploi (FR)	(DK) Brugervejledning
Gebruikershandleiding (NL)	(FI) Käyttöohjeet
User guide (GB)	(GR) Οδηγός χρήστη
Guía del usuario (ES)	(NO) Brukerveiledning
Manuale di istruzioni (IT)	(PL) Instrukcja obsługi
Bruksanvisning (SE)	

Fiat Fiorino & Qubo 02/2008 >>
 Peugeot Bipper & Bipper Tepee 02/2008 >>
 Citroën Nemo & Nemo Combi 02/2008 >>



- | | |
|-------------------------------------|-------------------------------|
| (DE) Anschluss Steckdose | (CZ) Objímkový konektor |
| (FR) Connection de la prise | (DK) Stikdåse forbindelse |
| (NL) Contactdoos aansluiting | (FI) Pistorasia liitäntä |
| (GB) Socket connection | (GR) Υποδοχή σύνδεσης |
| (ES) Conexión de la caja de enchufe | (NO) Tilkobling koblingsboks |
| (IT) Allaccio zoccolo | (PL) Połączenie przez gniazdo |
| (SE) Anslutning kontaktdosa | |

DIN/ISO 1724			 1-7				
	1/L	2	3/31	4/R	5/58-R	6/54	7/58-L
Pmax	21W	2x21W		21W	52W	3x21W	52W
(DE)	Gelb	Blau	Weiß	Grün	Braun	Röt	Schwarz
(FR)	Jaune	Bleu	Blanc	Vert	Marron	Rouge	Noir
(NL)	Geel	Blauw	Wit	Groen	Bruin	Rood	Zwart
(GB)	Yellow	Blue	White	Green	Brown	Red	Black
(ES)	Amarillo	Azul	Bianco	Verde	Marrón	Rojo	Negro
(IT)	Giallo	Blu	Bianco	Verde	Marrone	Rosso	Nero
(SE)	Gul	Blå	Vit	Grön	Brun	Röd	Svart
(CZ)	Žlutá	Modrá	Bílá	Zelená	Hnědá	Červená	Černá
(DK)	Gul	Blå	Hvid	Grøn	Brun	Rød	Sort
(FI)	Keltainen	Sininen	Valkoinen	Vihreä	Ruskea	Punainen	Musta
(GR)	Κίτρινο	Μπλε	Λευκό	Πράσινο	Καφέ	Κόκκινο	Μαύρο
(NO)	Gul	Blå	Hvit	Grønn	Brun	Rød	Svart
(PL)	Żółty	Niebieski	Biały	Zielony	Brązowy	Czerwony	Czarny

- | | | | |
|------------------------------|----------------------------|-------------------------------|----------------------------|
| (DE) Sicherungen austauschen | (ES) Cambio de fusible | (CZ) Výměna pojistky | (GR) Αλλαγή ασφάλειας |
| (FR) Remplacer les fusibles | (IT) Sostituire i fusibili | (DK) Udskiftning af sikringer | (NO) Skifte sikringene |
| (NL) Zekeringen vervangen | (SE) Byte av säkringar | (FI) Vaihtaa varokkeet | (PL) Wymienić bezpieczniki |
| (GB) Changing the fuse | | | |

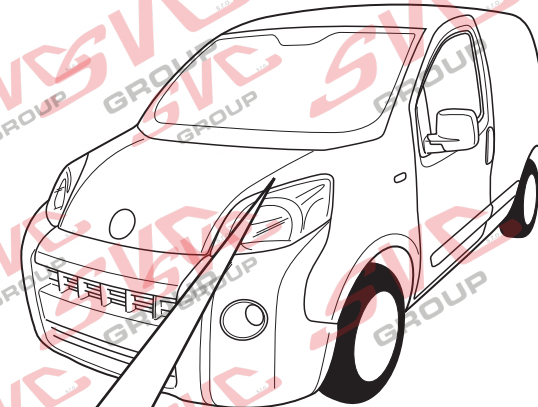

- | | | |
|----------------|-------------------|---|
| (DE) Orange | (CZ) Oranžová | 15 Amp.
 |
| (FR) Orange | (DK) Orange | |
| (NL) Oranje | (FI) Oranssi |  |
| (GB) Orange | (GR) Πορτοκαλί | |
| (ES) Naranja | (NO) Oransje | |
| (IT) Arancione | (PL) Pomarańczowy | |
| (SE) Orange | | |

INFO : Storage

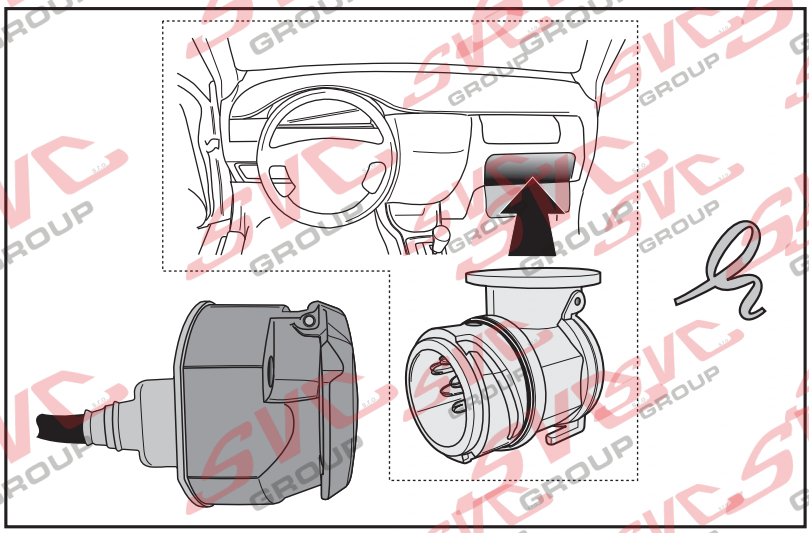
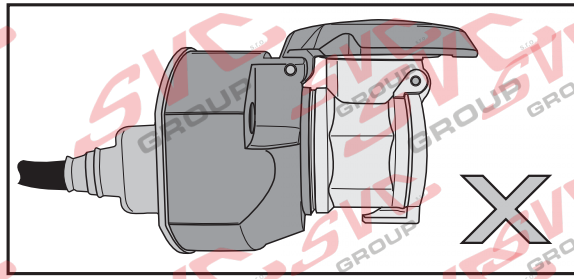
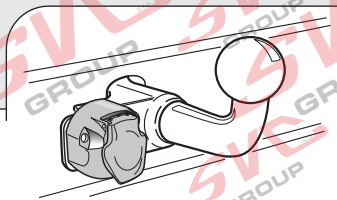
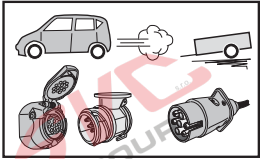

INFO

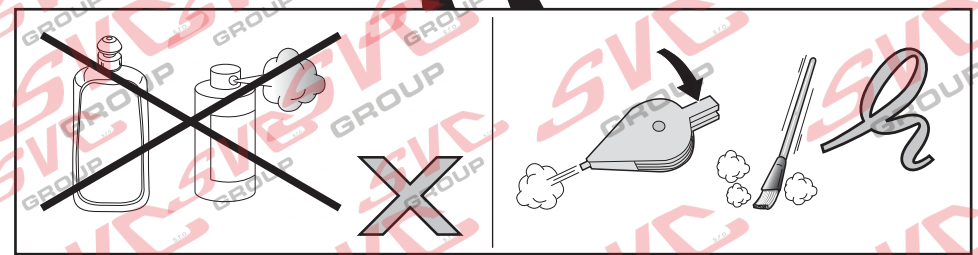
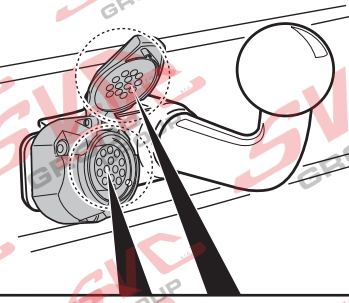
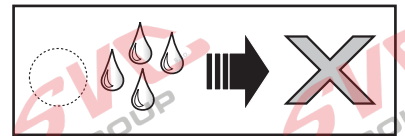
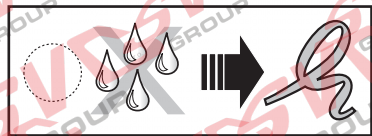
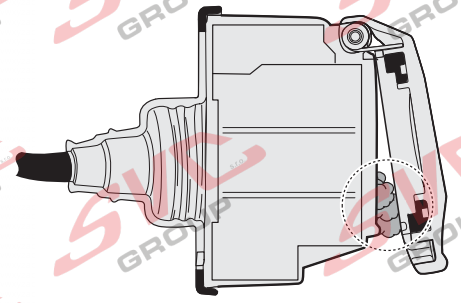
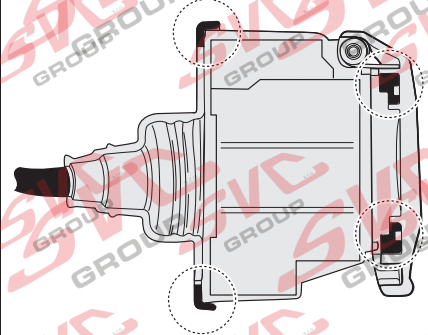
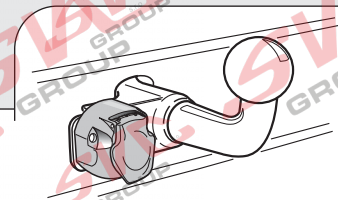
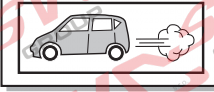

INFO : Ring.

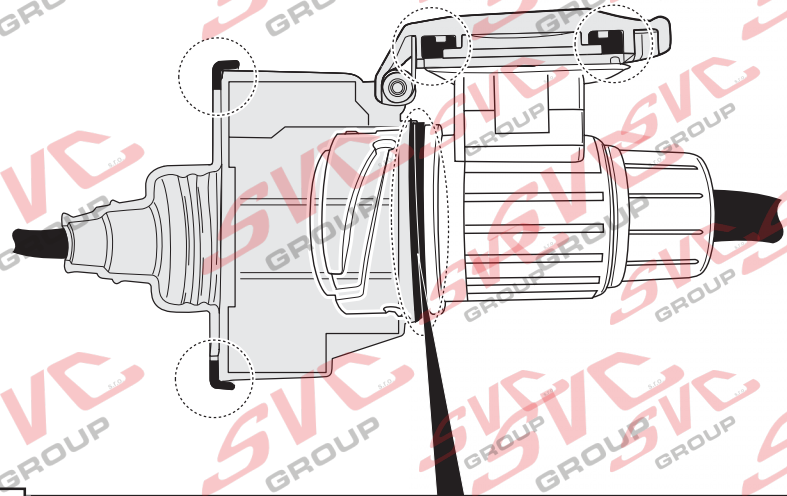
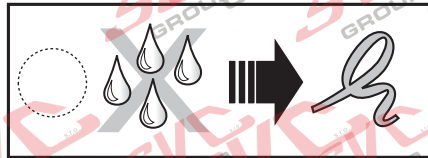
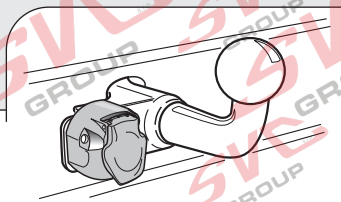
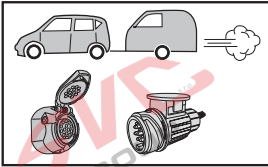

INFO

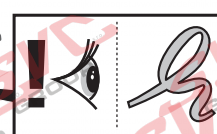
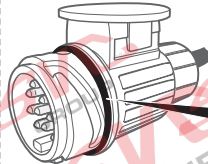
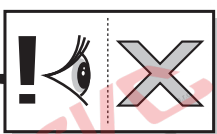
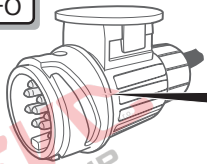

INFO : Adapt.

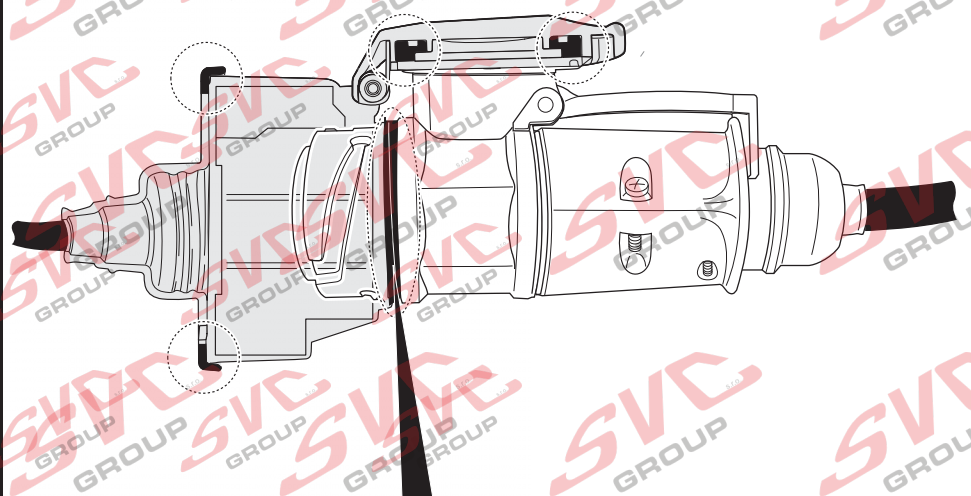
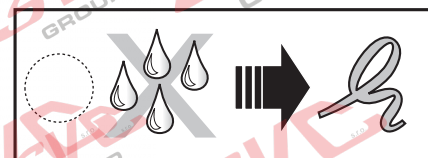
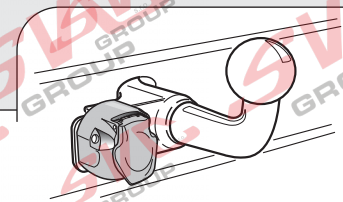
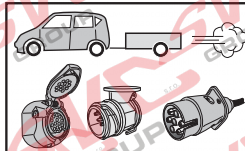

INFO

