

- DE Gebrauchsanleitung
- FR Mode d'emploi
- NL Gebruikershandleiding
- GB User guide
- ES Guía del usuario
- IT Manuale di istruzioni
- SE Bruksanvisning
- CZ Uživatelská příručka
- DK Brugervejledning
- FI Käyttöohjeet
- GR Οδηγός χρήστη
- NO Brukerveiledning
- PL Instrukcja obsługi

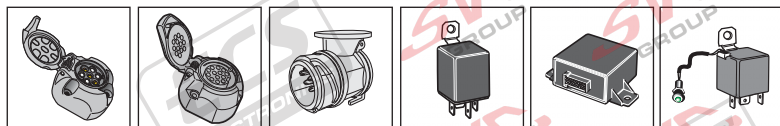

SPARE PARTS

www.ecs-electronics.com

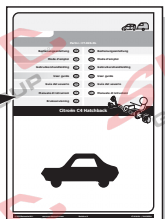

Partnr.: FI-024-BQ

Gebrauchsanleitung (DE)

Mode d'emploi (FR)

Gebruikershandleiding (NL)

User guide (GB)

Guía del usuario (ES)

Manuale di istruzioni (IT)

Bruksanvisning (SE)

(CZ) Uživatelská příručka

(DK) Brugervejledning

(FI) Käyttöohjeet

(GR) Οδηγός χρήστη

(NO) Brukerveiledning

(PL) Instrukcja obsługi

Fiat Fiorino & Qubo 02/2008 >>
 Peugeot Bipper & Bipper Tepee 02/2008 >>
 Citroën Nemo & Nemo Combi 02/2008 >>

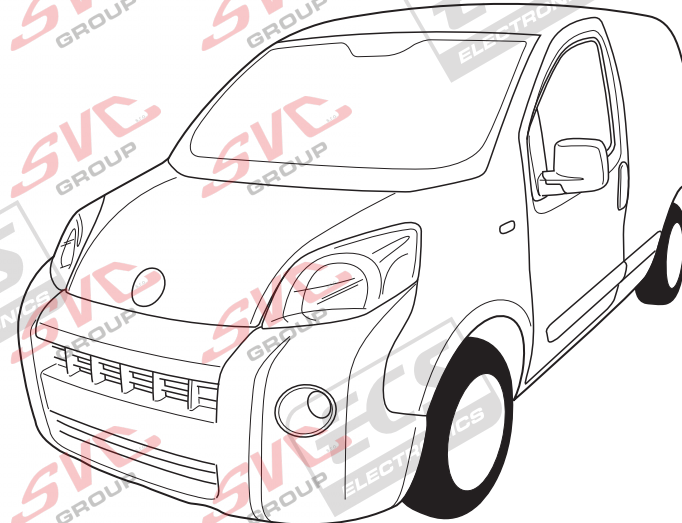
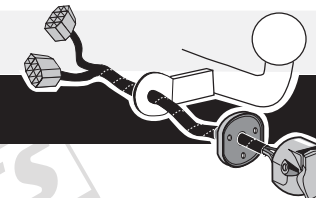

- (DE) Anschluss Steckdose (CZ) Objímkový konektor
 (FR) Connection de la prise (DK) Stikdåse forbindelse
 (NL) Contactdoos aansluiting (FI) Pistorasia liitäntä
 (GB) Socket connection (GR) Υποδοχή σύνδεσης
 (ES) Conexión de la caja de enchufe (NO) Tilkobling koblingsboks
 (IT) Allaccio zoccolo (PL) Połączenie przez gniazdo
 (SE) Anslutning kontaktdosa

| DIN/ISO 1724 | ← |  | ⏚ 1-7 | → |  |  |  |
|--------------|-----------|---|-----------|---------|---|---|---|
| | 1/L | 2 | 3/31 | 4/R | 5/58-R | 6/54 | 7/58-L |
| Pmax | 21W | 2x21W | | 21W | 52W | 3x21W | 52W |
| (DE) | Gelb | Blau | Weiß | Grün | Braun | Röt | Schwarz |
| (FR) | Jaune | Bleu | Blanc | Vert | Marron | Rouge | Noir |
| (NL) | Geel | Blauw | Wit | Groen | Bruin | Rood | Zwart |
| (GB) | Yellow | Blue | White | Green | Brown | Red | Black |
| (ES) | Amarillo | Azul | Blanco | Verde | Marrón | Rojo | Negro |
| (IT) | Giallo | Blu | Bianco | Verde | Marrone | Rosso | Nero |
| (SE) | Gul | Blå | Vit | Grön | Brun | Röd | Svart |
| (CZ) | Žlutá | Modrá | Bílá | Zelená | Hnědá | Červená | Černá |
| (DK) | Gul | Blå | Hvid | Grøn | Brun | Rød | Sort |
| (FI) | Keltainen | Sininen | Valkoinen | Vihreä | Ruskea | Punainen | Musta |
| (GR) | Κίτρινο | Μπλε | Λευκό | Πράσινο | Καφέ | Κόκκινο | Μαύρο |
| (NO) | Gul | Blå | Hvit | Grønn | Brun | Rød | Svart |
| (PL) | Żółty | Niebieski | Biały | Zielony | Brązowy | Czerwony | Czarny |

- (DE) Sicherungen austauschen (ES) Cambio de fusible (CZ) Výměna pojistky (GR) Αλλαγή ασφάλειας
 (FR) Remplacer les fusibles (IT) Sostituire i fusibili (DK) Udskiftning af sikringer (NO) Skifte sikringene
 (NL) Zekeringen vervangen (SE) Byte av säkringar (FI) Vaihtaa varokkeet (PL) Wymienić bezpieczniki
 (GB) Changing the fuse

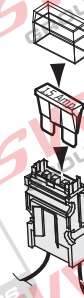
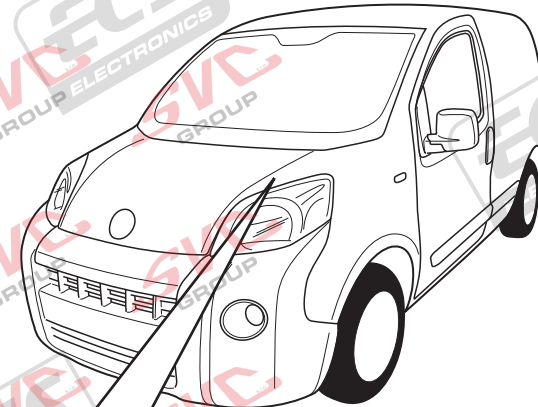

15 Amp. 

| | |
|----------------|-------------------|
| (DE) Orange | (CZ) Oranžová |
| (FR) Orange | (DK) Orange |
| (NL) Oranje | (FI) Oranssi |
| (GB) Orange | (GR) Πορτοκαλί |
| (ES) Naranja | (NO) Oransje |
| (IT) Arancione | (PL) Pomarańczowy |
| (SE) Orange | |



INFO : Storage

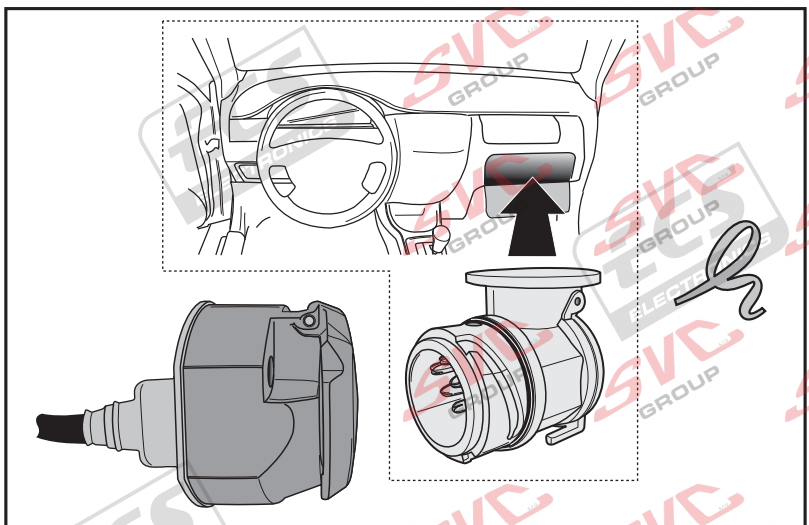
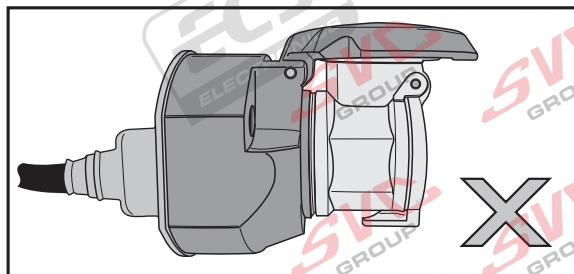
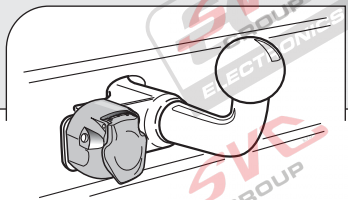
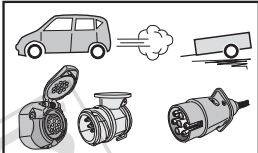

INFO

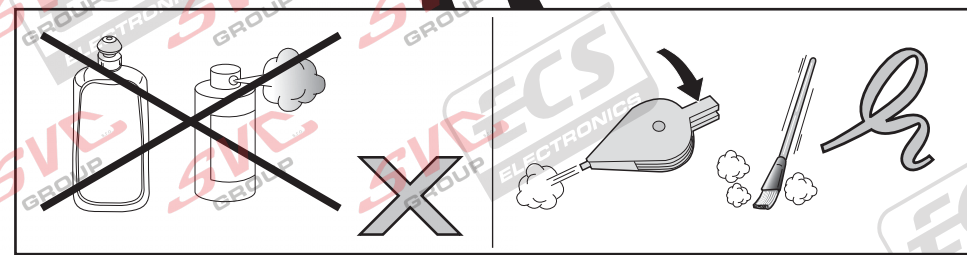
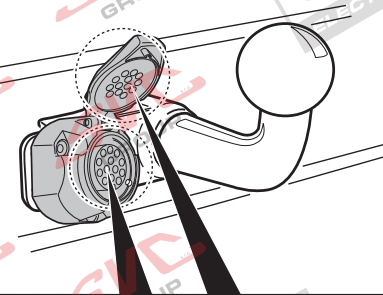
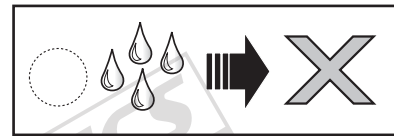
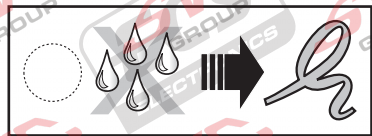
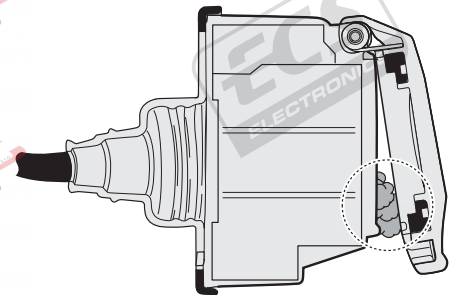
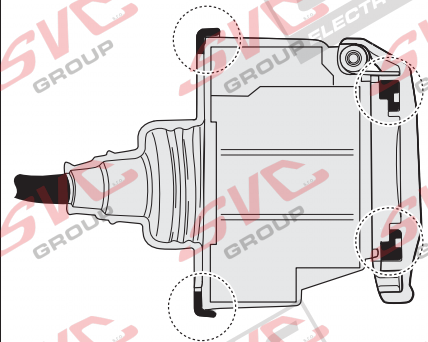
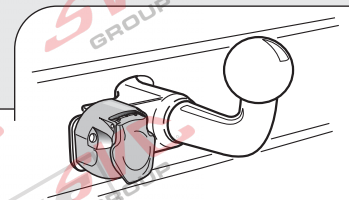
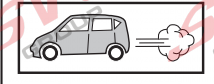

INFO : Ring.

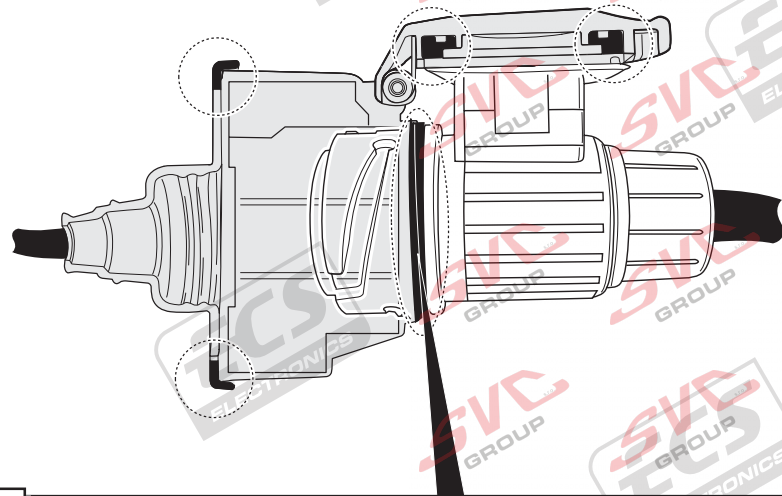
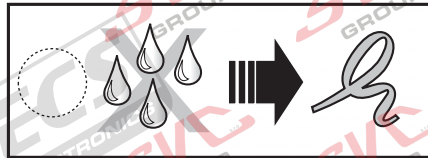
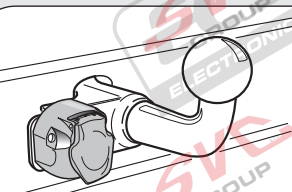
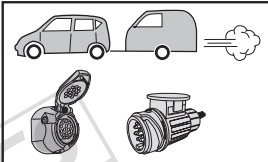

INFO

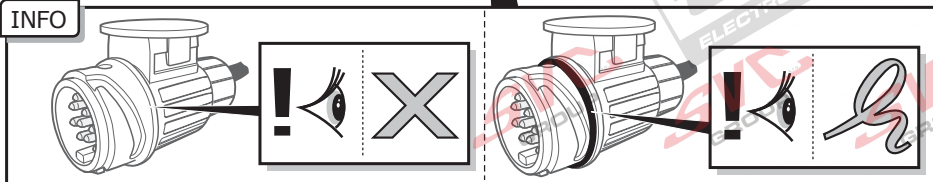

INFO : Adapt.

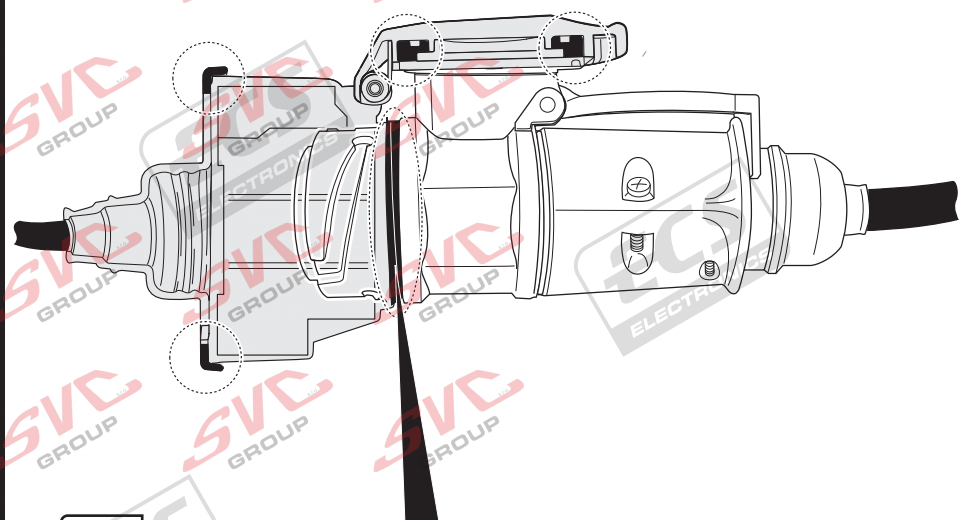
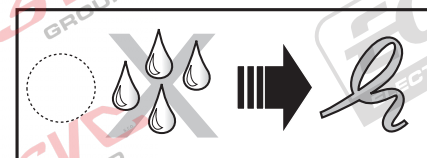
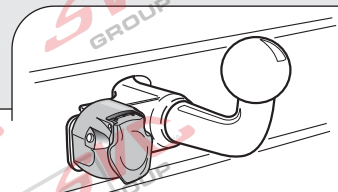
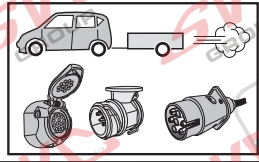

INFO

