

- DE Gebrauchsanleitung
- FR Mode d'emploi
- NL Gebruikershandleiding
- GB User guide
- ES Guía del usuario
- IT Manuale di istruzioni
- SE Bruksanvisning
- CZ Uživatelská příručka
- DK Brugervejledning
- FI Käyttöohjeet
- GR Οδηγός χρήστη
- NO Brukerveiledning
- PL Instrukcja obsługi

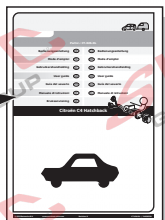

Partnr.: MB-070-D1

- |                       |    |    |                      |
|-----------------------|----|----|----------------------|
| Gebrauchsanleitung    | DE | CZ | Uživatelská příručka |
| Mode d'emploi         | FR | DK | Brugervejledning     |
| Gebruikershandleiding | NL | FI | Käyttöohjeet         |
| User guide            | GB | GR | Οδηγός χρήστη        |
| Guía del usuario      | ES | NO | Brukerveiledning     |
| Manuale di istruzioni | IT | PL | Instrukcja obsługi   |
| Bruksanvisning        | SE |    |                      |

Mercedes Vito / Viano 08/2005-

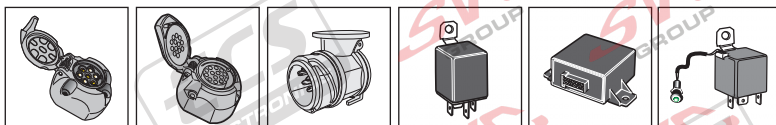
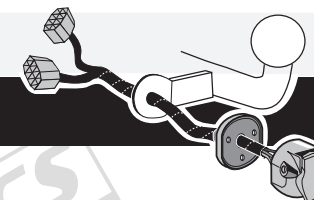

**SPARE PARTS**

[www.ecs-electronics.com](http://www.ecs-electronics.com)

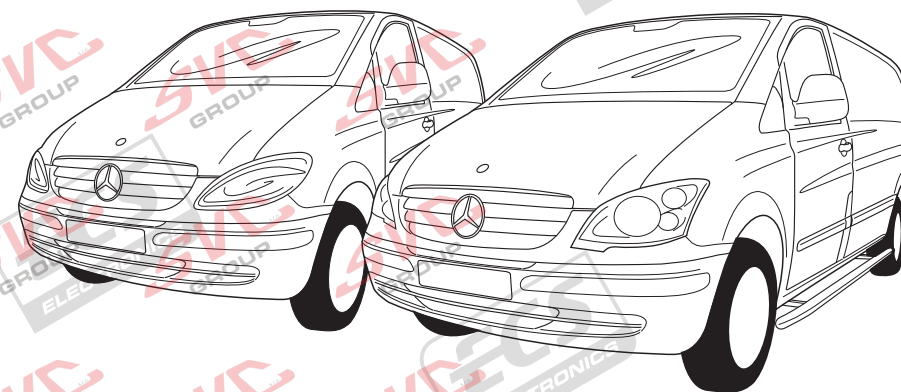

- Anschluss Steckdose
- Connection de la prise
- Contactdoos aansluiting
- Socket connection
- Conexión de la caja de enchufe
- Allaccio zoccolo
- Anslutning kontaktdosa
- Objímákový konektor
- Stikdåse forbindelse
- Pistorasias liitäntä
- Υνοδοχή σύνδεσης
- Tilkobling koblingsboks
- Połączenie przez gniazdo

DIN/ISO 11446	↩		1-8	↔		6/54	7/58-L		8		9	10	11	12	13	↕ 9
Pmax	1/L 21W	2 2x21W	3/31	4/R 21W	5/58-R 52W	6/54 3x21W	7/58-L 52W	8 2x21W	9 180W/15Amp	10 180W/15Amp	11 180W/15Amp	12 180W/15Amp	13 180W/15Amp	14 180W/15Amp	15 180W/15Amp	16 180W/15Amp
	Gelb	Blau	Weiß	Grün	Braun	Rot (1,00mm <sup>2</sup> )	Schwarz	Schwarz/ Rot	Braun/ Weiß	Rot (2,50mm <sup>2</sup> )	Rot (2,50mm <sup>2</sup> )	Weiß	Weiß	-	-	Weiß
	Jaune	Bleu	Blanc	Vert	Marron	Rouge (1,00mm <sup>2</sup> )	Noir	Noir/ Rouge	Marron/ Blanc	Rouge (2,50mm <sup>2</sup> )	Rouge (2,50mm <sup>2</sup> )	Blanc	Blanc	-	-	Blanc
	Geel	Blauw	Wit	Groen	Bruin	Rood (1,00mm <sup>2</sup> )	Zwart	Zwart/ Rood	Bruin/ Wit	Rood (2,50mm <sup>2</sup> )	Rood (2,50mm <sup>2</sup> )	Wit	Wit	-	-	Wit
	Yellow	Blue	White	Green	Brown	Red (1,00mm <sup>2</sup> )	Black	Black/ Red	Brown/ White	Red (2,50mm <sup>2</sup> )	Red (2,50mm <sup>2</sup> )	White	White	-	-	White
	Amarillo	Azul	Bianco	Verde	Marrón	Rojo (1,00mm <sup>2</sup> )	Negro	Negro/ Rojo	Marrón/ Blanco	Rojo (2,50mm <sup>2</sup> )	Rojo (2,50mm <sup>2</sup> )	Blanco	Blanco	-	-	Blanco
	Giallo	Blu	Bianco	Verde	Marrone	Rosso (1,00mm <sup>2</sup> )	Nero	Nero/ Rosso	Bianco/ Marrone	Rosso (2,50mm <sup>2</sup> )	Rosso (2,50mm <sup>2</sup> )	Blanco	Blanco	-	-	Blanco
	Gul	Blå	Vit	Grön	Brun	Röd (1,00mm <sup>2</sup> )	Svart	Svart/ Röd	Brun/ Vit	Röd (2,50mm <sup>2</sup> )	Röd (2,50mm <sup>2</sup> )	Vit	Vit	-	-	Vit
	Žlutá	Modrá	Bílá	Zelená	Hnědá	Červená (1,00mm <sup>2</sup> )	Černá	Černo/ Červená	Hnědo/ Bílá	Červená (2,50mm <sup>2</sup> )	Červená (2,50mm <sup>2</sup> )	Bílá	Bílá	-	-	Bílá
	Gul	Blå	Hvid	Grøn	Brun	Rød (1,00mm <sup>2</sup> )	Sort	Sort/ Rød	Brun/ Hvid	Rød (2,50mm <sup>2</sup> )	Rød (2,50mm <sup>2</sup> )	Hvid	Hvid	-	-	Hvid
	Keltainen	Sininen	Valkoinen	Vihreä	Ruskea	Punainen (1,00mm <sup>2</sup> )	Musta	Musta/ Punainen	Ruskea/ Valkoinen	Punainen (2,50mm <sup>2</sup> )	Punainen (2,50mm <sup>2</sup> )	Valkoinen	Valkoinen	-	-	Valkoinen
	Κίτρινο	Μπλε	Λευκό	Πράσινο	Καφέ	Κόκκινο (1,00mm <sup>2</sup> )	Μαύο	Μαύο/ Κόκκινο	Καφέ/ Λευκό	Κόκκινο (2,50mm <sup>2</sup> )	Κόκκινο (2,50mm <sup>2</sup> )	Λευκό	Λευκό	-	-	Λευκό
	Gul	Blå	Hvit	Grønn	Brun	Rød (1,00mm <sup>2</sup> )	Svart	Svart/ Rød	Brun/ Hvit	Rød (2,50mm <sup>2</sup> )	Rød (2,50mm <sup>2</sup> )	Hvit	Hvit	-	-	Hvit
	Żółty	Niebieski	Biały	Zielony	Brazowy	Czerwony (1,00mm <sup>2</sup> )	Czarny	Czarny/ Czerwony	Brazowy/ Biały	Czerwony (2,50mm <sup>2</sup> )	Czerwony (2,50mm <sup>2</sup> )	Biały	Biały	-	-	Biały

- |                            |                          |                             |                          |
|----------------------------|--------------------------|-----------------------------|--------------------------|
| DE Sicherungen austauschen | ES Cambio de fusible     | CZ Výměna pojistky          | GR Αλλαγή ασφάλειας      |
| FR Remplacer les fusibles  | IT Sostituire i fusibili | DK Udskiftning af sikringer | NO Skifte sikringene     |
| NL Zekeringen vervangen    | SE Byte av säkringar     | FI Vaihtaa varokkeet        | PL Wymienić bezpieczniki |
| GB Changing the fuse       |                          |                             |                          |

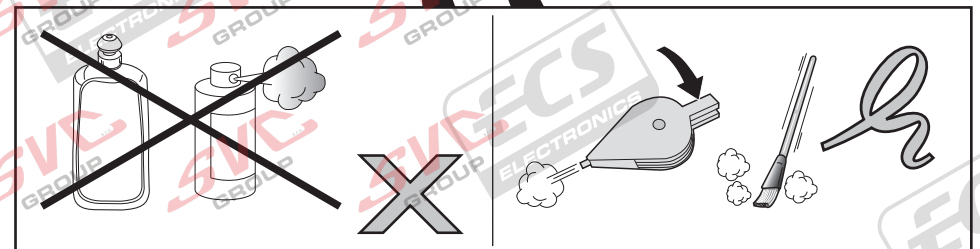
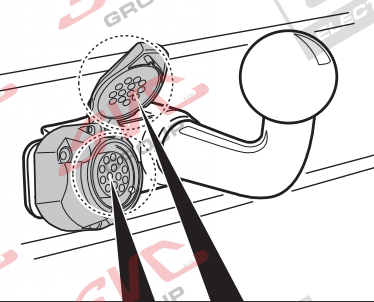
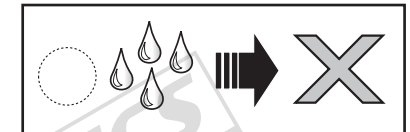
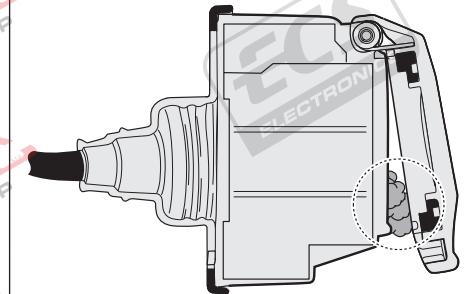
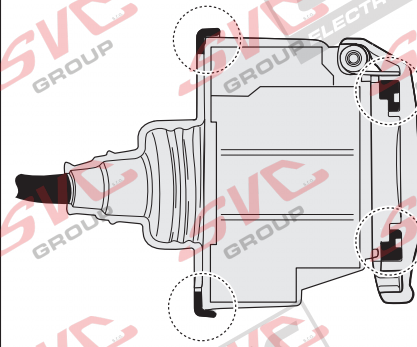
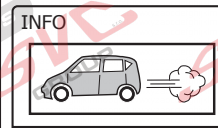
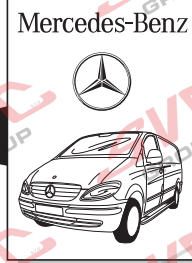
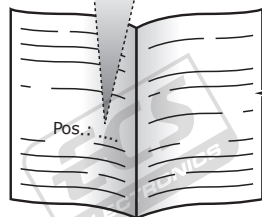
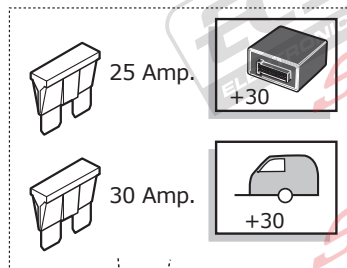

INFO : Ring.

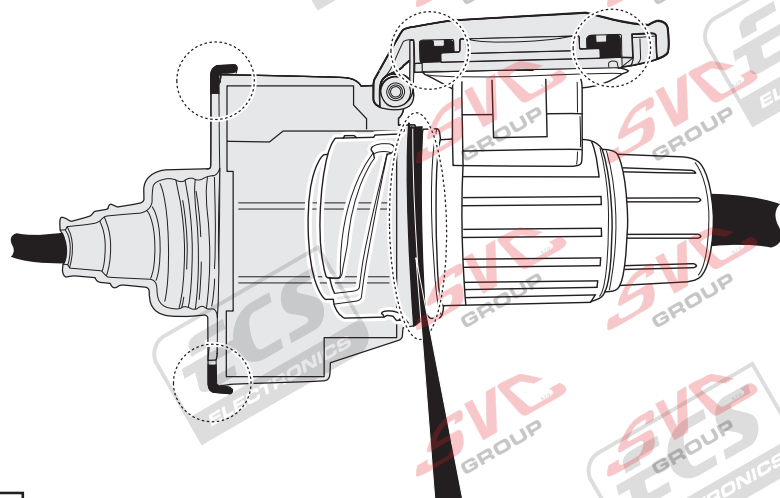
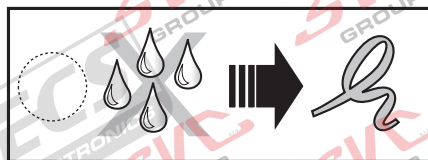
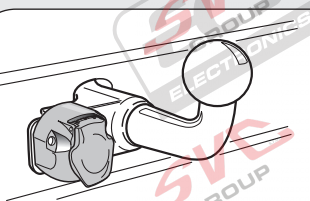
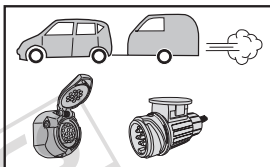

INFO

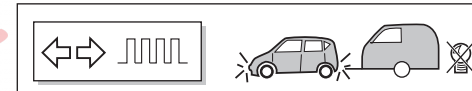
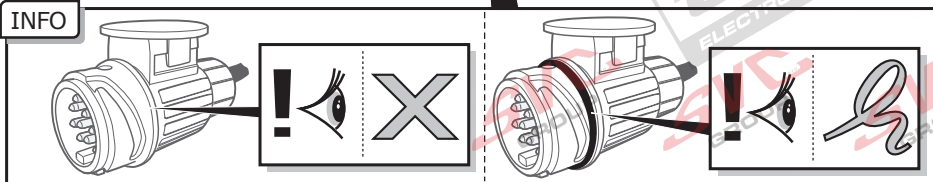

- (DU) Ein defektes Blinklicht an der Anhänger wird durch ein schnelleres Blinken der anderen Blinklichter angezeigt.
- (FR) Un clignotant défectueux de la remorque est signalé par le clignotement plus rapide des autres lampes clignotantes.
- (NL) Een defekt knipperlicht van de aanhanger wordt aangegeven door het versneld knipperen van de overige knipperlichten.
- (GB) A defective indicator of the trailer is stated by a quicker flashing of the other indicator lights.
- (ES) Una luz de destellos defectuosa en vehículos con o sin remolque se indica mediante el parpadeo rápido de las restantes luces de destellos.
- (IT) Un indicatore di direzione difettoso del rimorchio viene indicato dal lampeggiare più rapido degli altri indicatori di direzione.
- (SE) En trasig blinkerlampa anges genom att de övriga blinkljusen blinkar snabbt.
- (CZ) Vadné směrové světlo přívěs je signalizováno rychlejším blikáním dalšího směrového světla.
- (DK) Hvis der findes et defekt indikatorlys i anhængerens vises det ved at det andet indikatorlys blinker hurtigere.
- (FI) Viallisesta vilkkulampusta ilmaistaan siten, että muut vilkkuvalot vilkkuvat nopeammin.
- (GR) Ο ελαττωματικός λαμπτήρας των φλας του αυτοκινήτου ή/και του ρυμουλκού υποδηλώνεται από ένα πιο γρήγορο αναβόσβημα του άλλου λαμπτήρα των φλας.
- (NO) Et defekt blinklys vises ved at de øvrige blinklysene blinker raskt.
- (PL) Uszkodzone światło wskaźnika w przyczepa jest sygnalizowane przez szybsze pulsowanie drugiego wskaźnika.

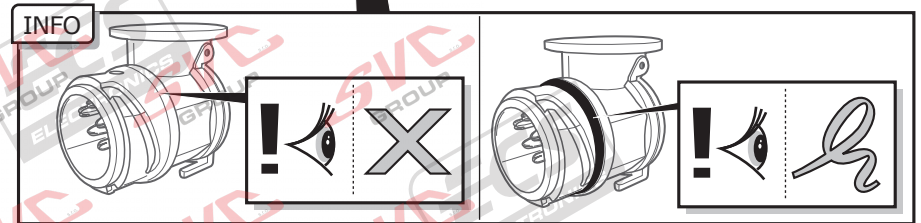
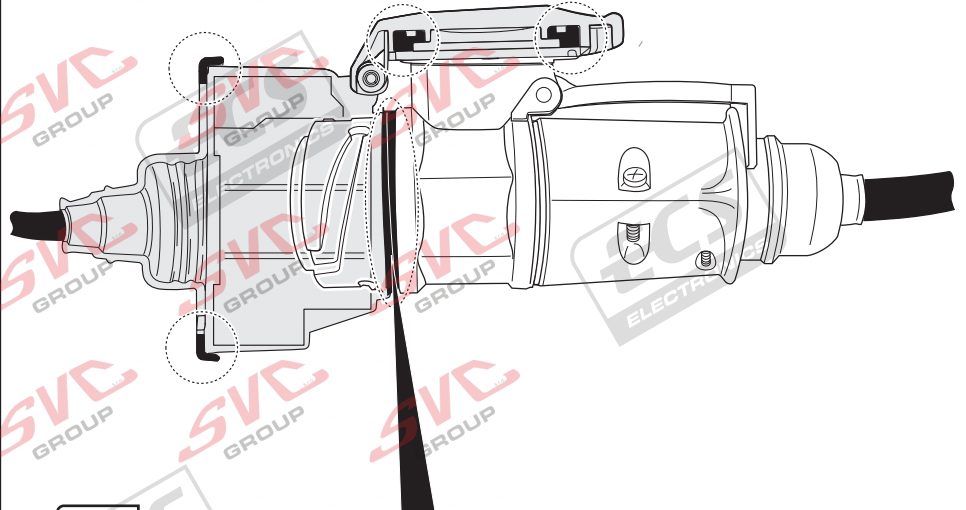
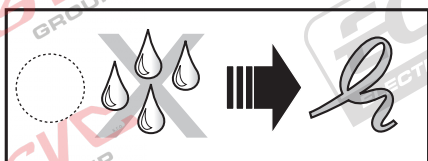
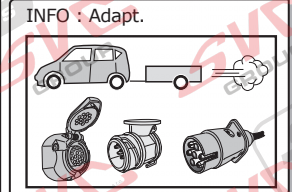
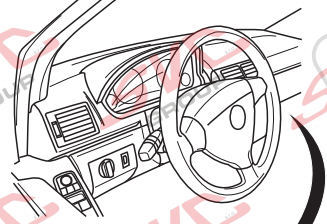
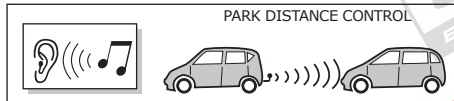

INFO : Storage

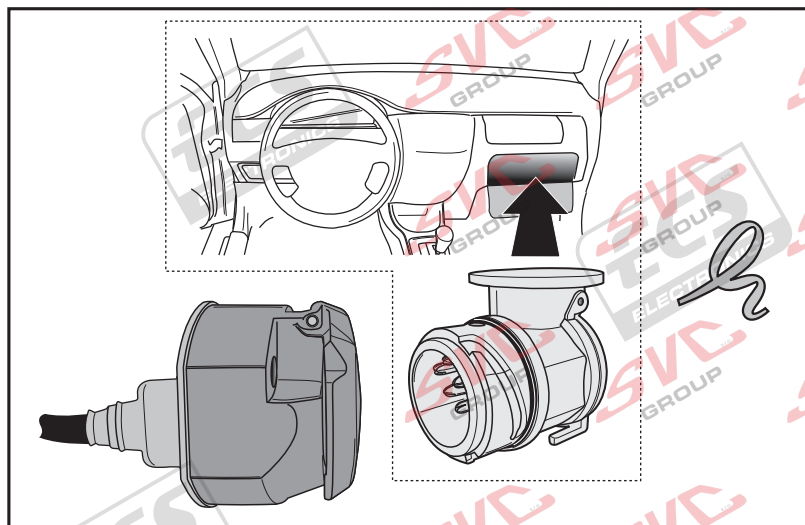
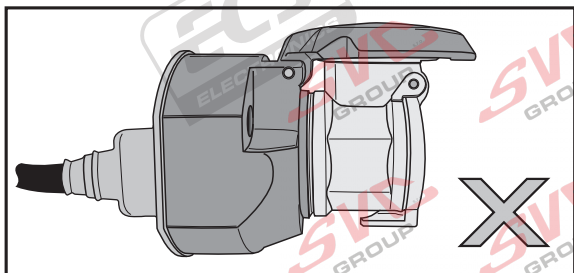
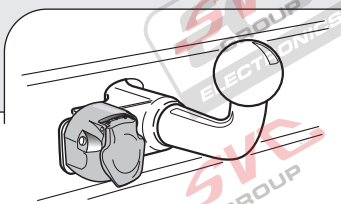
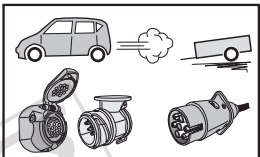

(DE) Falls zutreffend soll bei einem angekoppelten Anhänger mit einer Nebelleuchte in Betrieb die Nebelleuchte des Fahrzeugs ausgeschaltet werden.

(FR) Le cas échéant, lorsqu'une remorque, avec des anti-brouillard actifs, est branchée, les anti-brouillards du véhicule seront déconnectés.

(NL) Indien van toepassing zal bij een gekoppelde aanhanger met een werkende mistlamp de mistlamp van het voertuig worden uitgeschakeld.

(GB) In a coupled trailer with working fog lamp, the fog lamp of the vehicle will be switched off, if applicable.

(ES) En un remolque acoplado con faros antiniebla en funcionamiento, se apagarán, si es aplicable, los faros antiniebla del vehículo.

(IT) Se applicabile, in presenza di un rimorchio agganciato con una luce antinebbia in funzione, l'antinebbia del veicolo viene disinserito.

(SE) Om tillämpligt kopplas ett fungerande dimljus bort från det anslutna släpet.

(CZ) Pokud je na připojeném přívěsu zapnuta mlhovka, bude tato mlhovka na přívěsu vypnuta.

(DK) Hvis det er relevant, vil på en tilkoblet anhænger med en fungerende tågelygte vognens tågelygte frakobles.

(FI) Jos liitetyssä perävaunussa on toimiva sumuvalo, ajoneuvon sumuvalo kytketään pois päältä.

(GR) Σε συζευγμένο ρυμουλκό στο οποίο λειτουργεί φανός ομίχλης, ο φανός ομίχλης του οχήματος θα απενεργοποιηθεί, εφόσον ενδείκνυται.

(NO) Om nødvendig skal kjøretøyets tåkelys slås av, dersom tilhengeren som kobles til selv har et fungerende tåkelys.

(PL) W stosownych przypadkach, przy przyłączonej przyczepie z działającymi światłami przeciwmgielnymi, zostaną wyłączone światła przeciwmgielne pojazdu.