

- ⓁⒹ Gebrauchsanleitung
- ⓁⒻ Mode d'emploi
- ⓁⒸ Gebruikershandleiding
- ⓁⒼ User guide
- ⓁⒺ Guía del usuario
- ⓁⓉ Manuale di istruzioni
- ⓁⒺ Bruksanvisning
- ⓁⒸ Užívateľská príručka
- ⓁⒻ Brugervejledning
- ⓁⒾ Käyttöohjeet
- ⓁⒼ Οδηγός χρήστη
- ⓁⒻ Brukerveiledning
- ⓁⒾ Instrukcja obsługi

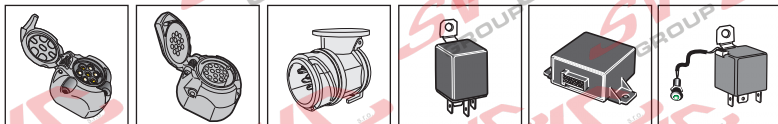

SPARE PARTS

www.ecs-electronics.com



Partnr.: MB-070-D1

Gebrauchsanleitung	ⓁⒹ	ⓁⒸ	Užívateľská príručka
Mode d'emploi	ⓁⒻ	ⓁⒻ	Brugervejledning
Gebruikershandleiding	ⓁⒸ	ⓁⒾ	Käyttöohjeet
User guide	ⓁⒼ	ⓁⒼ	Οδηγός χρήστη
Guía del usuario	ⓁⒺ	ⓁⒻ	Brukerveiledning
Manuale di istruzioni	ⓁⓉ	ⓁⒾ	Instrukcja obsługi
Bruksanvisning	ⓁⒺ		

Mercedes Vito / Viano 08/2005-

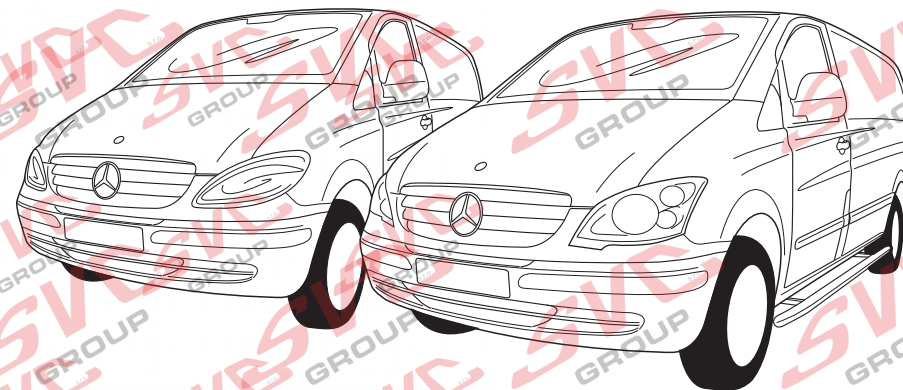
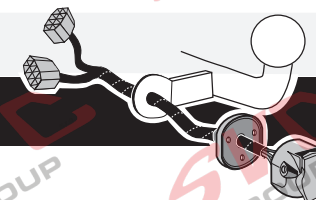

- Anschluss Steckdose
- Connection de la prise
- Contactdoos aansluiting
- Socket connection
- Conexión de la caja de enchufe
- Allaccio zoccolo
- Anslutning kontaktbox
- Objímkový konektor
- Stikkåse forbindelse
- Pistorasias liitäntä
- Υποδοχή σύνδεσης
- Tillkobling koblingsboks
- Połączenie przez gniazdo

DIN/ISO 11446	←		1-8		5/58-R	52W	7/58-L	8	9	10	11	12	13
P.max	1/L 21W	2x21W	4/R 21W	52W	52W	52W	52W	2x21W	180W/15Amp	180W/15Amp	180W/15Amp	180W/15Amp	180W/15Amp
	Gelb	Blau	Grün	Braun	Braun	Schwarz	Schwarz	Schwarz/ Rot	Braun/ Weiß	Rot	Weiß	-	Weiß
	Jaune	Bleu	Vert	Marron	Marron	Noir	Noir	Noir/ Rouge	Marron/ Blanc	Rouge	Blanc	-	Blanc
	Geel	Blauw	Groen	Bruin	Bruin	Zwart	Zwart	Zwart/ Rood	Bruin/ Wit	Rood	Wit	-	Wit
	Yellow	Blue	Green	Brown	Brown	Black	Black	Black/ Red	Brown/ White	Red	White	-	White
	Amarillo	Azul	Verde	Marrón	Marrón	Negro	Negro	Negro/ Rojo	Marrón/ Blanco	Rojo	Blanco	-	Blanco
	Giallo	Blu	Verde	Marrone	Marrone	Nero	Nero	Rosso	Marrone/ Bianco	Rosso	Bianco	-	Bianco
	Gul	Blå	Grön	Brun	Brun	Svart	Svart	Svart/ Röd	Brun/ Vit	Röd	Vit	-	Vit
	Žlutá	Modrá	Zelená	Hnědá	Hnědá	Černá	Černá	Černo/ Červená	Hnědo/ Bílá	Červená	Bílá	-	Bílá
	Gul	Blå	Grøn	Brun	Brun	Sort	Sort	Sort/ Rød	Brun/ Hvid	Rød	Hvid	-	Hvid
	Keltainen	Sininen	Vihreä	Ruskea	Ruskea	Musta	Musta	Musta/ Punainen	Ruskea/ Valkoinen	Punainen	Valkoinen	-	Valkoinen
	Κίτρινο	Μπλε	Πράσινο	Καφέ	Καφέ	Μαύο	Μαύο	Μαύο/ Κόκκινο	Καφέ/ Λευκό	Κόκκινο	Λευκό	-	Λευκό
	Gul	Blå	Grønn	Brun	Brun	Svart	Svart	Svart/ Rød	Brun/ Hvit	Rød	Hvit	-	Hvit
	Żółty	Niebieski	Zielony	Brązowy	Brązowy	Czarny	Czarny	Czarny/ Czerwony	Brązowy/ Biały	Czerwony	Biały	-	Biały

- | | | | |
|----------------------------|--------------------------|-----------------------------|--------------------------|
| DE Sicherungen austauschen | ES Cambio de fusible | CZ Výměna pojistky | GR Αλλαγή ασφάλειας |
| FR Remplacer les fusibles | IT Sostituire i fusibili | DK Udskiftning af sikringer | NO Skifte sikringene |
| NL Zekeringen vervangen | SE Byte av säkringar | FI Vaihtaa varokkeet | PL Wymienić bezpieczniki |
| GB Changing the fuse | | | |

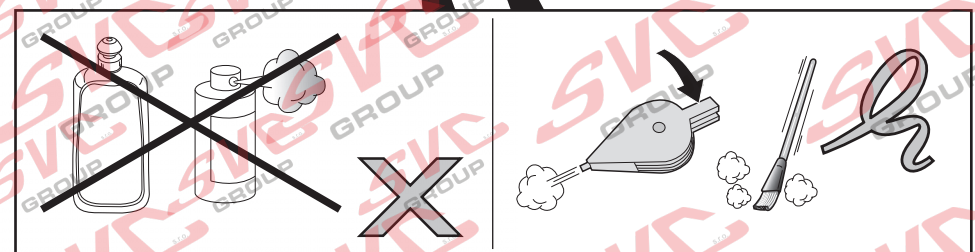
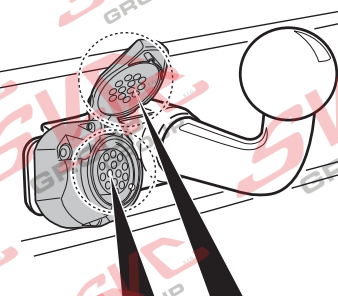
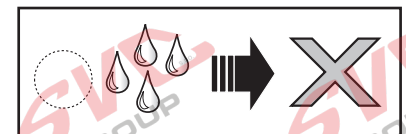
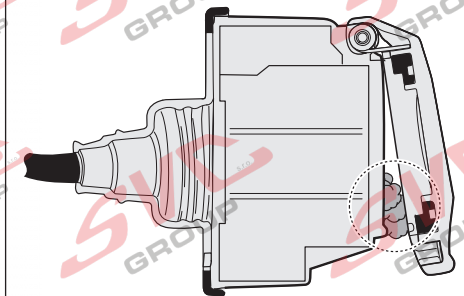
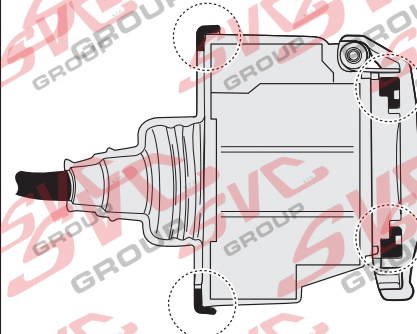
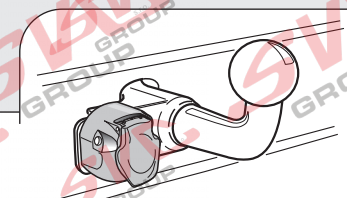
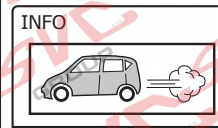
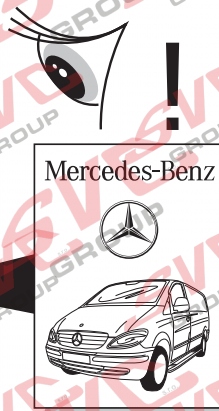
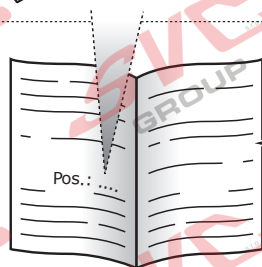
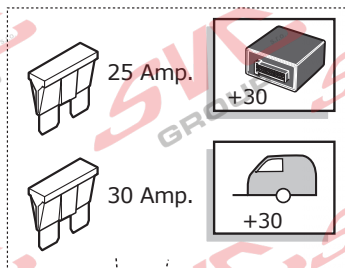

INFO : Ring.

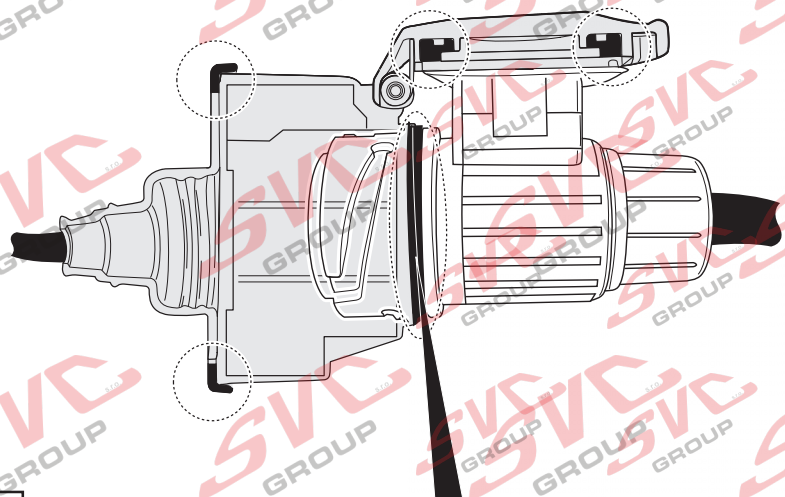
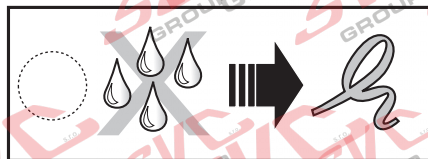
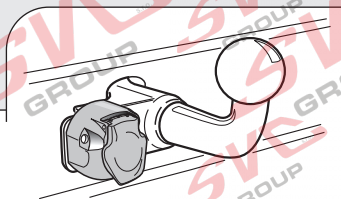
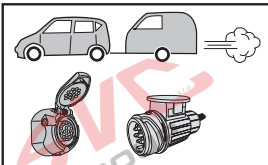

INFO

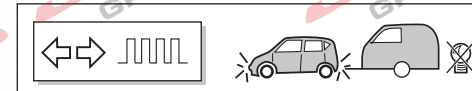
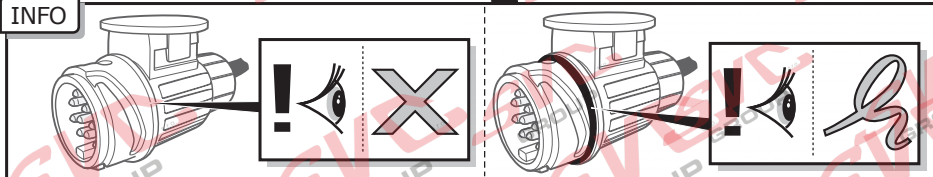

- (DU) Ein defektes Blinklicht an der Anhänger wird durch ein schnelleres Blinken der anderen Blinklichter angezeigt.
- (FR) Un clignotant défectueux de la remorque est signalé par le clignotement plus rapide des autres lampes clignotantes.
- (NL) Een defekt knipperlicht van de aanhanger wordt aangegeven door het versneld knipperen van de overige knipperlichten.
- (GB) A defective indicator of the trailer is stated by a quicker flashing of the other indicator lights.
- (ES) Una luz de destellos defectuosa en vehículos con o sin remolque se indica mediante el parpadeo rápido de las restantes luces de destellos.
- (IT) Un indicatore di direzione difettoso del rimorchio viene indicato dal lampeggiare più rapido degli altri indicatori di direzione.
- (SE) En trasig blinkerlampa anges genom att de övriga blinkljusen blinkar snabbt.
- (CZ) Vadné směrové světlo přívěs je signalizováno rychlejším blikáním dalšího směrového světla.
- (DK) Hvis der findes et defekt indikatorlys i anhængerens vises det ved at det andet indikatorlys blinker hurtigere.
- (FI) Viallisesta vilkkulampusta ilmaistaan siten, että muut vilkkuvalot vilkkuvat nopeammin.
- (GR) Ο ελαττωματικός λαμπτήρας των φλας του αυτοκινήτου ή/και του ρυμουκκού υποδηλώνεται από ένα πιο γρήγορο αναβόσβημα του άλλου λαμπτήρα των φλας.
- (NO) Et defekt blinklys vises ved at de øvrige blinklysene blinker raskt.
- (PL) Uszkodzone światło wskaźnika w przyczepa jest sygnalizowane przez szybsze pulsowanie drugiego wskaźnika.

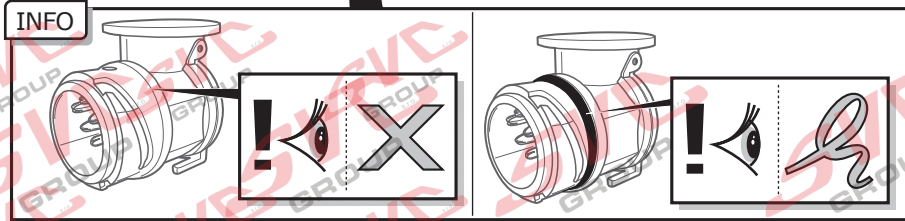
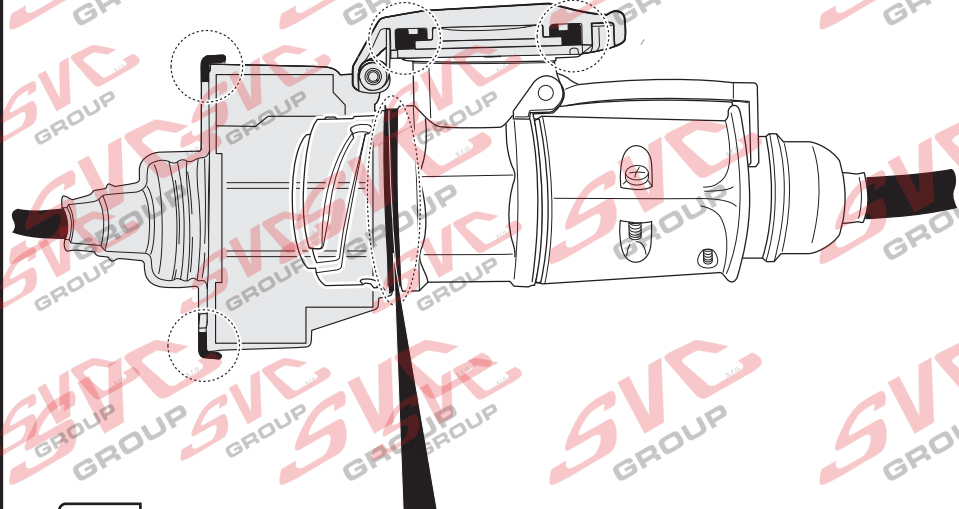
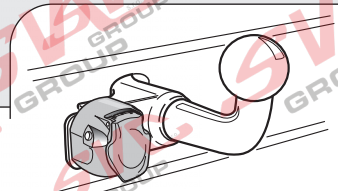
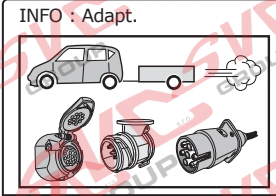
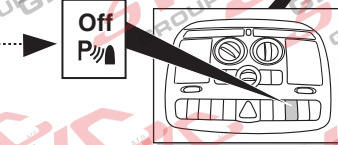
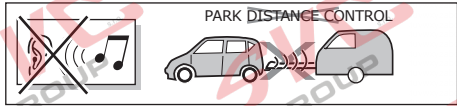

INFO : Storage

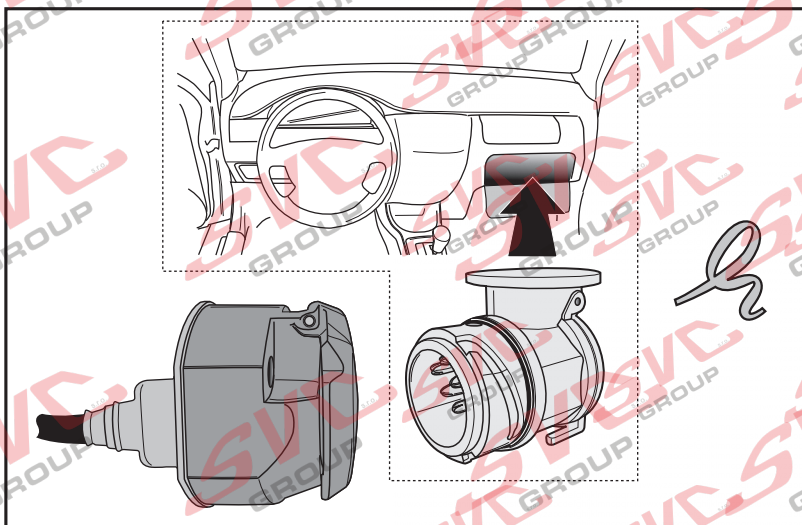
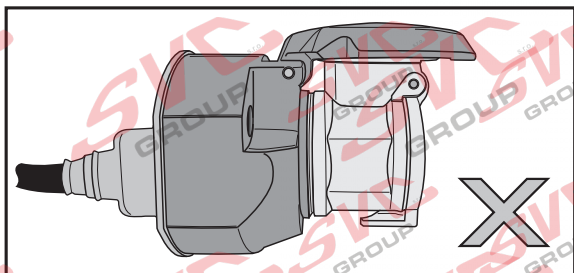
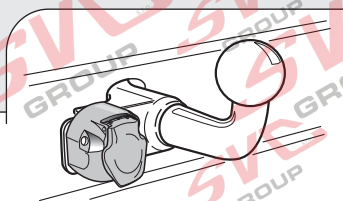
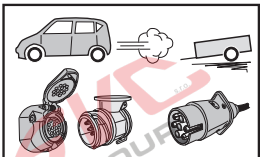

- (DE) Falls zutreffend soll bei einem angekoppelten Anhänger mit einer Nebelleuchte in Betrieb die Nebelleuchte des Fahrzeugs ausgeschaltet werden.
- (FR) Le cas échéant, lorsqu'une remorque, avec des anti-brouillard actifs, est branchée, les anti-brouillards du véhicule seront déconnectés.
- (NL) Indien van toepassing zal bij een gekoppelde aanhanger met een werkende mistlamp de mistlamp van het voertuig worden uitgeschakeld.
- (GB) In a coupled trailer with working fog lamp, the fog lamp of the vehicle will be switched off, if applicable.
- (ES) En un remolque acoplado con faros antiniebla en funcionamiento, se apagarán, si es aplicable, los faros antiniebla del vehículo.
- (IT) Se applicabile, in presenza di un rimorchio agganciato con una luce antinebbia in funzione, l'antinebbia del veicolo viene disinserito.
- (SE) Om tillämpligt kopplas ett fungerande dimljus bort från det anslutna släpet.
- (CZ) Pokud je na připojeném přívěsu zapnuta mlhovka, bude tato mlhovka na přívěsu vypnuta.
- (DK) Hvis det er relevant, vil på en tilkoblet anhænger med en fungerende tågelygte vognens tågelygte frakobles.
- (FI) Jos liitetyssä perävaunussa on toimiva sumuvalo, ajoneuvon sumuvalo kytketään pois päältä.
- (GR) Σε συζευγμένο ρυμουλκό στο οποίο λειτουργεί φανός ομίχλης, ο φανός ομίχλης του οχήματος θα απενεργοποιηθεί, εφόσον ενδείκνυται.
- (NO) Om nødvendig skal kjøretøyets tåkelys slås av, dersom tilhengeren som kobles til selv har et fungerende tåkelys.
- (PL) W stosownych przypadkach, przy przyłączonej przyczepie z działającymi światłami przeciwmgielnymi, zostaną wyłączone światła przeciwmgielne pojazdu.