

# Tažné zařízení Ford Tourneo Courier + Connect.

SK - Ťažné zariadenie GB - Towbars PL - Haki holownicze DE - Anhängervorrichtungen FR - Atelages SPA - Ganchos  
HUN - Vonohorgok RUS/FIN/LIT - Фаркопы RO - Cârlig de remorcare



TYP V TZ 001-510 V TZ 002-510 V TZ 003-510

www.svcgroup.cz



SVC GROUP s.r.o.  
Průmyslová zóna 179  
547 01 Náchod  
Česká republika

FORD Tourneo Courier 02/2022-  
FORD Tourneo Connect 02/2022-



- ✓ ACTIVE, TITANIUM, SPORT + Dodávka VAN
- ✓ Prosklená verze Kombi
- ✓ Krátká + Dlouhá verze Grand + 7 míst

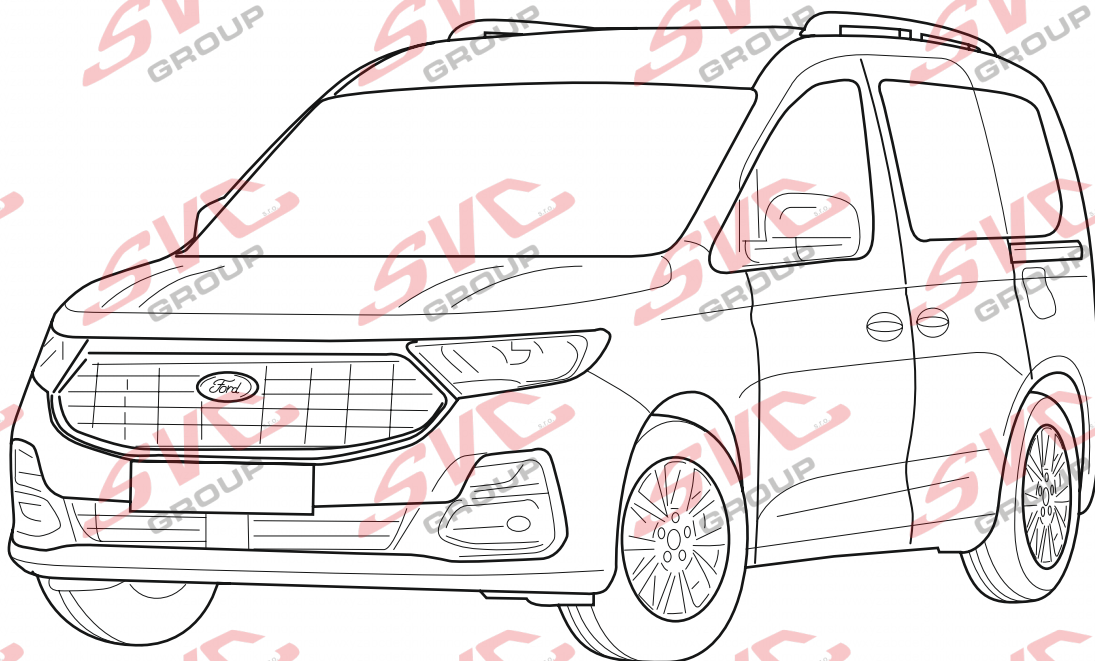

CZ Pro podrobné montážní instrukce a podmínky výrobku si naskenujte QR kód  
SK Pre podrobné montážne pokyny a podmienky produktu si môžete skenovať QR kód  
GB For detailed installation instructions and product conditions, scan the QR code  
DE Scannen Sie den QR-Code, um detaillierte Installationsanweisungen und Produktbedingungen zu erhalten  
FR Pour des instructions d'installation détaillées et les conditions du produit, scannez le code QR  
ITA Per istruzioni di installazione dettagliate e condizioni del prodotto, eseguire la scansione del codice QR  
PL Aby uzyskać szczegółowe instrukcje dotyczące instalacji i warunki produktu, zeskanuj kod QR  
SP Para obtener instrucciones detalladas de instalación y condiciones del producto, escanee el código QR  
NL Voor gedetailleerde installatie-instructies en productvoorwaarden, scan de QR-code  
FIN Tarkemmat asennusohjeet ja tuotteen ehdot on tarkistettava QR-koodilla  
HU A részletes telepítési utasítások és a termék feltételei között olvassa el a QR kódot  
SLO Za podrobna navodila za namestitvev in pogoje izdelka skenirajte kodo QR  
RU Подробные инструкции по установке и условиям продукта отсканируйте QR-код.

SVC GROUP ©-11/19

e-mail: scv@scvgroup.cz Tel.: +420 491421021 +420 491421022 mob.: +420 603360607



FORD Tourneo Courier 2022-  
 FORD Tourneo Connect 2022-



2022-  
 2022-



VTZ 001-510

19,70



A-510-2021



VTZ 002-510

20,70



V-510-2021



VTZ 003-510

21,70



AV-510-2021



08/



1 650/100 D=9,26



55R-01-0549.1



1,5->2,0 h



2->2,5 h

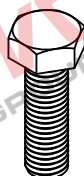
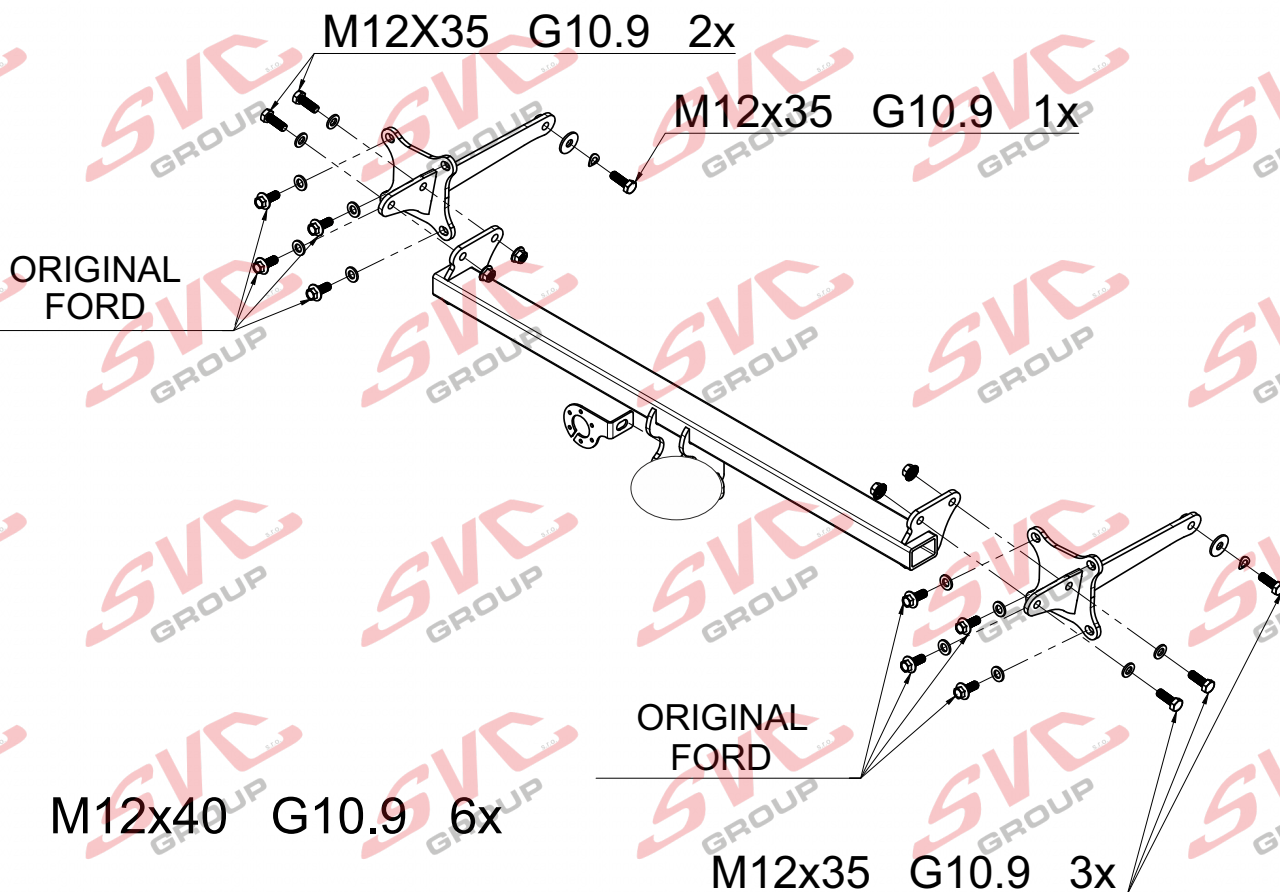

M12x40 G10.9 6x



Ø12

2x



Ø12

4x



Ø12

2x



M12

4x



2x

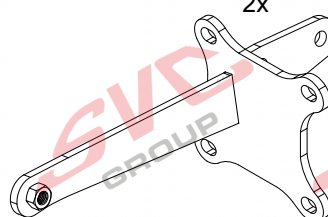





# FORD Tourneo Courier 2022- FORD Tourneo Connect 2022-



**VTZ 001-510**



**VTZ 002-510**



**VTZ 003-510**

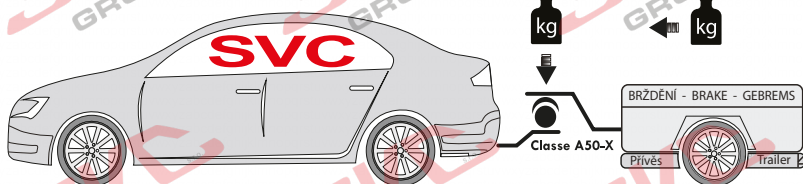

**M12X35 G10.9 2x**

**M12x35 G10.9 1x**

ORIGINAL FORD

ORIGINAL FORD

**M12x35 G10.9 3x**

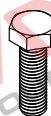

**M12x40 G10.9 6x**



**Ø12 2x**



**Ø12 4x**



**Ø12 2x**



**M12 4x**

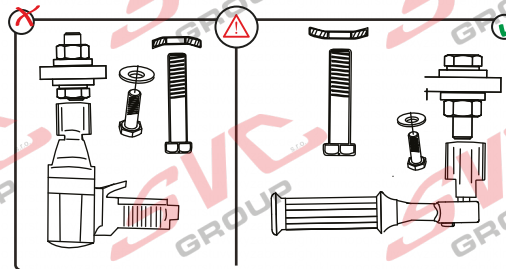
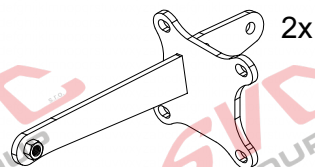

**Nm**

Pevnost	8,8	10,9	12,9
M6	9,7	14,3	16,1
M8	24,5	35,9	42,0
M10	48,4	71,0	83,0
M12	84,0	123,0	144,0
M14	133,0	196,0	229,0
M16	137,0	307,0	359,0



**Nm**



Homologace EHK 55-R

**55R-01-0549**

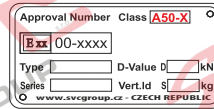

- CZ** Informace k provozu / homologaci
- SK** Informácie na prevádzku / homologáciu
- EN** Operating / homologation information
- DE** Betriebs- / Zulassungsinformationen
- HU** Üzemeltetési / homologációs információk
- FR** Informations d'exploitation / homologatio
- IT** Informazioni sull'operazione / omologazio
- NL** Monteringsanvisningar
- ES** Instrucciones de montaje
- FIN** Montage-instructie
- SV** Asennusohjeet
- NOR** Drifts- / homologasjonsinformasjon
- PL** Informacje dotyczące pracy / homologacji
- RU** Информация о работе / омологации



**SVC GROUP s.r.o.** Průmyslová zóna - 179 547 01 Náchod-ČR

[www.svcgroup.cz](http://www.svcgroup.cz)  
e-mail: [svc@svcgroup.cz](mailto:svc@svcgroup.cz)

Tel.: +420 491 421 021  
+420 491 421 022  
mob.: +420 603 360 607

QR kódem si stáhnete si rozšířeny montážní návod / Mit QR-Code können Sie die erweiterte Montageanleitung herunterladen

SVC GROUP ©- 05/19



### CS Montážní návod

1. Odmontujte zadní nárazník a rezervní kolo. Odmontujte výztuhu nárazníku (nebude již zapotřebí). Originální šrouby uschovejte k montáži tažného zařízení.
2. Do nosníků namontujte levý a pravý bok tažného zařízení dle obrázku. Použijte originální šrouby od výztuhy. Namontujte hlavní nosník tažného zařízení 4 šrouby M12x35(10.9).
3. Tažné zařízení vyrovnejte a dotáhněte dle utahovacích momentů. Poté namontujte zpět všechny díly odmontované v bodě č.1.

### SK Montážny návod

1. Od zadní nárazník a rezervní kolo Od teraz výztuhu nárazníku (nebude už nutný). Originálne skrutky uschovejte k montáži ťažkého zariadenia.2. Do nosníkov na skvelý levý a pravý bok ťažkého zariadenia dle obrázku. Použite originálne skrutky od výztuhy. Na základe hlavného nosníka ťažného zariadenia 4 skrutky M12x35(10.9).3. Ťažné zariadenie vyrovnejte a stiahnite podľa utahovacích momentov. Poté na zpět zpět všechny díly odmontované v bodě č.1.

### EN Installation instructions

1. Remove rear bumper and spare wheel. Remove the bumper stiffener (it is no longer needed). Keep the original screws to be used for the installation of the tow bar.
2. Mount left and right sides of the tow bar into the beams as shown in the picture. Use the original screws of the stiffener. With using of four M12x35 screws (10.9) install main beam of the tow bar.
3. Align all the parts of the tow bar and tighten them to prescribed torques. Then reinstall all the parts removed within the step 1.

### DE Montageanleitung

1. Die Stoßstange und das Reserverad ausbauen. Die Strebe der Stoßstange ausbauen (sie wird nicht mehr nötig sein). Die originellen Schrauben für nachfolgende Montage der Zugeinrichtung aufbewahren.
2. Die linke und rechte Seite der Zugeinrichtung in die Träger montieren, s. Abbildung. Die originellen Schrauben der Strebe verwenden. Den Hauptträger der Zugeinrichtung mit 4 Schrauben M12 x 35 (10.9) montieren.
3. Die Zugeinrichtung ausrichten und mit entsprechenden Drehmomenten festziehen. Dann alle im Punkt Nr. 1 ausgebauten Teile wieder einbauen.

### IT Istruzioni di montaggio

1. Smontare il paraurti posteriore e la ruota di scorta. Smontare il rinforzo del paraurti (non sarà più necessario). Conservare i bulloni originali per poter montare il dispositivo di traino.
2. Montare il fianco sinistro e destro del dispositivo di traino nei supporti, vedi figura. Usare i bulloni originali del rinforzo. Montare il supporto principale del dispositivo di traino usando 4 bulloni M12x35 (10.9).
3. Allineare il dispositivo di traino e serrare con le coppie di serraggio prescritte. Quindi rimontare tutti i componenti smontati nel punto 1.

### FR Notice d'assemblage

1. Déposer le pare-chocs arrière ainsi que la roue de secours. Déposer le renfort du pare-chocs (ne sera plus nécessaire). Conserver les vis d'origine pour la pose du dispositif d'attelage.
2. Monter le flanc droit et gauche du dispositif de d'attelage sur les longerons selon la figure. Utiliser les vis et les renforts d'origine. Monter le longeron principal du dispositif d'attelage 4 vis M12x35(10.9).
3. Égaliser le dispositif d'attelage et serrer aux couples préconisés. Reposer ensuite toutes les pièces déposées au point n°1.







1.

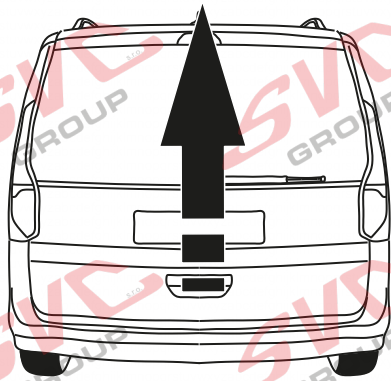

Montážní návod  
Montážny návod  
Installation instructions  
Installationsanleitung  
Instructions d'installation  
Инструкция по установке



2.

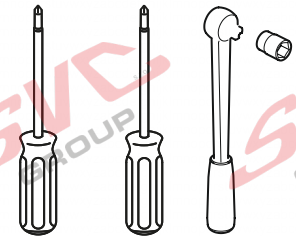
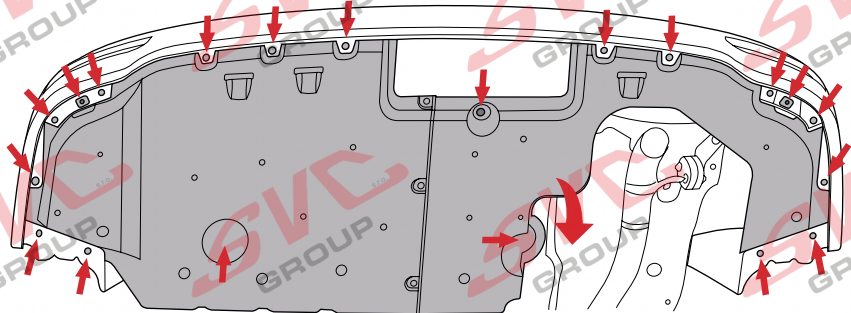
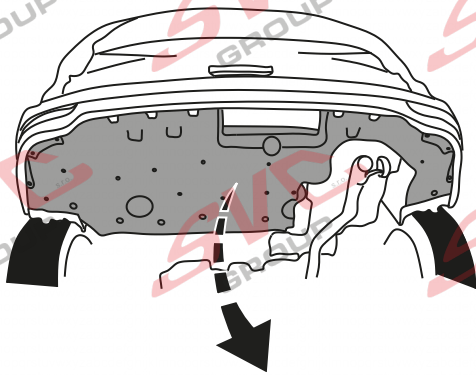

T15 T25 10



3.

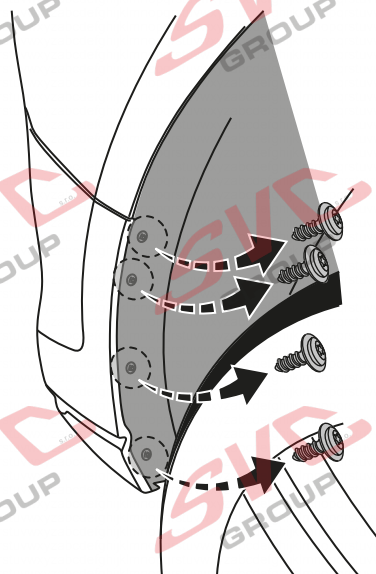
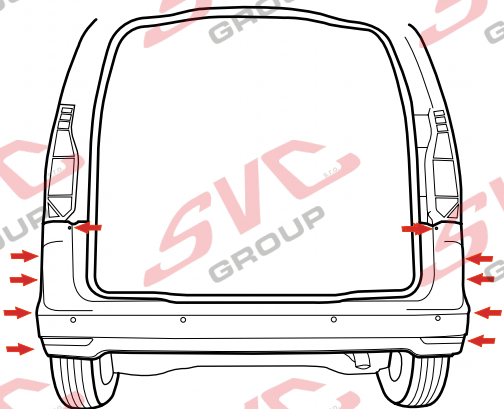

T25

SVC GROUP O



SVC GROUP s.r.o.

Průmyslová zóna - 179  
547 01 Náchod-ČR

www.svcgroup.cz  
e-mail: svc@svcgroup.cz

Tel.: +420 491421021  
+420 491421022  
mob.: +420 603360607

QR kódem stáhnete rozšířeny montážní návod / Met QR-code kunt u de uitgebreide montage-instructies downloaden

SVC GROUP © - 05/19

4.

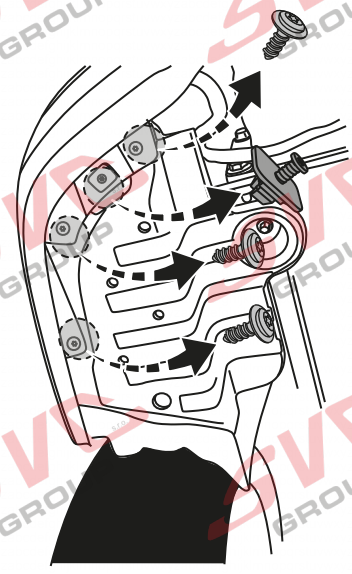
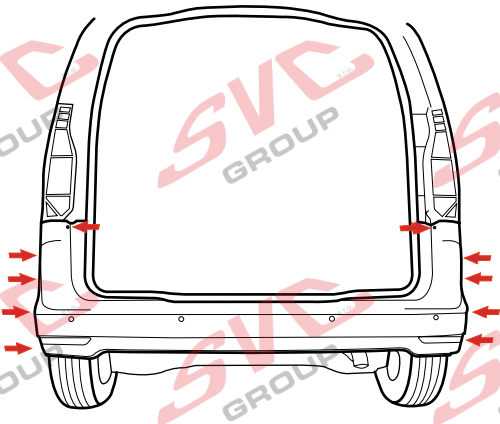

T15

T25

10

5.

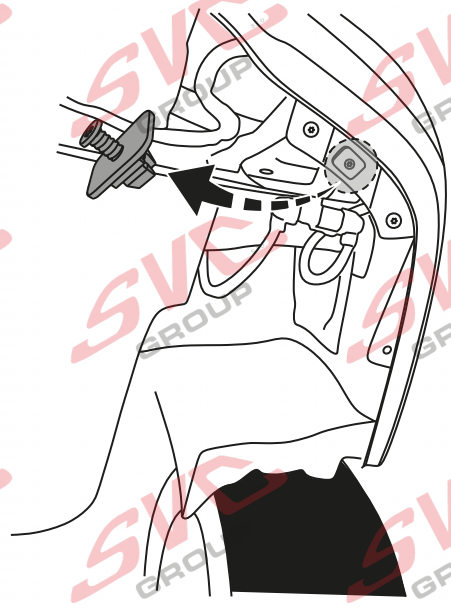

6.

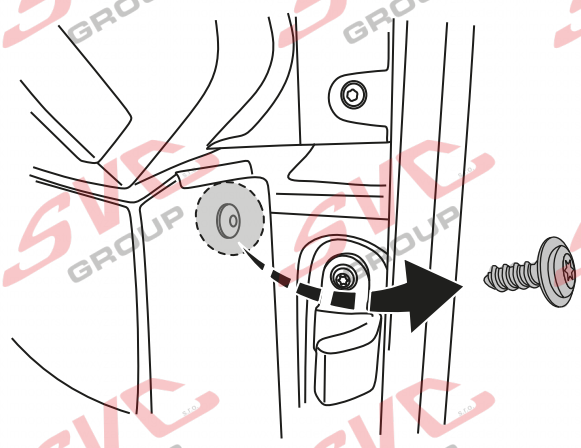



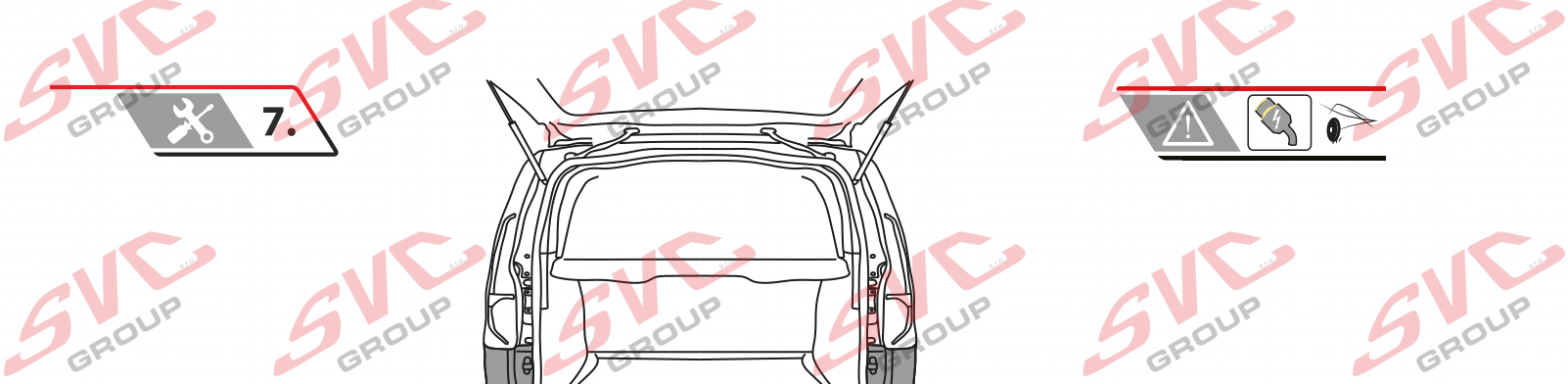

7.

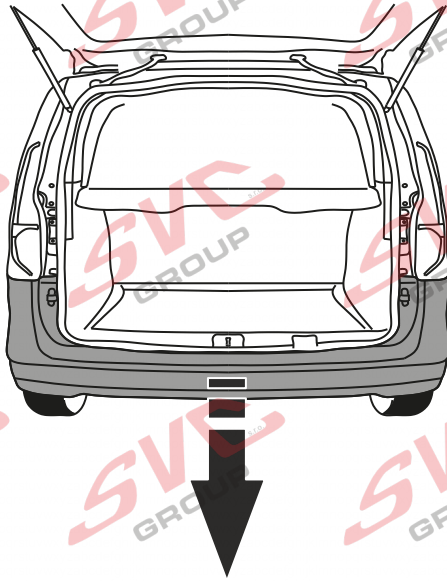

8.

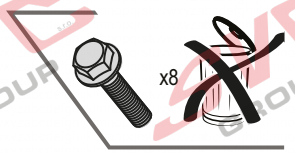
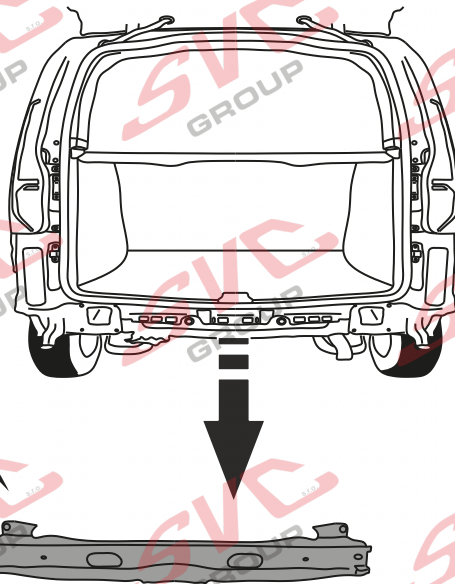
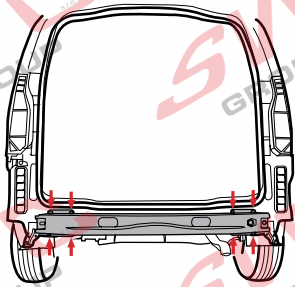

x8

16



9.

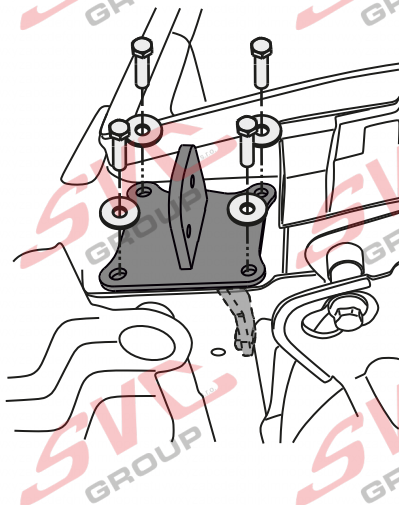
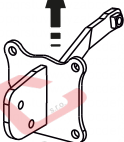
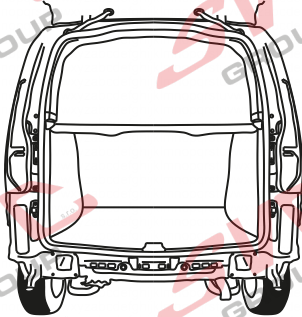

M10x40 x4



Ø10 x4

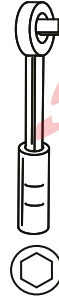

16



SVC GROUP s.r.o. Průmyslová zóna - 179 547 01 Náchod-ČR

www.svcgroup.cz e-mail: svc@svcgroup.cz

Tel.: +420 491421021 +420 491421022 mob.: +420 603360607

QR kódem stáhnete rozšířený montážní návod / QR kódem stáhnete rozšířený montážní návod

SVC GROUP ©- 05/19

  10.

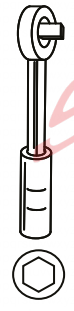
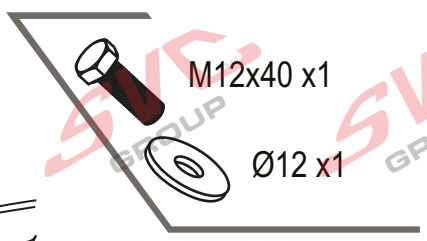
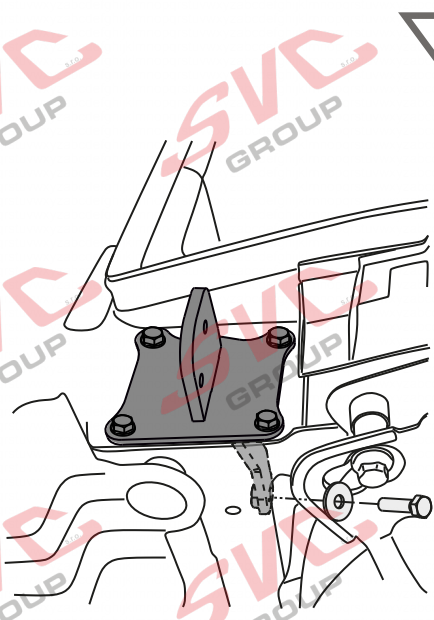
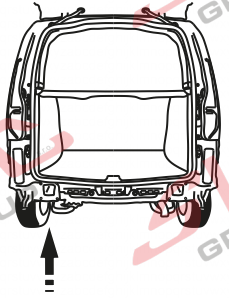

18

  11.

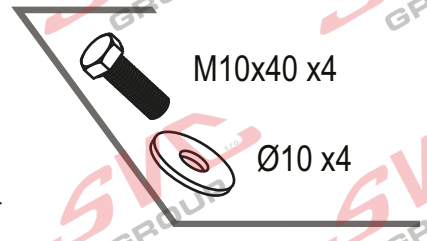
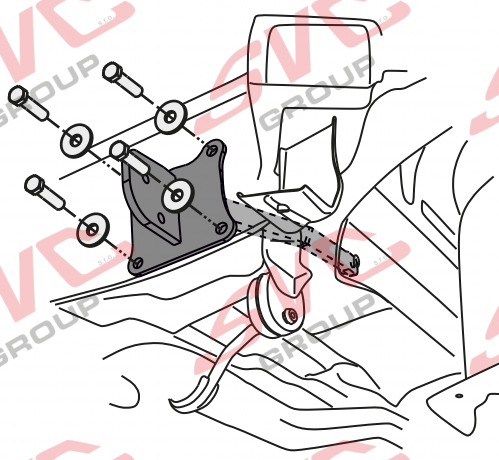
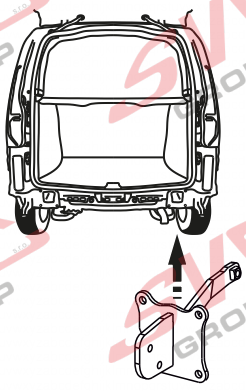

16

  12.

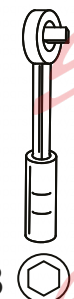
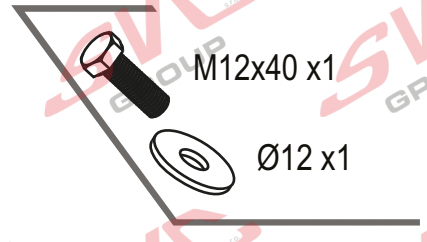
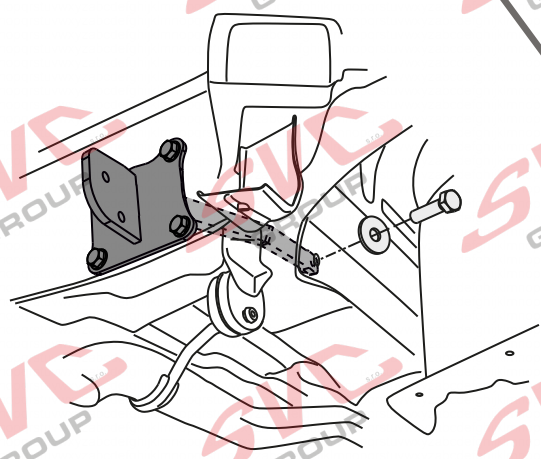
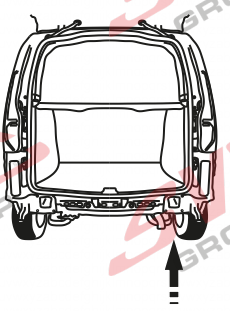

18





13.

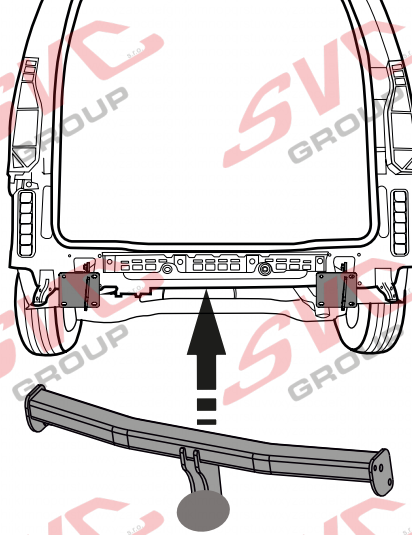
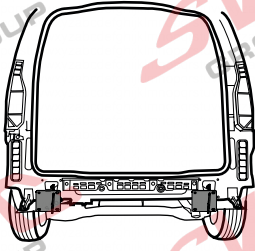
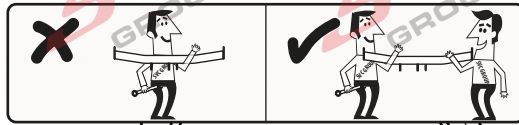

14.

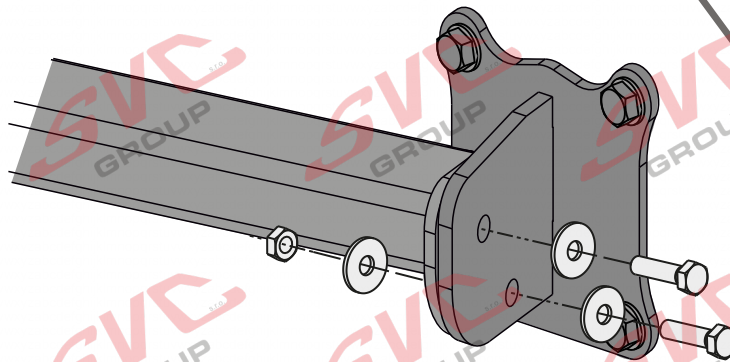
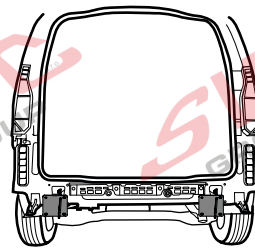

- M12x40 x4
- Ø12 x6
- M12 x2

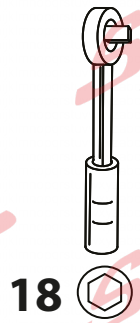

15.

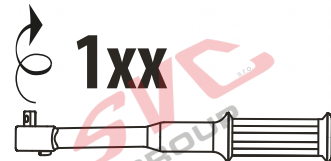
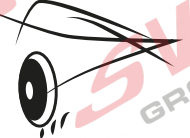
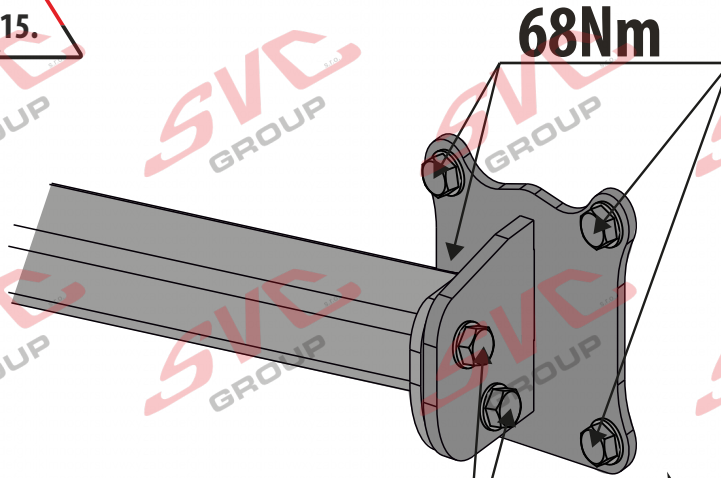
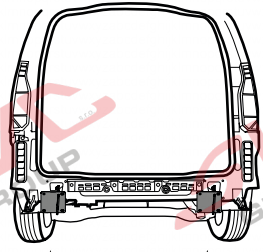

16  
18  
Nm



16.

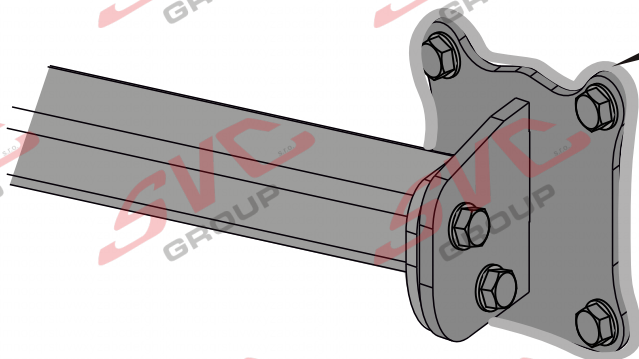
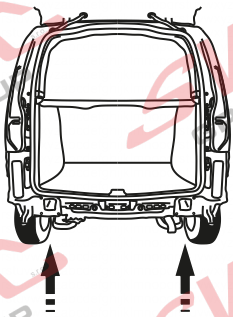

17.

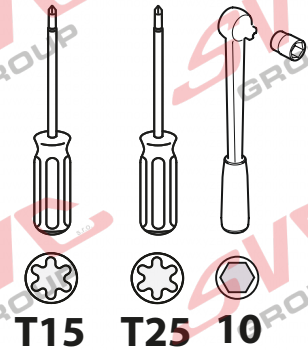
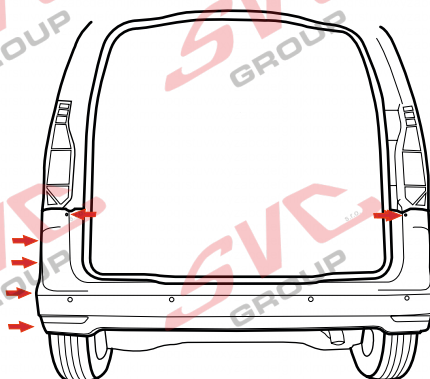
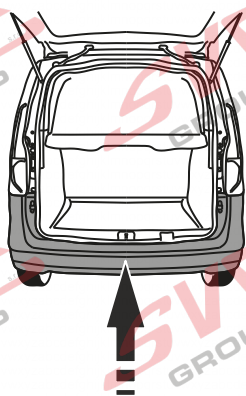
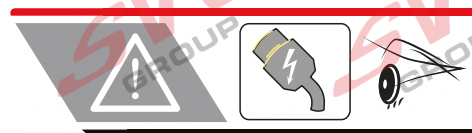
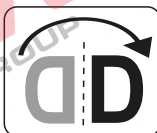

18.

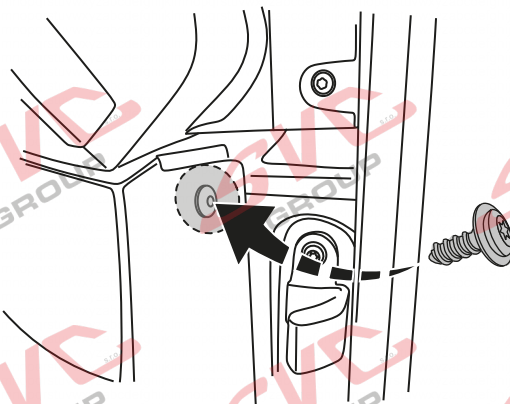



19.

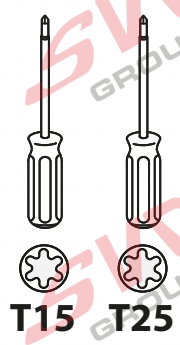
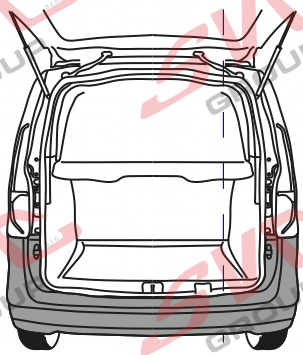

20.

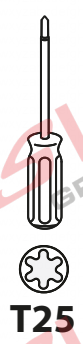
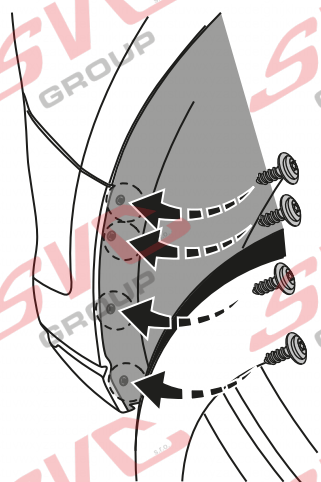
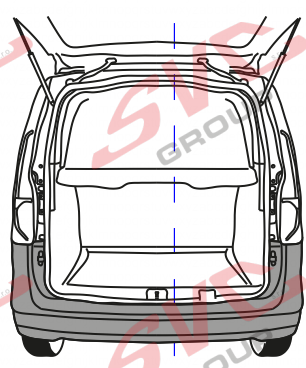

21.

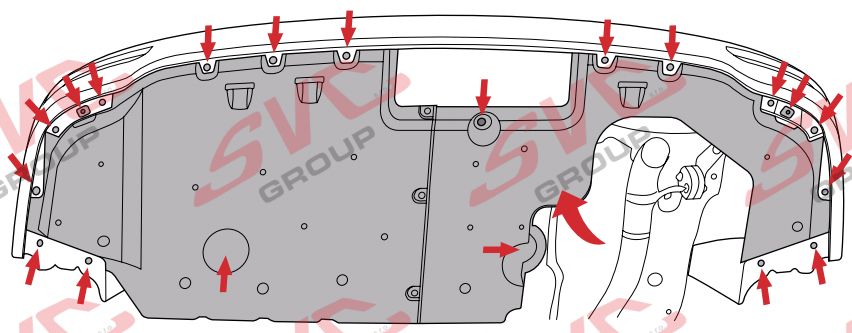
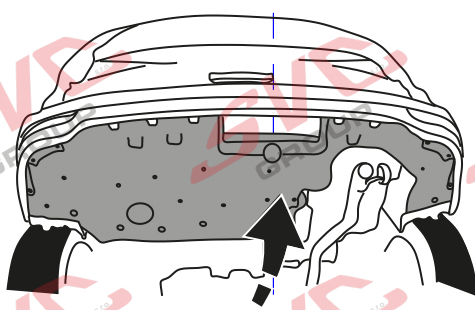

SVC GROUP s.r.o. Průmyslová zóna - 179 547 01 Náchod-ČR

www.svcgroup.cz e-mail: svc@svcgroup.cz

Tel.: +420 491421021 +420 491421022 mob.: +420 603360607

QR kódem stáhnete rozšířený montážní návod / لينز نزلت الموسعة في عيسرلا ةباجتسلازم / ز ارمع لا تاميلعت SVC GROUP ©- 05/19

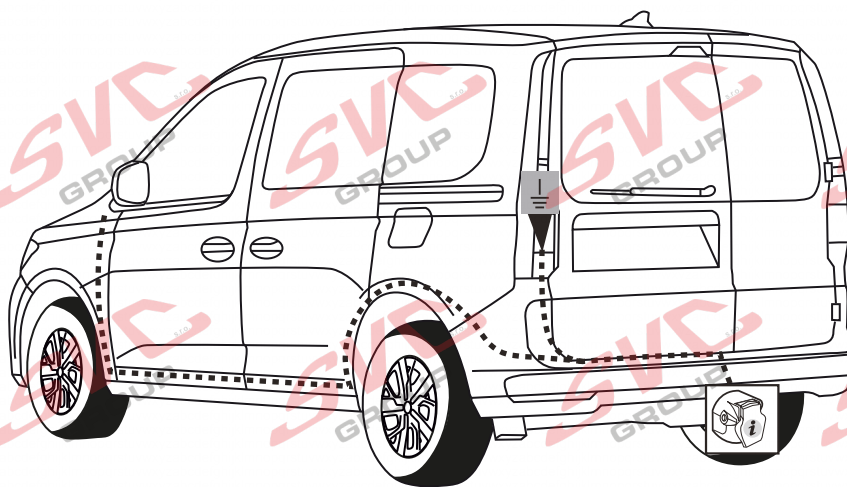
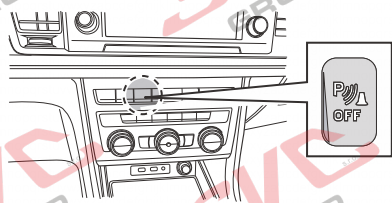
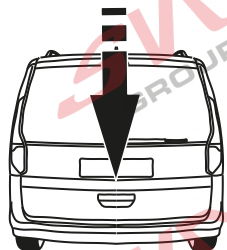

Informace pro odpojování couvacích senzorů PDC pro tažné zařízení

Vypínač pro vypínání couvacích senzorů PDC je umístěn na palubní desce vozu.

Nemusíte tedy pracně na elektro instalaci vozu napojovat odpojování couvacích senzorů PDC a zpětných kamer od elektro přípojky tažných zařízení.

Pokud chcete senzory vypnout, použijte vypínač na palubní desce.

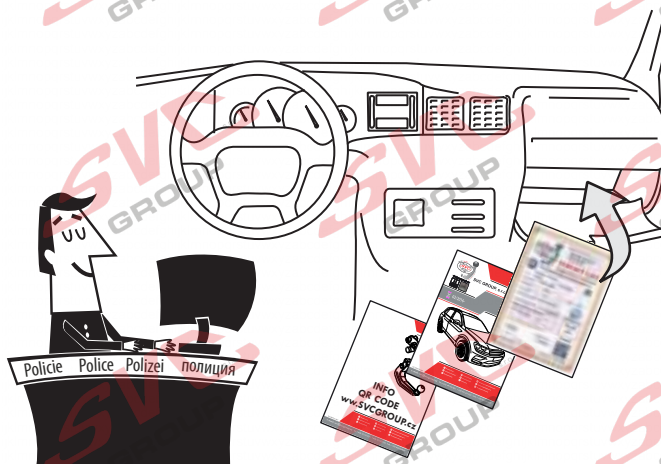
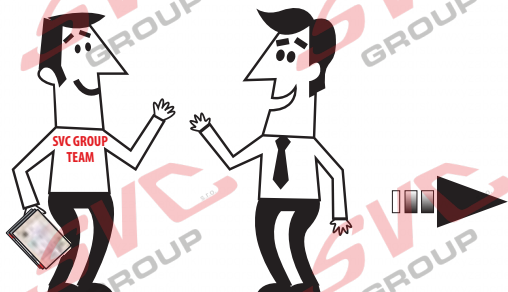

## SVC GROUP

Děkuje za důvěru / Ďakuje za dôveru

Thank you for your trust / Danke Für dein Vertrauen

Merci pour votre conance / Grazie per la tua ducia

Tankewol foar jo fertrouwen / Спасибо за ваше доверие

Registrace / Registrácia

Registration / Registrierung

Inscription / Registrazione

Rekisteröinti / Регистрация

