



CZ - Tažné zařízení / SK - Ťažné zariadenie / GB - Towbars / PL - Haki holownicze
 DE - Anhängervorrichtungen / FR - Attelages / SPA - Ganchos / HUN - Vonohorgok
 RUS/FIN/LIT - Фаркопы / RO - Cârlig de remorcare

VTZ 1.001-503

VTZ002-503

VTZ 1,003-503



www.svcgroup.cz



SVC GROUP s.r.o
 Průmyslová zóna 179
 547 01 Náchod
 Česká Republika

Toyota Corolla HB

(E21)



01/2019 ->



1->2,0 h



2->2,5 h

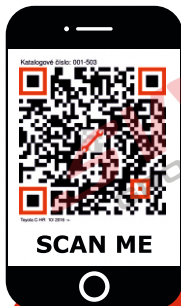
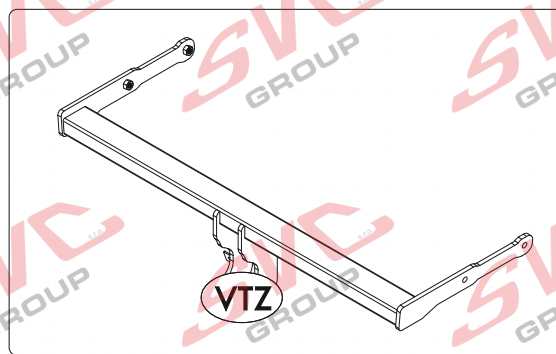
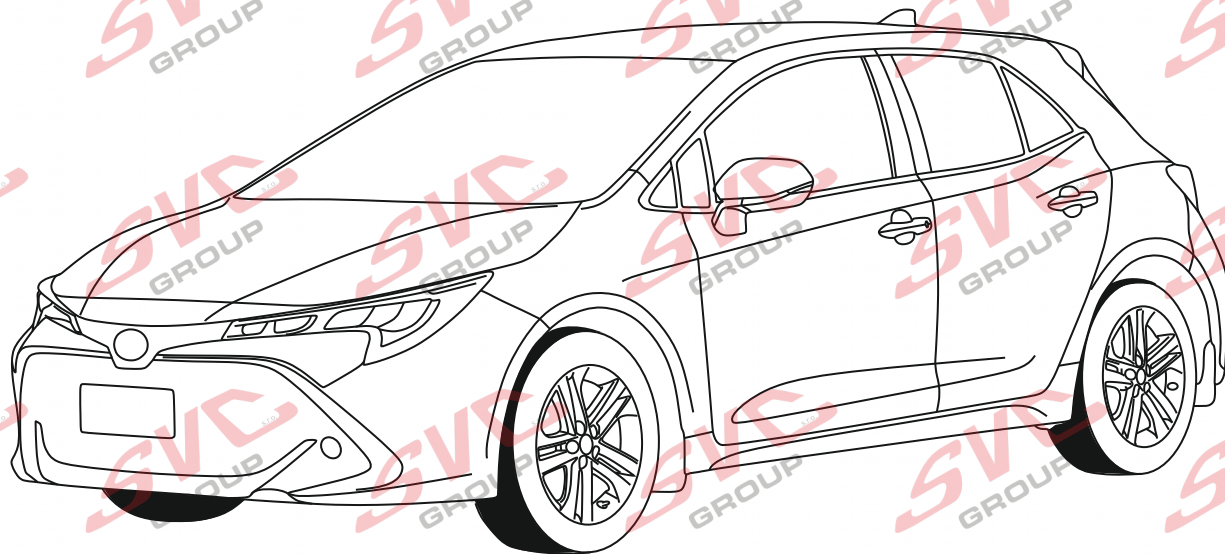
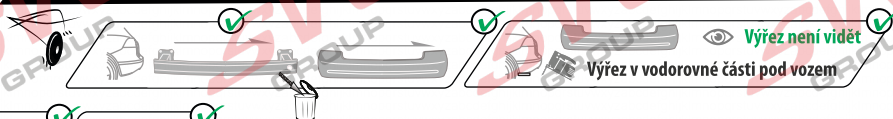

CZ Pro podrobné montážní instrukce a podmínky výroby si naskenujte QR kód
 SK Pre podrobné montážne pokyny a podmienky produktu si môžete skenovať QR kód
 GB For detailed installation instructions and product conditions, scan the QR code
 DE Scannen Sie den QR-Code, um detaillierte Installationsanweisungen und Produktbedingungen zu erhalten
 FR Pour des instructions d'installation détaillées et les conditions du produit, scannez le code QR
 ITA Per istruzioni di installazione dettagliate e condizioni del prodotto, eseguire la scansione del codice QR
 PL Aby uzyskać szczegółowe instrukcje dotyczące instalacji i warunki produktu, zeskanuj kod QR
 SP Para obtener instrucciones detalladas de instalación y condiciones del producto, escanee el código QR
 NL Voor gedetailleerde installatie-instructies en productvoorwaarden, scan de QR-code
 FIN Tarkemmat asennusohjeet ja tuotteen ehdot on tarkistettava QR-koodilla
 HU A részletes telepítési utasítások és a termék feltételei között olvassa el a QR kódot
 SLO Za podrobna navodila za namestitvev in pogoje izdelka skenirajte kodo QR
 RU Подробные инструкции по установке и условиям продукта отсканируйте QR-код.

SVC GROUP ©-11/19

e-mail: svc@svcgroup.cz Tel.: +420 491421021 +420 491421022 mob.: +420 603360607



23/6002



1650/90 D 8,77



55R 01-0 491



1,5->2,0 h

2->2,5 h



VTZ 1.001-503

16,6



A-503-2021



VTZ 1.002-503

17,2



V-503-2021



VTZ 1.002-503

18,8



AV-503-2021

M12x40 G10.9 2ks

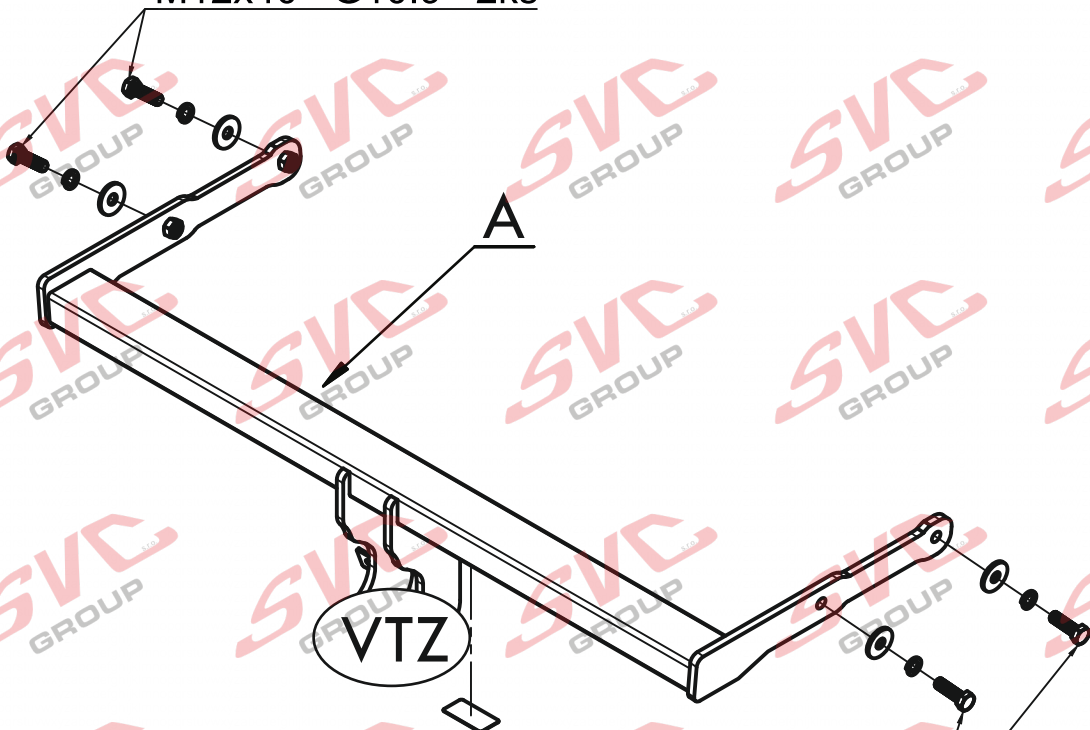

M12x40 G10.9 2ks

	A	x1		M12x40 G10.9	4ks
				Ø12	4ks
Držák zásuvky POD ŠROUB	B	x1		Ø12	4ks





Toyota Corolla HB

(E21)



01/2019 ->



VTZ 1.001-503



VTZ 1.002-503



VTZ 1.002-503

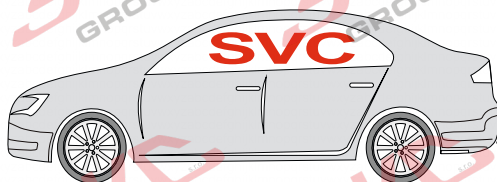

90

1 650

D=

7,77



kN

Classe A50-X

BRZDNI - BRAKE - GEBREMS

Piv.s Trailer

M12x40 G10.9 2ks

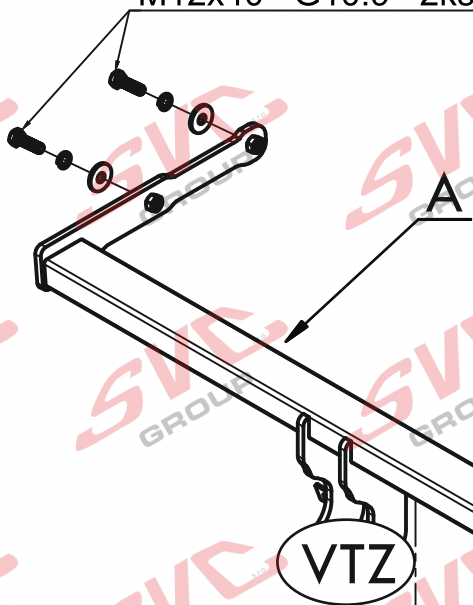

M12x40 G10.9 2ks

VTZ

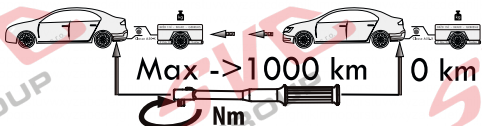
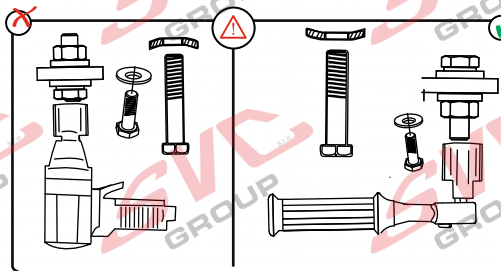

Pevnost	8,8	10,9	12,9
M6	9,7	14,3	16,1
M8	24,5	35,9	42,0
M10	48,4	71,0	83,0
M12	84,0	123,0	144,0
M14	133,0	196,0	229,0
M16	137,0	307,0	359,0



Nm



Homologace EHK 55-R

55R 01-0 491



- CZ** Informace k provozu / homologaci
- SK** Informácie na prevádzku / homologáciu
- EN** Operating / homologation information
- DE** Betriebs- / Zulassungsinformationen
- HU** Üzemeltetési / homologációs információk
- FR** Informations d'exploitation / homologatio
- IT** Informazioni sull'operazione / omologazio
- NL** Monteringsanvisningar
- ES** Instrucciones de montaje
- FIN** Montage-instructie
- SV** Asennusohjeet
- NOR** Drifts- / homologasjonsinformasjon
- PL** Informacje dotyczące pracy / homologacji
- RU** Информация о работе / омологации



SVC GROUP s.r.o.

Průmyslová zóna - 179

www.svcgroup.cz

Tel.: +420 491 421 021

+420 491 421 022

547 01 Náchod-ČR

e-mail: svc@svcgroup.cz

mob.: +420 603 360 607

QR

o

QR 00

o

Q

Q

o

M

Q

o

o

o

o

o

o

o

o

o

o

o

o

o

o

o

o

o

o

o

o

o

o

o

o

SVC GROUP ©- 05/19



Toyota Corolla HB

(E21)

01/2019 ->

N-1

CS Montážní návod

Pro podrobné montážní instrukce a podmínky výrobku si naskenujte QR kód

1. Odmontujte zadní světla, nárazník a jeho plechovou výztuhu. (Nebude již zapotřebí).
2. Do otvorů v nosnících vsuňte tažné zařízení a přichyťte 4 šrouby M12x40 (10.9). Poté tažné zařízení vyrovnejte a dotáhněte dle utahovacích momentů.
3. Namontujte zpět všechny díly odmontované v bodě č. 1.

EN Installation instructions

For detailed installation instructions and product conditions, scan the QR code

1. Remove rear lights, bumper and its sheet stiffener (it is no longer needed).
2. Insert the tow bar into the openings in vehicle beams and fasten it with four M12x40 screws (10.9). Then, align all the parts of the tow bar and tighten them to prescribed torques.
3. Reinstall all the parts removed within the step 1.

SK Montážny návod

Pre podrobné montážne pokyny a podmienky produktu si môžete skenovať QR kód

1. Demontirajte zadnje luči, odbijač in njegovo pločevinasto ojačitev (le-ta ne bo več potrebna).
2. Vlečno kljuko vstavite v luknje v nosilcih in jo pritrdite s 4 vijaki M12x40 (10.9). Nato pa poravnajte vlečno kljuko in jo zategnite glede na zatezne momente.
3. Vse dele, demontirane v točki št. 1, montirajte nazaj.

DE Montageanleitung

Scannen Sie den QR-Code, um detaillierte Installationsanweisungen und Produktbedingungen zu erhalten

1. Die Hecklichter, Stoßstange und deren Blechverstrebung ausbauen (diese wird nicht mehr benötigt).
2. In die Öffnungen in den Trägern die Zugeinrichtung einsetzen und mit 4 Schrauben M12x40 (10.9) befestigen. Die Zugeinrichtung anschließend ausrichten und mit den entsprechenden Anzugsmomenten festziehen.
3. Alle im Punkt Nr. 1 ausgebauten Teile wieder einbauen.

PL Instrukcja montażu

Aby uzyskać szczegółowe instrukcje instalacji i warunki produktu, zeskanuj kod QR

1. Demontujemy tylne lampy, zderzak i jego stalowe wzmocnienie (nie będzie już więcej potrzebne).
2. Do otworów w belkach wsuwamy urządzenie holownicze i przymocowujemy je 4 śrubami M12x40 (10.9). Potem urządzenie holownicze ustawiamy prosto i dokręcamy z zachowaniem zalecanych momentów dokręcania.
3. Montujemy ponownie wszystkie części zdemontowane w punkcie nr 1.

FR Notice de montage

Pour des instructions d'installation détaillées et les conditions du produit, scannez le code QR

1. Déposer les feux arrières, le pare-chocs et son renfort en tôle. (ce dernier ne sera plus nécessaire).
2. Insérer le dispositif d'attelage dans les ouvertures des longerons et fixer à l'aide de 4 vis M12x40 (10.9). Aligner le dispositif d'attelage et serrer aux couples préconisés.
3. Reposer toutes les pièces déposées à la section n°1.

FI Asennusohje

Tarkemmat asennusohjeet ja tuotteen ehdot on tarkistettava QR-koodilla

1. Irrota takavalot, puskuri ja sen peltijäykiste. (Sitä ei enää tarvita).
2. Työnnä vetolaite palkeissa oleviin reikiin ja kiinnitä 4 ruuvilla M12x40 (10.9). Suorista vetolaite ja kiristä kiristysmomenttien mukaisesti.
3. Asenna takaisin kaikki kohdassa 1. irrotetut osat.



SVC GROUP s.r.o. Průmyslová zóna - 179 547 01 Náchod-ČR

www.svcgroup.cz
e-mail: svc@svcgroup.czTel.: +420 491 421 021
+420 491 421 022
mob.: +420 603 360 607

SVC GROUP © - 05/19

QR kódem stáhnete rozšířený montážní návod / With QR code you can download the extended assembly instructions



Toyota Corolla HB

(E21)

01/2019 ->

N-1

ES Manual de montaje

Para obtener instrucciones detalladas de instalación y condiciones del producto, escanee el código Q

1. Desmonte los focos traseros, parachoques y su refuerzo de chapa (no hará falta más).
2. En los orificios en los soportes inserte el equipo de tiro sujetándolo con 4 tornillos M12x40 (10.9). Después enderece el equipo de tiro y apriete según los pares de apriete.
3. Monte de vuelta todas las piezas desmontadas según el punto No. 1.

IT Istruzioni dimontaggio per la

Per istruzioni di installazione dettagliate e condizioni del prodotto, eseguire la scansione del codice

1. Smontare i fanali posteriori, il paraurti e il suo rinforzo di lamiera (non sarà più necessario).
2. Nei fori nei supporti inserire il dispositivo di traino e fissare con 4 bulloni M12x40 (10.9). Quindi allineare il dispositivo di traino e serrare con le coppie di serraggio prescritte.
3. Rimontare tutti i componenti smontati nel punto 1.

NO Monteringsanvisning

For installasjonsinstruksjoner og produktbetingelser, skann QR-koden

1. Demontér baklys, støtfanger og dens metallplateforsterkning (den vil ikke lenger trenges).
2. Stikk trekkutstyret inn i hullene i bæreelementene og fest ved hjelp av fire skruer av typen M12x40 (10.9). Balansér deretter trekkutstyret og stram i samsvar med de foreskrevde tiltrekkingmomentene.
3. Montér på plass igjen alle de delene som ble demontert i punkt nr. 1.

NL Montagehandleiding

Scan de QR-code voor installatie-instructies en instructies voor productcondities

1. Verwijder de achterlichten, bumper en de stalen versterkingsdeel (deze is niet langer nodig).
2. Steek de trekhaak in de gaten in de balken en schroef deze met behulp van 4 schroeven M12x40 (10.9) aan. Lijn de trekhaak uit en schroef deze overeenkomstig de aanbevolen aanhaalmomenten aan.
3. Plaats alle volgens punt 1 verwijderde onderdelen terug.

HU Szerelési útmutató

A telepítési és a termékfeltételekkel kapcsolatos útmutatásokat olvassa be a QR-kódot

1. Távolítsa el a hátsó lámpákat, a lökhárítót és a fém tartót (erre már nem lesz szüksége).
2. Helyezze a hordozók nyílásába a vonóhorgot és fogassa fel 4 M12x40 csavarral (10.9). Most igazítsa meg mindent, és húzza meg a csavarokat a meghúzási nyomatéknak megfelelően.
3. Helyezze vissza az 1. lépésben eltávolított alkatrészeket.

RU Инструкция по монтажу

Подробные инструкции по установке и условиям продукта отсканируйте QR-к

1. Снимите задние фонари, бампер и его металлический усилитель (он больше не потребуется).
2. В отверстия в балках вставьте фаркоп и закрепите 4 болтами M12x40 (10.9). Выровняйте фаркоп и затяните в соответствии с предписанными моментами затяжки.
3. Верните на место все части, демонтированные согласно пункту 1.



SVC GROUP s.r.o. Průmyslová zóna - 179 547 01 Náchod-ČR

www.svcgroup.cz
e-mail: svc@svcgroup.czTel.: +420 491 421 021
+420 491 421 022
mob.: +420 603 360 607

QR kódem stáhnete rozšířený montážní návod / Verwenden Sie den QR-Code, um die erweiterte Montageanleitung herunterzuladen

SVC GROUP ©- 05/19

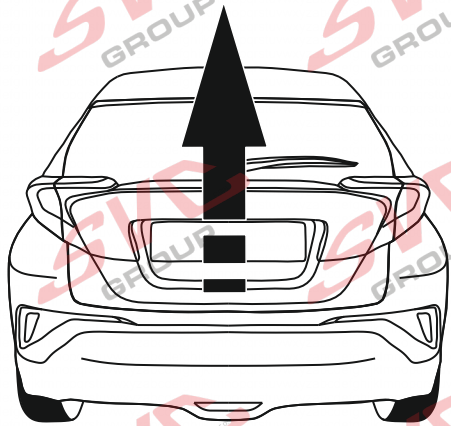

Montážní návod
 Montážny návod
 Installation instructions
 Installationsanleitung
 Instructions d'installation
 Инструкция по установке

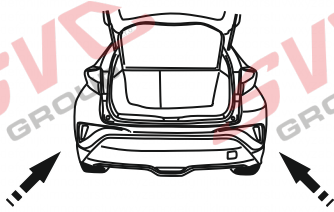
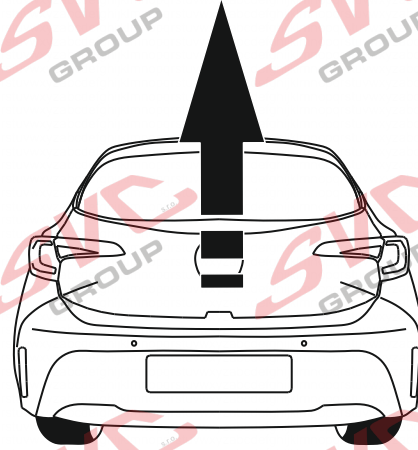

Toyota C-HR

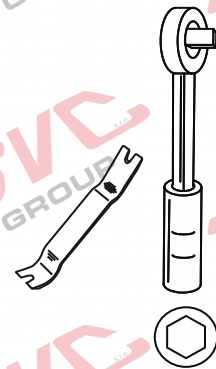
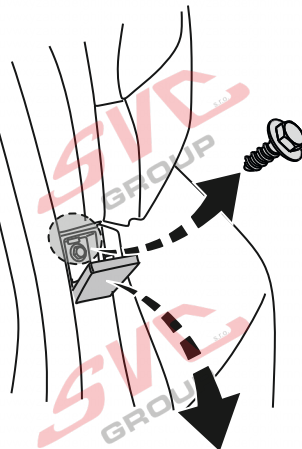

10

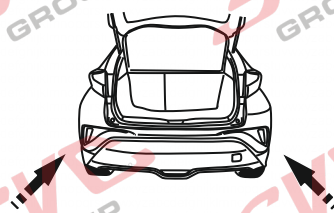

Toyota C-HR

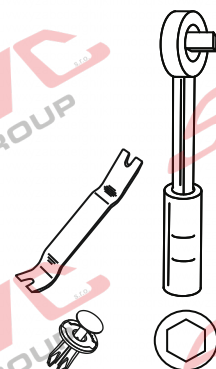
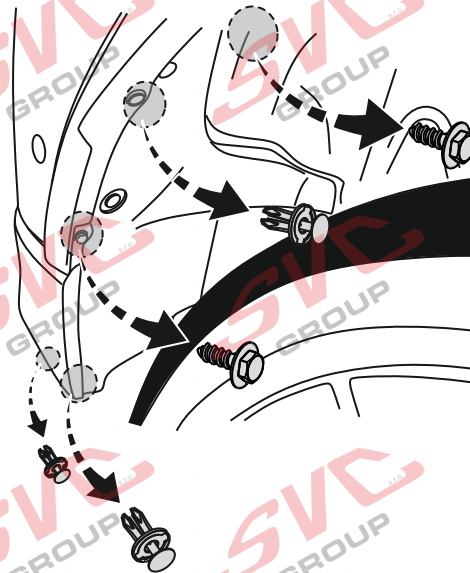

10



4.

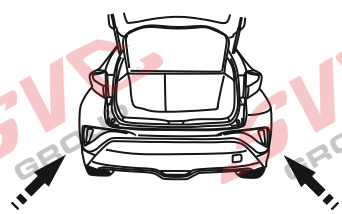

Toyota C-HR

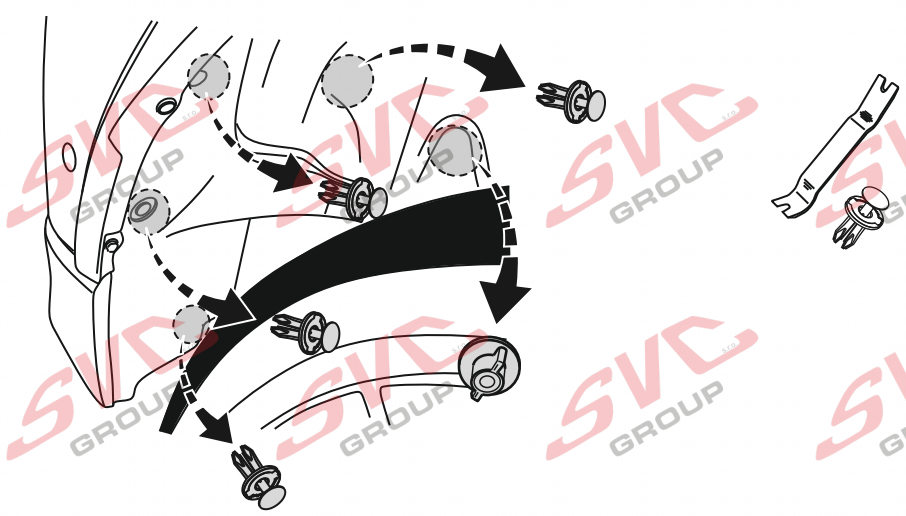

5.

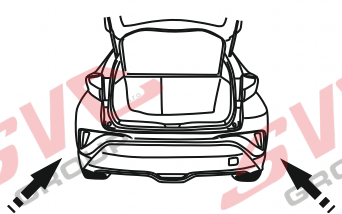

Toyota C-HR

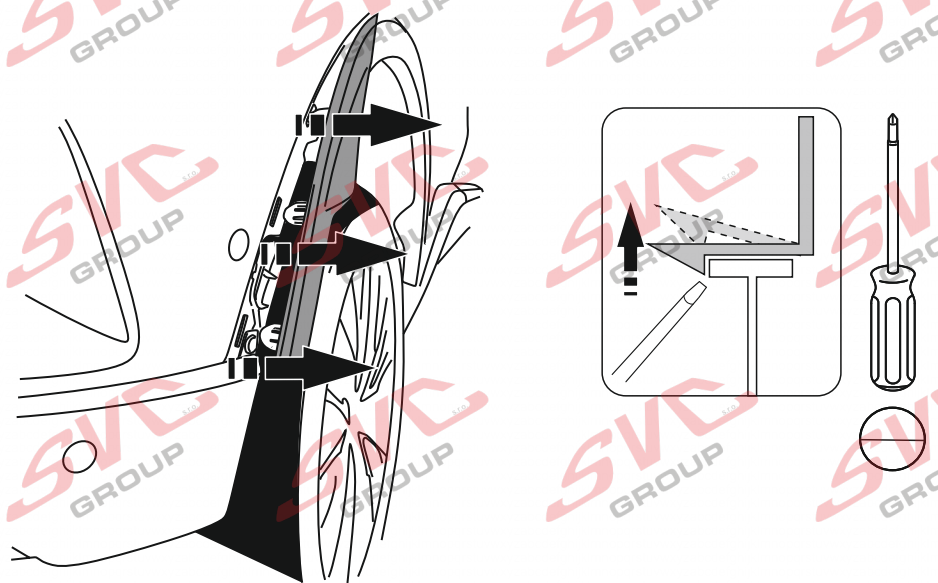

6.

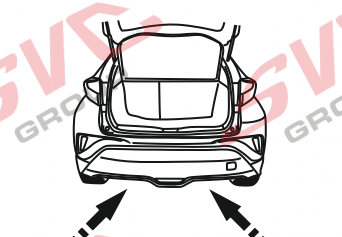

Toyota C-HR

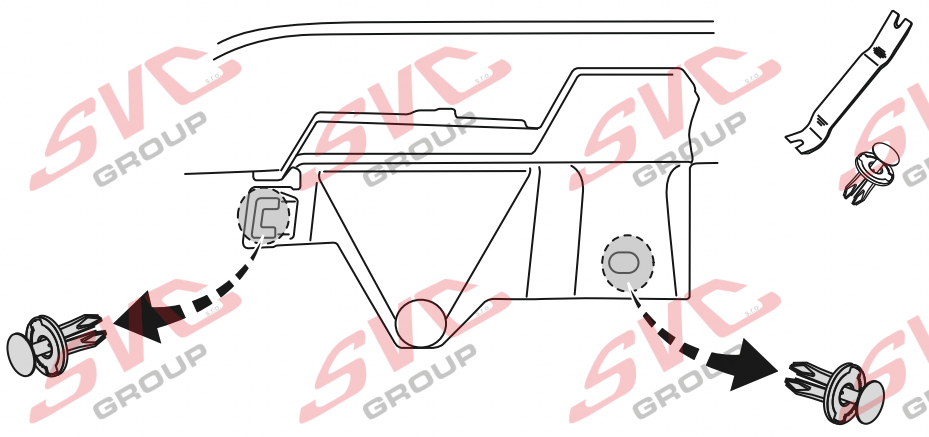

7.

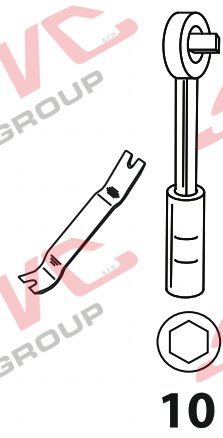
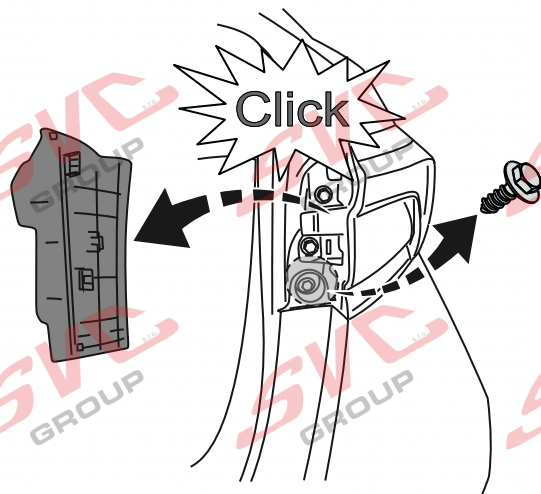
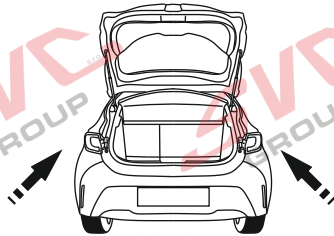

Toyota Corolla



8.

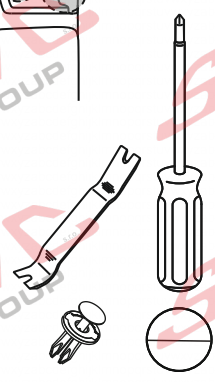
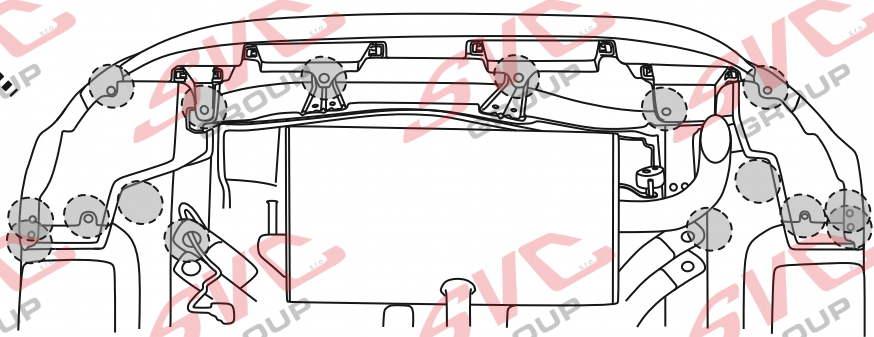
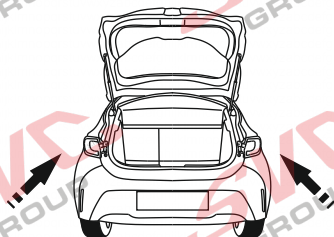

Toyota Corolla



9.

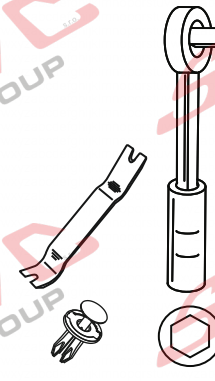
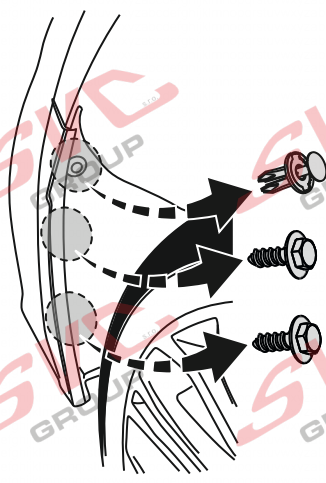
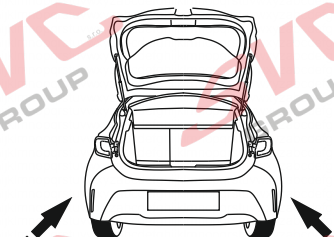

Toyota Corolla





10.

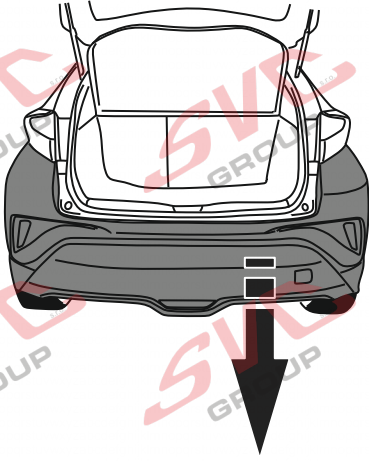

11.

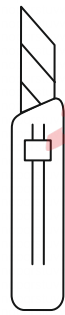
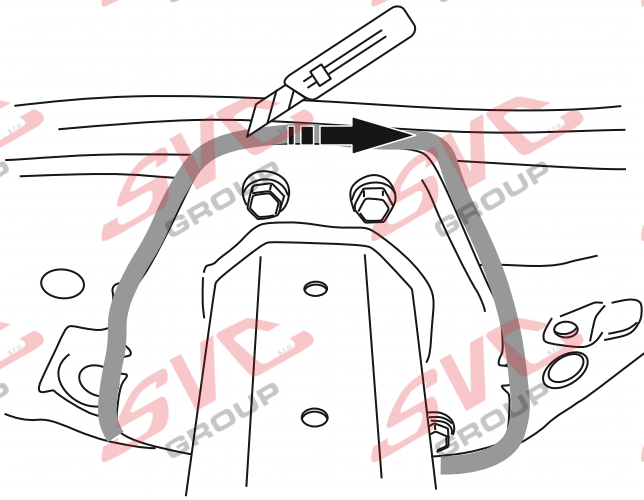
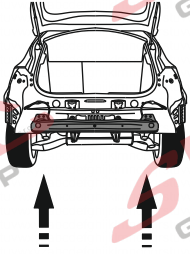

12.

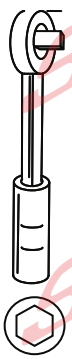
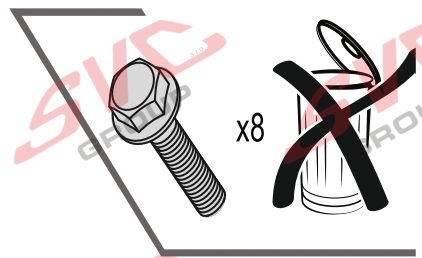
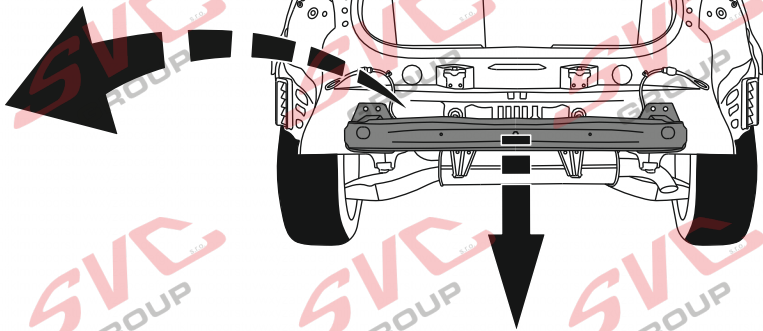

12



13.

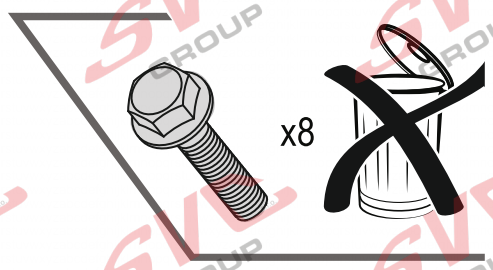
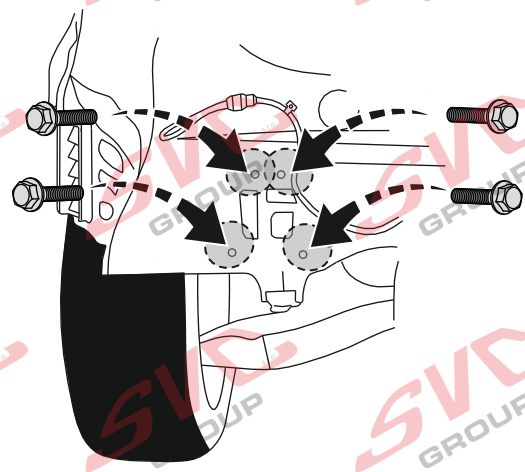
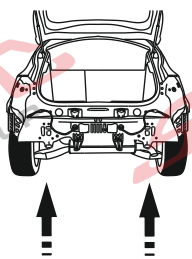

x8

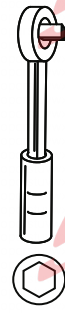

12

14.

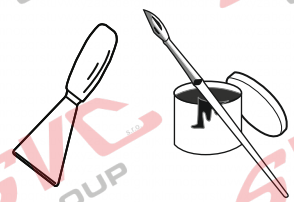
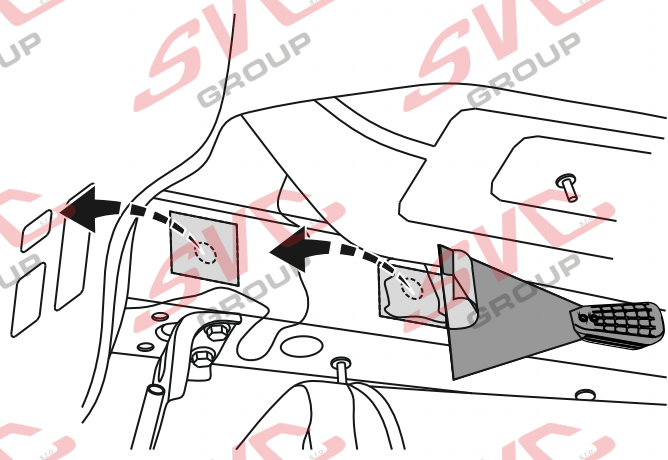
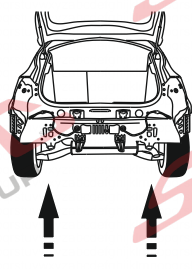

15.

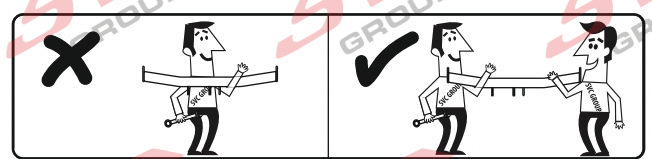
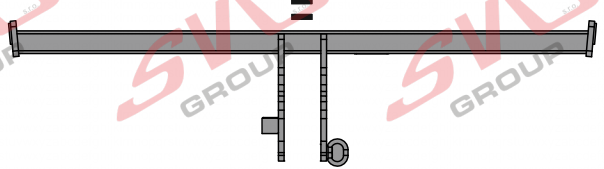
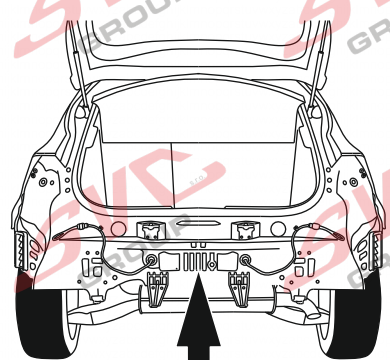

16.

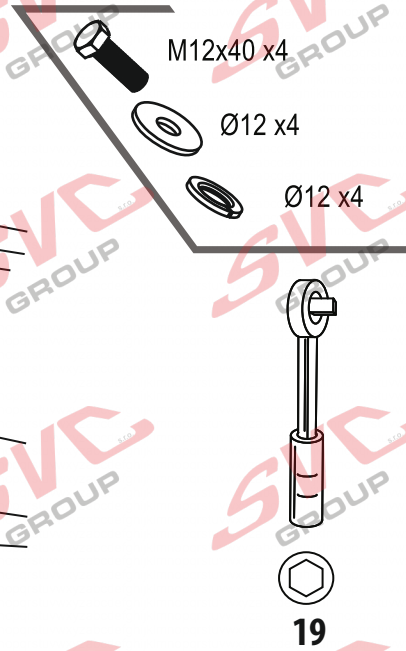
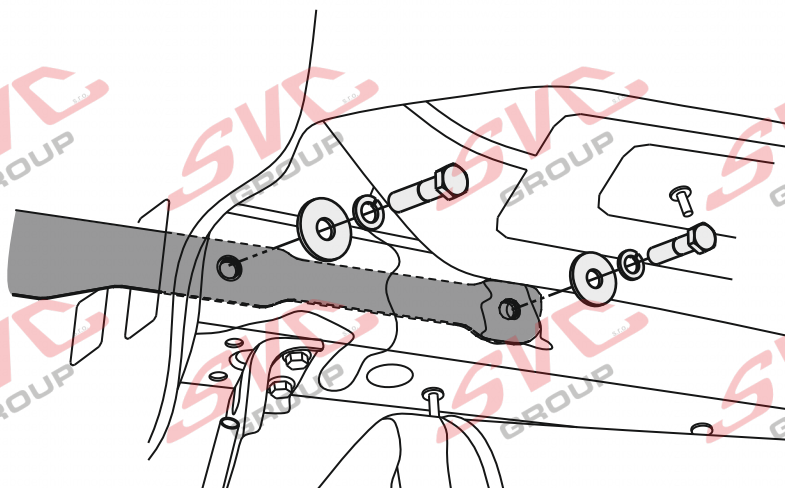
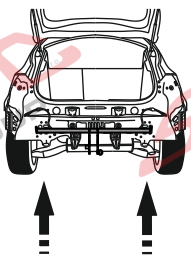

17.

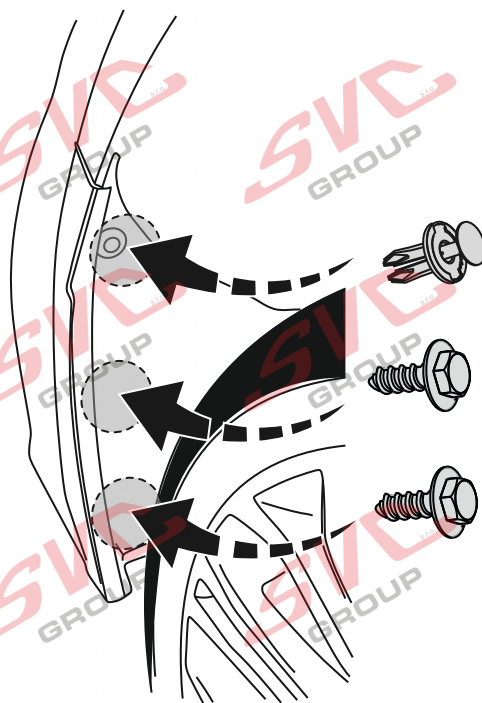
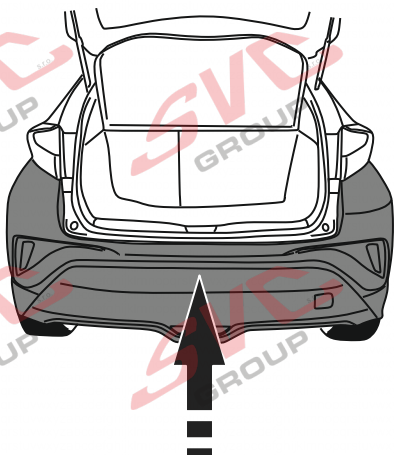

18.

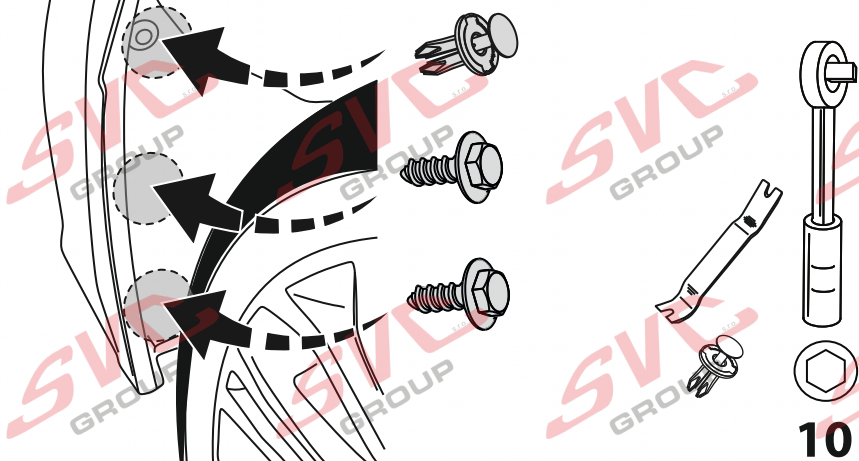
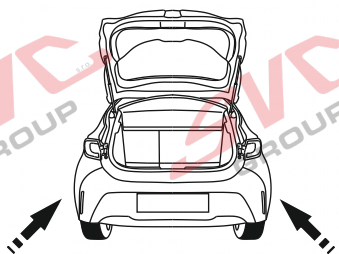

Toyota Corolla



19.

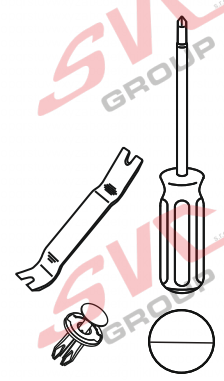
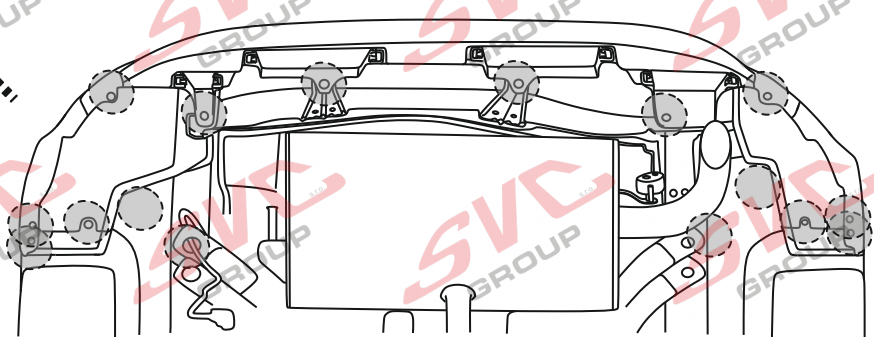
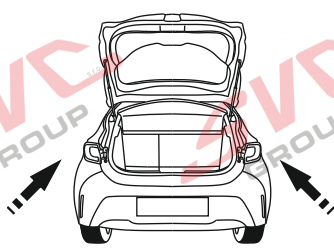

Toyota Corolla

20.

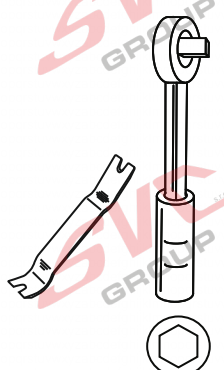
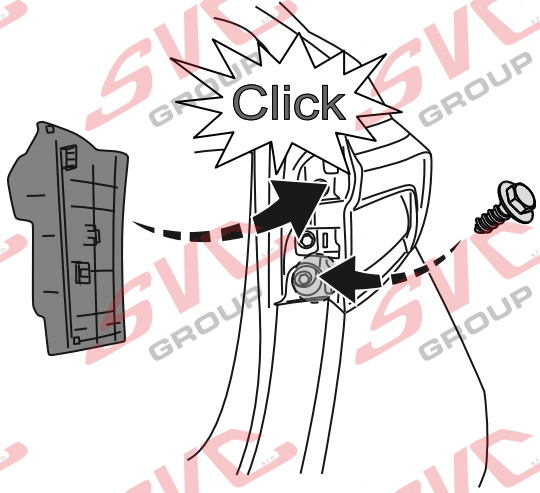
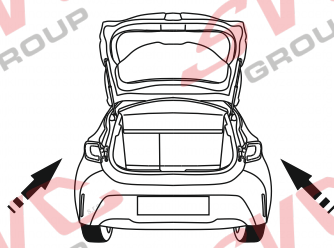

Toyota Corolla

21.

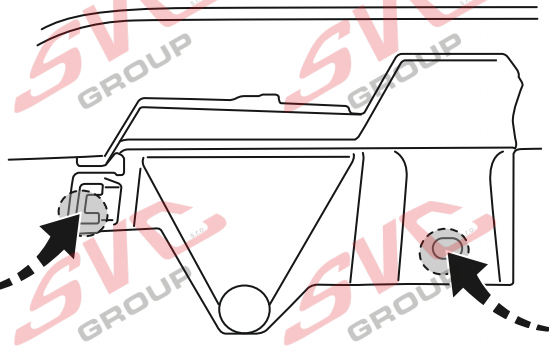
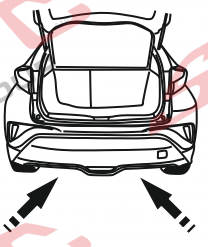

Toyota C-HR

22.

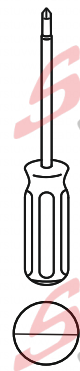
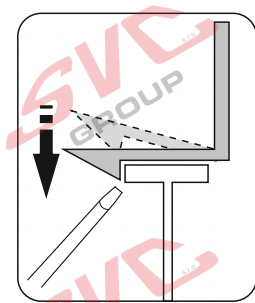
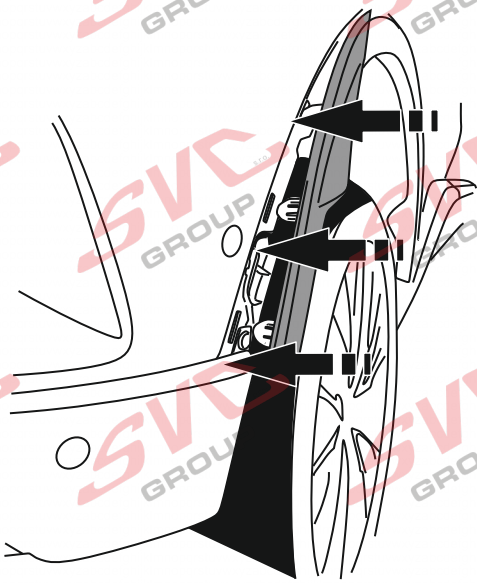
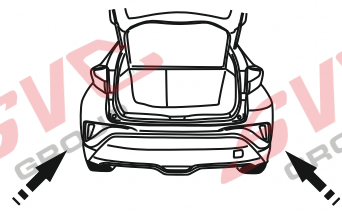

Toyota C-HR

23.

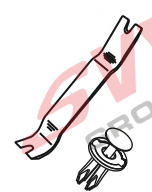
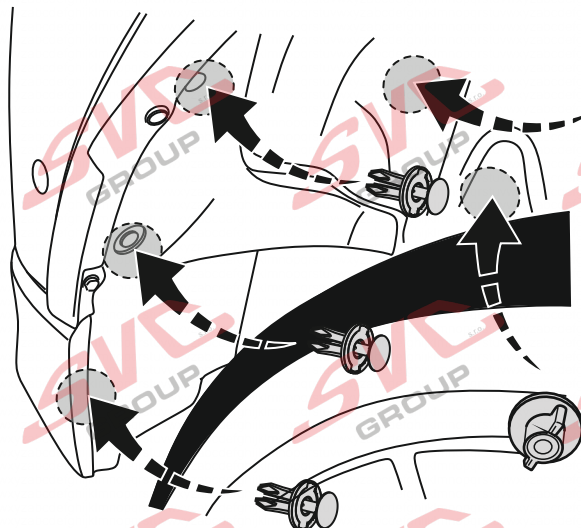
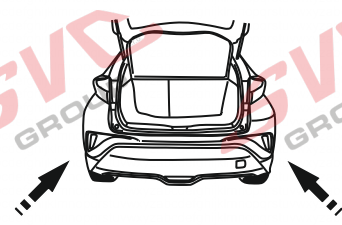

Toyota C-HR

24.

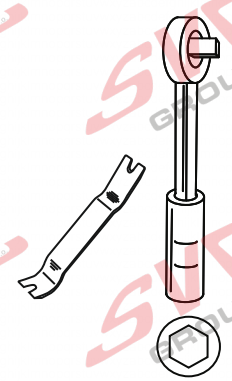
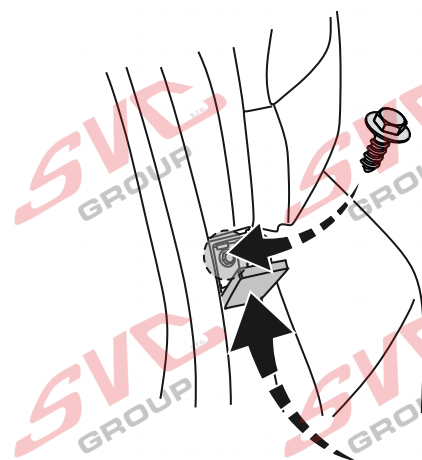
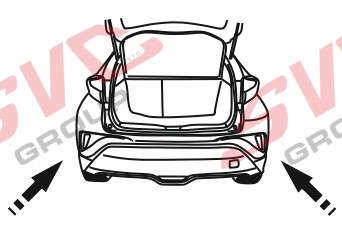

Toyota C-HR





25.

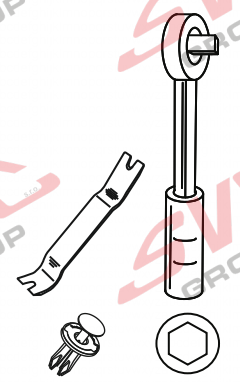
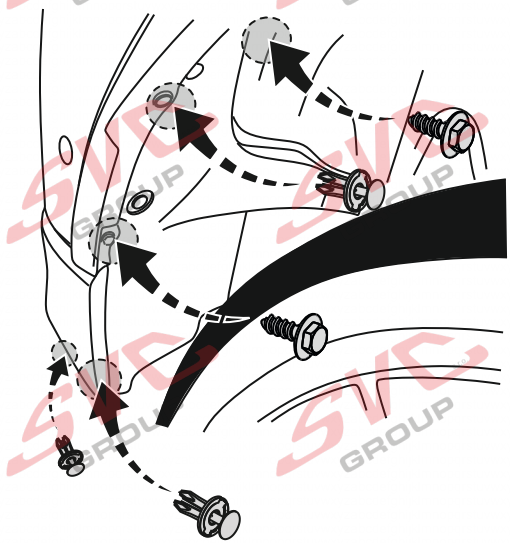
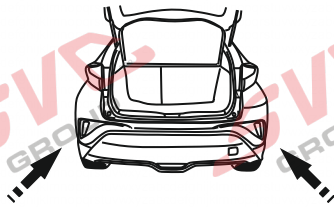

10

Toyota C-HR



26.

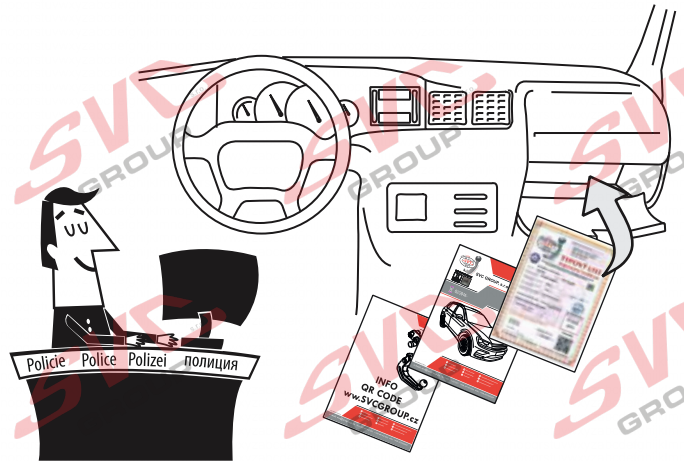
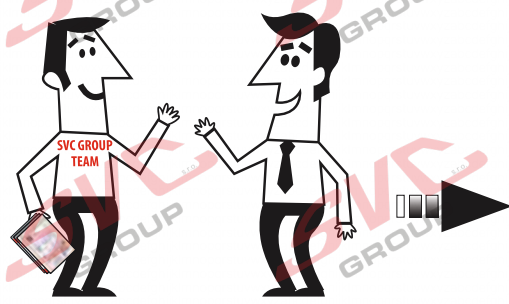
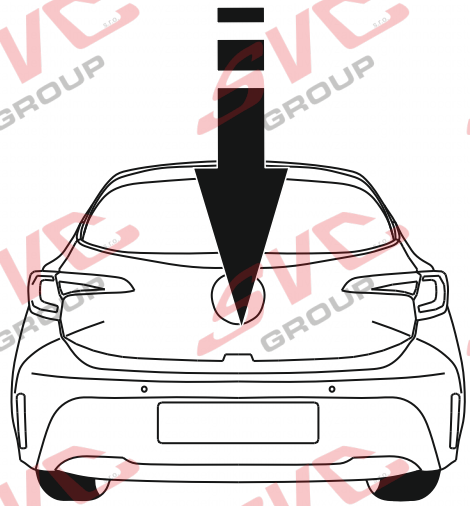
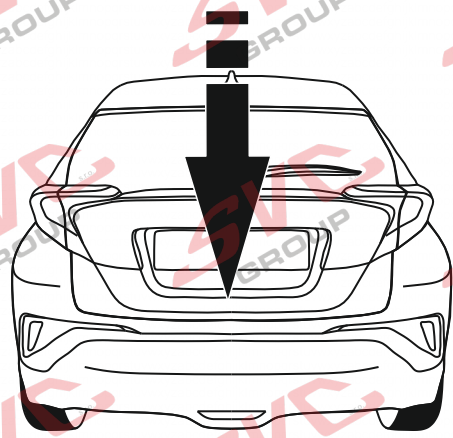

SVC GROUP

Děkuje za důvěru / Āakuje za dōveru
Thank you for your trust / Danke Für dein Vertrauen
Merci pour votre conance / Grazie per la tua ducia
Tankewol foar jo fertrouwen / Спасибо за ваше доверие

Registrace / Registrācia
Registration / Registrierung
Inscription / Registrazione
Rekisterōinti / Регистрāция

SVC GROUP ©-4014



SVC GROUP s.r.o.

Průmyslovā zōna - 179
547 01 Nāchod-ĀR

www.svcgroup.cz
e-mail: svc@svcgroup.cz

Tel.: +420 491421021
+420 491421022
mob.: +420 603360607
SVC GROUP ©- 05/19

QR kōdem stāhnete rozšīřeny montāžnī nāvod / Met QR-code kunt u de uitgebreide montage-instructies downloaden

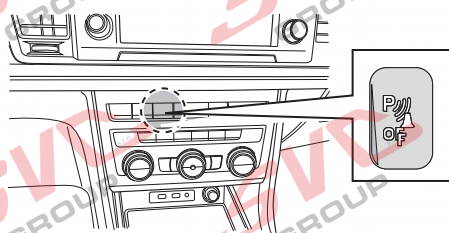
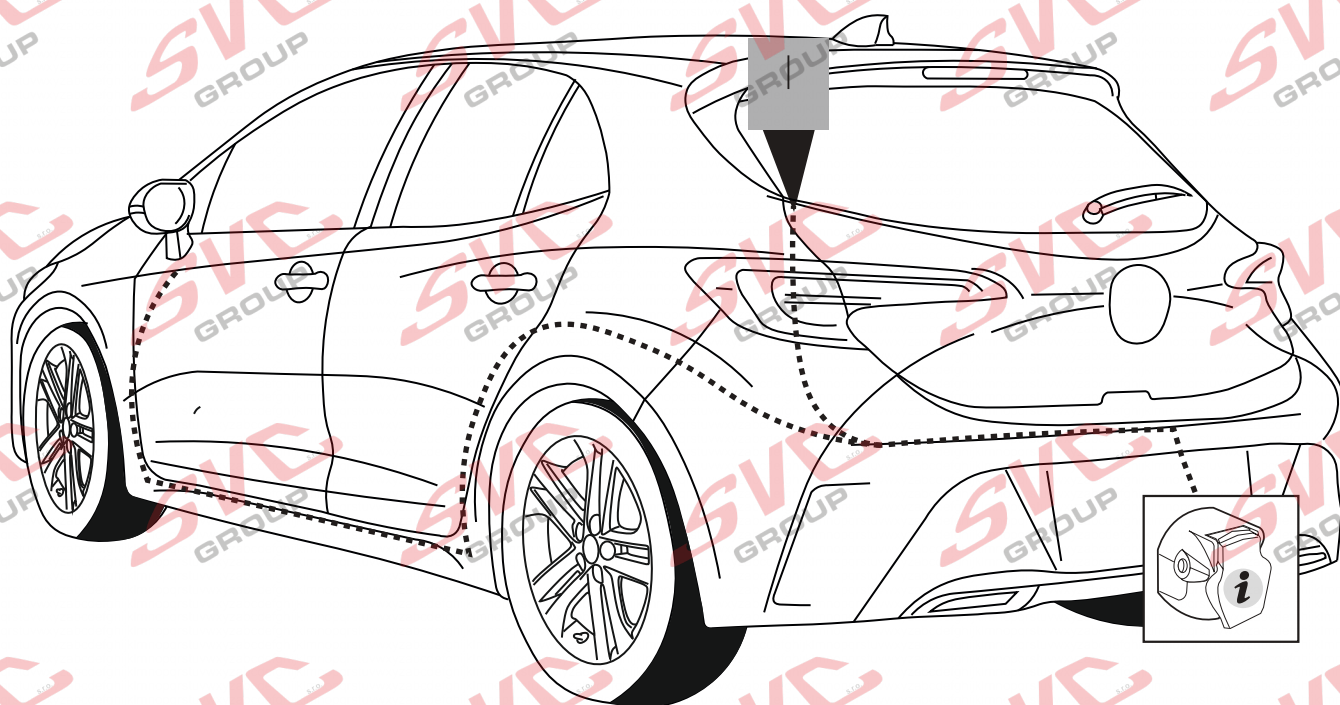

Informace pro odpojování couvacích senzorů PDC pro o tažné zařízení

Vypínač pro vypínání couvacích senzorů PDC je umístěn na palubní desce vozu.

Nemusíte tedy pracně na elektro instalaci vozu napojovat odpojování couvacích senzorů PDC a zpětných kamer od elektro přípojky tažných zařízení.

Pokud chcete senzory vypnout, použijte vypínač na palubní desce.

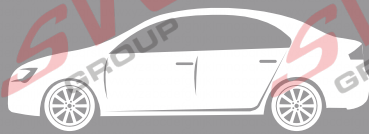

T-2

NL Monteringsanvisningar

Het product is vervaardigd volgens de toepasselijke EHK-55 R-normen voor verkoop in EU-landen. Informatie over het gebruik, de werking en de garanties voor de trekhaak vindt u op onze website, www.svcgroup.com *Technische informatie > Trekhaak > Algemene gebruiksvoorwaarden*. Of download ze via QR-cod
Het sleepapparaat wordt geleverd met een TYPE BLAD. Dit gegevensblad wordt gebruikt om het product in het voertuigregistratiedocument in te voeren en bevat de basisvoorwaarden voor het gebruik van het product. Het gegevensblad dient ook als garantiepers, dus bewaar het in de voertuigdocumentatie.

ES Instrucciones de montaje

El producto se fabrica de acuerdo con los estándares EHK-55 R aplicables para la venta en países de la UE. Puede encontrar información sobre el uso, el funcionamiento y las garantías de la barra de remolque en nuestro sitio web, www.svcgroup.com *Información técnica > Enganche de remolque > Condiciones generales de uso*. O descárguelos a través de QR-cod
El dispositivo de remolque se suministra con una HOJA DE TIPO. Esta hoja de datos se utiliza para ingresar el producto en el documento de registro del vehículo y contiene las condiciones básicas para el uso del producto. La hoja de datos también sirve como una prensa de garantía, por lo tanto, consérvela en la documentación del vehículo.

FIN Montage-instructie

Tuote on valmistettu EU-maissa myytävien EHK-55 R -standardien mukaisesti. Tietoja vetokoukun käytöstä, käytöstä ja takuista löytyy verkkosivuiltamme www.svcgroup.com *Tekniset tiedot > Vetokoukku > Yleiset käyttöolosuhteet*. Tai lataa ne QR-koodin kautta
Hinauslaite toimitetaan TYYPPI-ARKKI. Tätä lomaketta käytetään tuotteen syöttämiseen ajoneuvon rekisteröintitodistukseen, ja se sisältää tuotteen käytön perusedellytykset. Tietolomake toimii myös takuupuristimena, joten säilytä se ajoneuvon dokumenteissa.

SL

Izdelek je izdelan po veljavnih standardih EHK-55 R za prodajo v državah EU. Informacije o uporabi, delovanju in garancijah za vle éno ploš é najdete na našem spletnem mestu www.svcgroup.com *Tehni éni podatki > Vle éna kljuka > Splošni pogoji uporabe*. Ali pa jih prenesite preko QR-kod
Vle éna naprava je opremljena s TIPNIM LISTOM. Ta podatkovni list se uporablja za vnos izdelka v registracijski dokument vozila in vsebuje osnovne pogoje za uporabo izdelka. Podatkovni list služi tudi kot garancijski tisk, zato ga hranite v dokumentaciji vozila.

NOR Drifts- / homologasjonsinformasjon

Produktet er produsert i henhold til gjeldende EHK-55 R standarder for salg i EU-land. Informasjon om bruk, drift og garantier for tilhengerfeste finner du på vår hjemmeside, www.svcgroup.com *Teknisk informasjon > Tilhengerfeste > Generelle bruksbetingelser*. Eller last dem ned via QR-koding
Tøaenordningen leveres med TYPEBLAD. Dette databladet brukes til å oppgi produktet i kjøretøyets registreringsbevis og inneholder de grunnleggende betingelsene for bruk av produktet. Databladet fungerer også som garantipresse, så hold det i bilens dokumentasjon.

PL Informacje dotyczące pracy / homologacji

Produkt jest wytwarzany zgodnie z obowi ázuj ácymi normami EHK-55 R na sprzedaŹ w krajach UE. Informacje na temat u"ytowania, obslugi i gwarancji na hak holowniczy mo"na znale"1 na naszej stronie internetowej www.svcgroup.com *Informacje techniczne > Zaczep holowniczy > Ogólne warunki u"ytowania*. Lub pobierz je za pomoc á lodu QR
Urządzenie holownicze jest dostarczane z ARKUSZEM TYPU. Ta karta danych slu"y do wpisania produktu do dokumentu rejestracyjnego pojazdu i zawiera podstawowe warunki u"ytowania produktu. Karta danych slu"y równie" jako prasa gwarancyjna, dlatego przechowuj j á w dokumentacji pojazdu.

RU Информация о работе /омологации

El producto se fabrica de acuerdo con los estándares EHK-55 R aplicables para la venta en países de la UE. Puede encontrar información sobre el uso, el funcionamiento y las garantías de la barra de remolque en nuestro sitio web, www.svcgroup.com *Información técnica > Enganche de remolque > Condiciones generales de uso*. O descárguelos a través de QR-cod
El dispositivo de remolque se suministra con una HOJA DE TIPO. Esta hoja de datos se utiliza para ingresar el producto en el documento de registro del vehículo y contiene las condiciones básicas para el uso del producto. La hoja de datos también sirve como una prensa de garantía, por lo tanto, consérvela en la documentación del vehículo.



SVC GROUP s.r.o.

Průmyslová zóna - 179
547 01 Náchod-ČRwww.svcgroup.cz
e-mail: svc@svcgroup.czTel.: +420 491 421 021
+420 491 421 022
mob.: +420 603 360 607

SVC GROUP ©- 05/19

QR 00 QR 00 0

Q Q o C é o éé QR p

é é é C é é é é

o C é é C é é é

é é é C é é é é

o C é é C é é é

é é é C é é é é

o C é é C é é é

é é é C é é é é

o C é é C é é é

é é é C é é é é

o C é é C é é é



CZ Pozor informace k záruce
SK Pozor informácie k záruke
EN Note the warranty information
DE Beachten Sie die Garantieinformationen

HU Vegye gyelembe a jótállási információkat
FR Notez les informations de garantie
IT Nota le informazioni sulla garanzia
NL Let op de garantie-informatie

ES Atención
FIN Huomio
PL Uwaga
RU ((((((

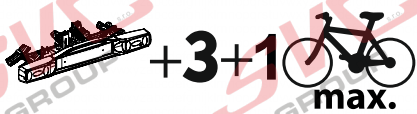
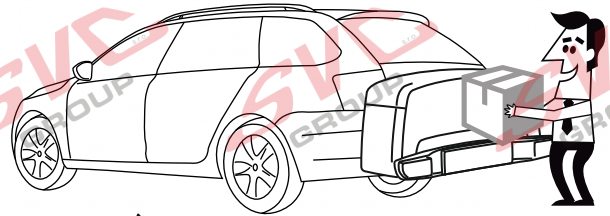
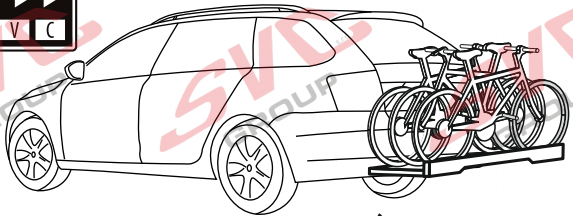

max. manual

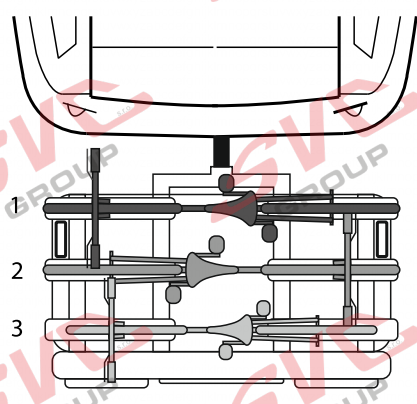

max. manual

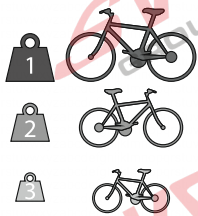

max. manual

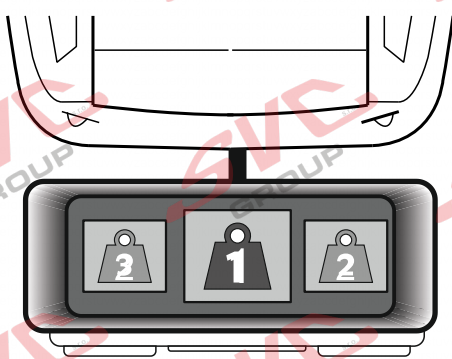

MAX. 5 km/h

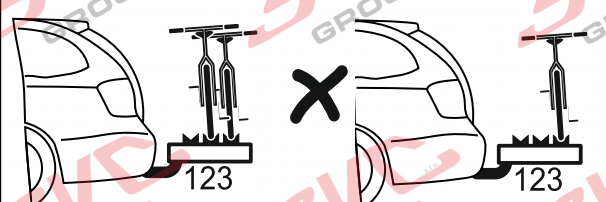
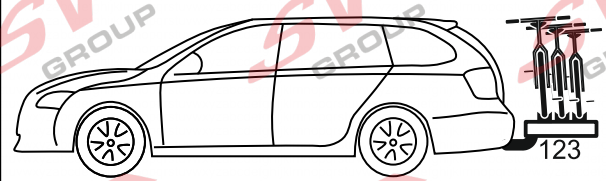
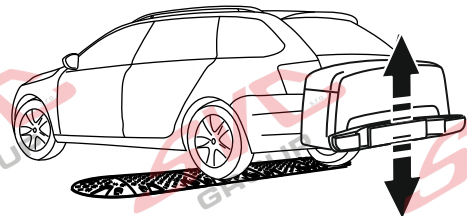
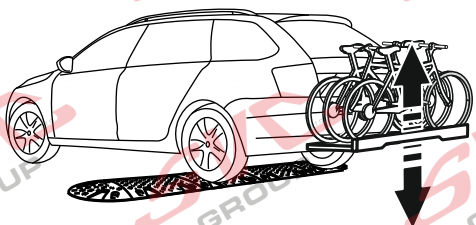

Vysokov 179
 547 01 Náchod, Česká Republika

+420 603 360 607 +420 491421021



www.svcgroup.cz

Service Vitver Centrum